

## Window Inverter AC

# USER MANUAL

MAW08S1VWWT-T  
MAW10S1VWWT-T  
MAW12S1VWWT-T  
MAW14S1VWWT-T



 SmartHome

Download the app  
& activate product

 Download on the  
App Store

 GET IT ON  
Google Play



Warning notices: Before using this product, please read this manual carefully and keep it for future reference. The design and specifications are subject to change without prior notice for product improvement. Consult with your dealer or manufacturer for details.

The diagram above is just for reference. Please take the appearance of the actual product as the standard.

## THANK YOU FOR CHOOSING MIDEA!

Before using your new Midea product, please review this manual thoroughly to ensure safe and effective operation of its features and functions.

# CONTENTS

CONTENTS .....	01
SAFETY PRECAUTIONS .....	02
WHAT IS IN THE BOX .....	12
BEFORE GETTING STARTED .....	13
INSTALLATION OVERVIEW .....	14
GET TO KNOW THE AC .....	21
GET TO KNOW THE FEATURES .....	22
CLEANING & MAINTENANCE .....	25
TROUBLESHOOTING TIPS .....	26
REMOTE CONTROL .....	28
APP INSTRUCTIONS .....	33
WARRANTY .....	40

# SAFETY PRECAUTIONS

This manual contains helpful tips for the proper use and maintenance of the air conditioner. Implementing preventive care can save significant time and money throughout the unit's lifespan.

To prevent injury to the user, or personal and property damage, these instructions must be followed.

Incorrect operation due to ignoring of instructions may cause harm or damage. The level of risk is shown by the following indications.

## Explanation of Symbols

### **WARNING**

This symbol indicates a hazardous situation which, if not avoided, could result in death or serious injury.

### **CAUTION**

This symbol indicates a hazardous situation which, if not avoided, could result in minor or moderate injury.

### **WARNING**

- Plug in power plug properly. Otherwise, it may cause electric shock or fire due to excess heat generation. Do not operate or stop the unit by inserting or pulling out the power plug. It may cause electric shock or fire due to heat generation. Do not damage or use an unspecified power cord. It may cause electric shock or fire. If the power cord is damaged, it must be replaced by the manufacturer, an authorized service center or similarly qualified persons in order to avoid a hazard.
- Always install circuit breaker and a dedicated power circuit. Incorrect installation may cause fire and electric shock. Do not operate with wet hands or in damp environment. It may cause electric shock. Airflow should not be directed solely at room occupants, as this could create a hazardous situation.
- Always ensure effective grounding. Incorrect grounding may cause electric shock. Do not allow water to flow into electrical parts. Failure to do so may result in unit malfunction or electric shock. Do not modify power cord length or share the outlet with other appliances. It may cause electric shock or fire due to heat generation.
- Unplug the unit if strange sounds, smell, or smoke are present. It may cause fire and electric shock. Do not use the socket if it is loose or damaged. It may cause fire and electric shock. Do not open the unit during operation. It may cause electric shock.
- Keep firearms stored safely, as they may pose a fire risk. Do not use the power cord close to heating appliances. It may cause fire and electric shock. Do not use the power cord near flammable gas or combustibles, such as gasoline, benzene, thinner, etc. It may cause an explosion or fire.
- Ventilate room before operating air conditioner if there is a gas leakage from another appliance. It may cause explosion, fire and burns.  
Do not disassemble or modify unit. It may cause failure and electric shock.

## CAUTION

- When the air filter is to be removed, do not touch the metal parts of the unit. It may cause injury. Ventilate room well when used together with a stove, etc. Oxygen deficiency may occur.
- Do not use strong detergent such as wax or thinner but use a soft cloth. Appearance may be deteriorated due to change of product color or scratching of its surface. Do not clean the air conditioner with water. Water may enter the unit and degrade the insulation. It may cause electric shock. Do not use for special purposes. Do not use this unit to preserve precision devices, food, pets, plants, and art objects. It may cause deterioration of quality, etc.
- Cease operation and close windows during a storm or hurricane. Keeping windows open may lead to water entering the home and soaking household furniture.  
When the unit is to be cleaned, switch off and turn off the circuit breaker.
- Do not clean the unit when power is on as this may result in fire and electric shock and may cause injury.
- Always insert the filters securely. Operation without a filter may result in malfunction. Please clean filter once every two weeks.

## CAUTION

- Hold the plug by the head of the power plug when taking it out. Otherwise it may cause electric shock and damage.  
Turn off the main power switch when not using the unit for a long time. Otherwise it may cause unit malfunction or fire.
- Do not place obstacles around air-inlet or inside the air-outlet. Failure to do so may result in unit malfunction or accident. Do not place heavy objects on the power cord and make sure the power cord is not crushed. Otherwise there is a risk of fire or electric shock. Avoid drinking water drained from the air conditioner, as it may contain contaminants that could pose health risks.
- Use caution when unpacking and installing. Sharp edges could cause injury.
- If water enters the unit, turn the unit off at the power outlet and switch off the circuit breaker. Isolate supply by taking the power-plug out and contact a qualified service technician.
- This unit is not intended for use by persons (including children) with reduced physical, sensory or mental capabilities or lack of experience and knowledge, unless they have been given supervision or instruction concerning use of the unit by a person responsible for their safety.
- Children should be supervised to ensure that they do not play with the air conditioner.
- If the supply cord is damaged, it must be replaced by the manufacturer, its service agent or similarly qualified persons in order to avoid a hazard.
- The unit shall be installed in accordance with national wiring regulations.
- Installation must be performed in accordance with the requirement of NEC and CEC by authorized personnel only.
- Do not operate the air conditioner in a wet room such as a bathroom or laundry room.
- The unit with electric heater shall have at least 1 meter space to the combustible materials.
- Contact the authorized service technician for repair or maintenance of this unit.
- Contact the authorized installer for installation of this unit.

## NOTE

This air conditioner is designed to be operated under the following conditions:

Cooling operation	Outdoor temp:	64-109°F/18-43°C (64-125°F/18-52°C for special tropical models)
	Indoor temp:	60-90°F/16-32°C
Heating operation	Outdoor temp:	23-76°F/-5-24°C
	Indoor temp:	32-80°F/0-27°C

**Note:** Performance may be reduced outside of these operating temperatures.

### Operation of Current Device

The power supply cord contains a current measuring device that detects damage to the power cord. Test your power supply cord as follows:

- Plug in the air conditioner.
- The power supply cord will have TWO buttons on the plug head. Press the TEST button. A click will be heard as the RESET button pops out.
- Press the RESET button again. A click will be heard as the button engages.
- The power supply cord is now supplying electricity to the unit. (On some products this is also indicated by a light on the plug head) .

## NOTE

- The power supply cord with this air conditioner contains a current detection device designed to reduce the risk of fire.
- In the event that the power cord is damaged, it cannot be repaired – it must be replaced with a cord from the product manufacturer.
- Do not use this device to turn the unit on or off.
- Always make sure the RESET button is pushed in for correct operation.
- If the power supply cord does not reset when the TEST button is pressed or cannot be reset, it must be replaced. Please contact customer service for assistance.

### Grounding type wall receptacle

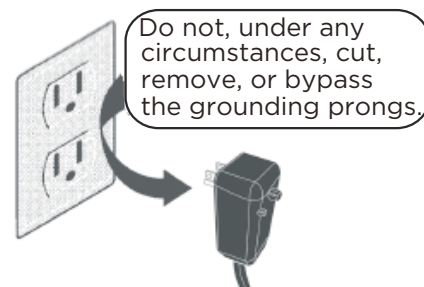

Power supply cord with 3-prong grounding plug and current detection device.

## WARNING

### Electrical Information

The complete electrical rating of the air conditioner is stated on the serial plate. Refer to the rating when checking the electrical requirements.

- Be sure the air conditioner is properly grounded. To minimize shock and fire hazards, proper grounding is important. The power cord is equipped with a three-prong grounding plug for protection against shock hazards.
- The air conditioner must be used in a properly grounded wall receptacle. If the wall receptacle is not adequately grounded or protected by a time delay fuse or circuit breaker, have a qualified electrician install the proper receptacle. Ensure the receptacle is accessible after the unit installation.

- Do not run air conditioner without side protective cover in place. This could result in mechanical damage within the air conditioner.
- Do not use an extension cord or an adapter plug.  
Avoid fire hazard or electric shock. Do not use an extension cord or an adapter plug. Do not remove any prongs from the power cord.

**For Your Safety**

Do not store or use gasoline or other flammable vapors and liquids in the vicinity of this or any other appliance.

**Prevent Accidents**

To reduce the risk of fire, electrical shock, or injury to persons when using the air conditioner, follow basic precautions, including the following:

- Ensure that the electrical service is sufficient for the selected model. This information can be found on the serial plate, which is located on the side of the the cabinet and behind the grille.
- If the air conditioner is to be installed in a window, clean both sides of the glass first. If the window is a triple-tracky pew which includes creen panel, remove the screen completely before installation.
- Be sure the air conditioner has been securely and correctly installed according to the installation instructions in this manual.

Save this manual for possible future use in removing or installing this unit.

When handling the air conditioner, be careful to avoid cuts from sharp metal fins on front and rear coils.

**Electronic Work**



**WARNING:**

BEFORE PERFORMING ANY ELECTRICAL OR WIRING WORK, TURN OFF THE MAIN POWER TO THE SYSTEM.

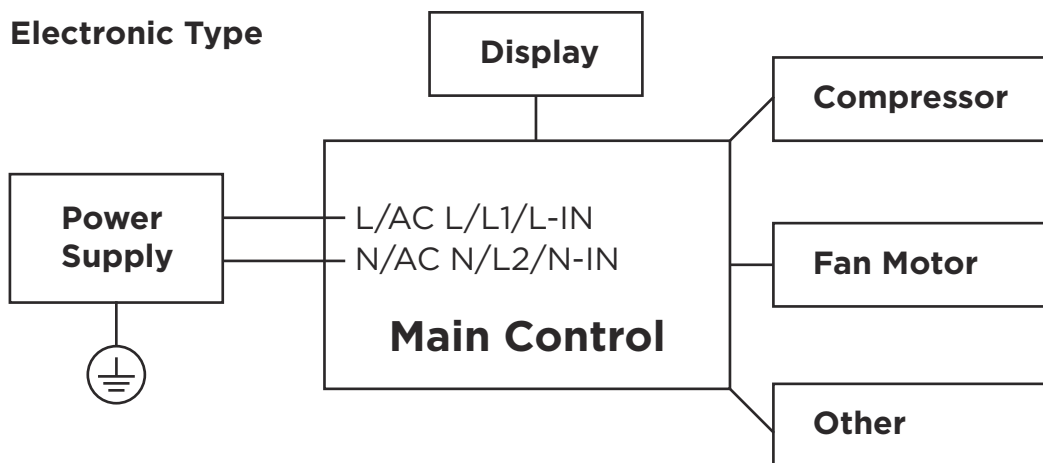

**NOTE:** Please strictly follow the wiring label attached to the machine for all wiring connections. The wiring diagram may vary for different unit. Please refer to the wiring diagram on the unit. The above wiring diagram is a simplified version for preliminary illustration purposes only.





**CAUTION:**  
**Risk of fire**  
**flammable materials**

#### Explanation of symbols displayed on the unit

	<b>CAUTION</b>	This symbol indicates that the operation manual should be read carefully.
	<b>CAUTION</b>	This symbol indicates that a service personnel should be handling this equipment with reference to the installation manual.
	<b>CAUTION</b>	This symbol indicates that information is available such as the operating manual or installation manual.

#### WARNING:

- Servicing shall only be performed as recommended by the equipment manufacturer. Maintenance and repair requiring the assistance of other skilled personnel shall be carried out under the supervision of the person competent in the use of flammable refrigerants.
- DO NOT modify the length of the power cord or use an extension cord to power the unit.
- DO NOT share a single outlet with other electrical appliances. Improper power supply can cause fire or electrical shock.
- Please follow the instruction carefully to handle, install, clear, service the unit to avoid any damage or hazard.
- When maintaining or disposing the unit, the refrigerant shall be recovered properly, shall not discharge to air directly.
- Compliance with national gas regulations shall be observed.
- Keep ventilation openings clear of obstruction.
- The unit shall be stored so as to prevent mechanical damage from occurring.
- A warning that the unit shall be stored in a well-ventilated area where the room size corresponds to the room area as specified for operation.
- Any person who is involved with working on or breaking into a refrigerant circuit should hold a current valid certificate from an industry-accredited assessment authority, which authorizes their competence to handle refrigerants safely in accordance with an industry recognised assessment specification. All training shall follow the ANNEX HH requirements of UL 60335-2-40 4th Edition.

Examples for such working procedures are:

- Breaking into the refrigerating circuit;
- Opening of sealed components;
- Opening of ventilated enclosures.

## **1. Transport of equipment containing flammable refrigerants**

See transport regulations.

## **2. Marking of equipment using signs**

See local regulations.

## **3. Disposal of equipment using flammable refrigerants**

See national regulations.

## **4. Storage of equipment**

The storage of the unit should be in accordance with the applicable regulations or instructions, whichever is more stringent.

## **5. Storage of packed (unsold) equipment**

Storage package protection should be constructed such that mechanical damage to the equipment inside the package will not cause a leak of the refrigerant charge. The maximum number of pieces of equipment permitted to be stored together will be determined by local regulations.

## **6. Information on servicing**

### 1) Checks to the area

Prior to beginning work on systems containing flammable refrigerants, safety checks are necessary to ensure that the risk of ignition is minimized. For repair to the refrigerating system, the following precautions shall be complied with prior to conducting work on the system.

### 2) Work procedure

Work shall be undertaken under a controlled procedure so as to minimize the risk of a flammable gas or vapor being present while the work is being performed.

### 3) General work area

All maintenance staff and others working in the local area shall be instructed on the nature of work being carried out. Work in confined spaces shall be avoided.

The area around the workspace shall be sectioned off. Ensure that the conditions within the area have been made safe by control of flammable material.

### 4) Checking for presence of refrigerant

The area shall be checked with an appropriate refrigerating detector prior to and during work, to ensure the technician is aware of potentially flammable atmospheres. Ensure that the leak detection equipment being used is suitable for use with flammable refrigerants. (i.e. non-sparking, adequately sealed or intrinsically safe)

### 5) Presence of fire extinguisher

If any hot work is to be conducted on the refrigeration equipment or any associated parts, appropriate fire extinguishing equipment shall be available to hand. Have a dry powder or CO<sub>2</sub> fire extinguisher adjacent to the charging area.

### 6) No ignition sources

No person carrying out work in relation to a refrigerating system which involves exposing any pipe work that contains or has contained flammable refrigerant shall use any sources of ignition in such a manner that it may lead to the risk of fire or explosion. All possible ignition sources, including smoking, should be kept sufficiently far away from the site of installation, repairing, removing and disposal, during which flammable refrigerant can possibly be released to the surrounding space. Prior to work taking place, the area around the equipment is to be surveyed to make sure that there are no flammable hazards or ignition risks. "No Smoking" signs shall be displayed.

## 7) Ventilated area

Ensure that the area is in the open or that it is adequately ventilated before breaking into the system or conducting any hot work. A degree of ventilation shall continue during the period that the work is carried out. The ventilation should safely disperse any released refrigerant and preferably expel it externally into the atmosphere.

## 8) Checks to the refrigerating equipment

Where electrical components are being changed, they shall be fit for the purpose and to the correct specifications. At all times the manufacturer's maintenance and service guidelines shall be followed. If in doubt consult the manufacturer's technical department for assistance. The following checks shall be applied to installations using flammable refrigerants: the actual refrigerant charge is in accordance with the room size within which the refrigerant containing parts are installed; the ventilation machinery and outlets are operating adequately and are not obstructed; if an indirect refrigerating circuit is being used, the secondary circuit shall be checked for the presence of refrigerant; marking to the equipment continues to be visible and legible.

Markings and signs that are illegible shall be corrected; and refrigerating pipe or components are installed in a position where they are unlikely to be exposed to any substance which may corrode refrigerant containing components, unless the components are constructed of materials which are inherently resistant to being corroded or are suitably protected against being so corroded.

## 9) Checks to electrical devices

Repair and maintenance to electrical components shall include initial safety checks and component inspection procedures. If a fault exists that could compromise safety, then no electrical supply shall be connected to the circuit until it is satisfactorily dealt with. If the fault cannot be corrected immediately but it is necessary to continue operation, an adequate temporary solution shall be used.

This shall be reported to the owner of the equipment so all parties are advised.

Initial safety checks shall include: That capacitors are discharged: this shall be done in a safe manner to avoid possibility of sparking; that there no live electrical components and wiring are exposed while charging, recovering or purging the system; that there is continuity of earth bonding.

**7. Sealed electrical components shall be replaced.**

**8. Intrinsically safe components must be replaced.**

## **9. Cabling**

Check that cabling will not be subject to wear, corrosion, excessive pressure, vibration, sharp edges or any other adverse environmental effects. The check shall also take into account the effects of aging or continual vibration from sources such as compressors or fans.

## 10. Detection of flammable refrigerants

Under no circumstances shall potential sources of ignition be used in the searching for or detection of refrigerant leaks. A halide torch (or any other detector using a naked flame) shall not be used.

The following leak detection methods are deemed acceptable for systems containing flammable refrigerants. Electronic leak detectors shall be used to detect flammable refrigerants, but the sensitivity may not be adequate, or may need re-calibration. (Detection equipment shall be calibrated in a refrigerant-free area.) Ensure that the detector is not a potential source of ignition and is suitable for the refrigerant used. Leak detection equipment shall be set at a percentage of the LFL of the refrigerant and shall be calibrated to the refrigerant employed and the appropriate percentage of gas (25 % maximum) is confirmed. Leak detection fluids are suitable for use with most refrigerants but the use of detergents containing chlorine shall be avoided as the chlorine may react with the refrigerant and corrode the copper pipe-work. If a leak is suspected, all naked flames shall be removed/ extinguished. If a leakage of refrigerant is found which requires brazing, all of the refrigerant shall be recovered from the system, or isolated (by means of shut off valves) in a part of the system remote from the leak. Removal of refrigerant shall be according to Removal and evacuation.

## 11. Removal and evacuation

When breaking into the refrigerant circuit to make repairs—or for any other purpose - conventional procedures shall be used. However, for flammable refrigerants it is important that best practice be followed, since flammability is a consideration. The following procedure shall be adhered to:

- Safely remove refrigerant following local and national regulations;
- Evacuate;
- Purge the circuit with inert gas (optional for A2L);
- Evacuate (optional for A2L);
- Continuously flush or purge with inert gas when using flame to open circuit; and
- Open the circuit.

The refrigerant charge shall be recovered into the correct recovery cylinders if venting is not allowed by local and national codes. For units containing flammable refrigerants, the system shall be purged with oxygen-free nitrogen to render the appliance safe for flammable refrigerants. This process may need to be repeated several times. Do not use compressed air or oxygen to purge refrigerant systems. For units containing flammable refrigerants, refrigerants purging shall be achieved by breaking the vacuum in the system with oxygen-free nitrogen and continuing to fill until the working pressure is achieved, then venting to atmosphere, and finally pulling down to a vacuum (optional for A2L).

This process shall be repeated until no refrigerant is within the system (optional for A2L). When the final oxygen-free nitrogen charge is used. the system shall be vented down to atmospheric pressure to enable work to take place. The outlet for the vacuum pump shall not be close to any potential ignition sources, and ventilation shall be available.

## 12. Charging procedures

In addition to conventional charging procedures, the following requirements shall be followed.

Ensure that contamination of different refrigerants does not occur when using charging equipment.

Hoses or lines shall be as short as possible to minimize the amount of refrigerant contained in them.

Cylinders shall be kept in an appropriate position according to the instructions.

Ensure that the refrigeration system is earthed prior to charging the system with refrigerant. Label the system when charging is complete (if not already). Extreme care shall be taken not to overfill the refrigeration system. Prior to recharging the system it shall be pressure tested with OFN. The system shall be leak tested on completion of charging but prior to commissioning. A follow up leak test shall be carried out prior to leaving the site.

## 13. Decommissioning

Before carrying out this procedure, it is essential that the technician is completely familiar with the equipment and all its detail. It is recommended good practice that all refrigerants are recovered safely.

Prior to the task being carried out, an oil and refrigerant sample shall be taken in case analysis is required prior to re-use of reclaimed refrigerant. It is essential that electrical power is available before the task is commenced.

- a) Become familiar with the equipment and its operation.
- b) Isolate system electrically.
- c) Before attempting the procedure ensure that: Mechanical handling equipment is available, if required, for handling refrigerant cylinders; all personal protective equipment is available and being used correctly; the recovery process is supervised at all times by a competent person; recovery equipment and cylinders conform to the appropriate standards.
- d) Pump down refrigerant system, if possible.
- e) If a vacuum is not possible, make a manifold so that refrigerant can be removed from various parts of the system.
- f) Make sure that cylinder is situated on the scales before recovery takes place.
- g) Start the recovery machine and operate in accordance with manufacturer's instructions.
- h) Do not overfill cylinders. (No more than 80 % volume liquid charge).
  - i) Do not exceed the maximum working pressure of the cylinder, even temporarily.
  - j) When the cylinders have been filled correctly and the process completed, make sure that the cylinders and the equipment are removed from site promptly and all isolation valves on the equipment are closed off.
- k) Recovered refrigerant shall not be charged into another refrigeration system unless it has been cleaned and checked.

## 14. Labeling

Equipment shall be labeled stating that it has been de-commissioned and emptied of refrigerant. The label shall be dated and signed. Ensure that there are labels on the equipment stating the equipment contains flammable refrigerant.

## **15. Recovery**

When removing refrigerant from a system, either for servicing or decommissioning, it is recommended good practice that all refrigerants are removed safely. When transferring refrigerant into cylinders, ensure that only appropriate refrigerant recovery cylinders are employed. Ensure that the correct number of cylinders for holding the total system charge is available. All cylinders to be used are designated for the recovered refrigerant and labelled for that refrigerant (i.e. special cylinders for the recovery of refrigerant). Cylinders shall be complete with pressure relief valve and associated shut-off valves in good working order. Empty recovery cylinders are evacuated and, if possible, cooled before recovery occurs. The recovery equipment shall be in good working order with a set of instructions concerning the equipment that is at hand and shall be suitable for the recovery of the flammable refrigerant. If in doubt, the manufacturer should be consulted. In addition, a set of calibrated weighing scales shall be available and in good working order. Hoses shall be complete with leak-free disconnect couplings and in good condition.

The recovered refrigerant shall be processed according to local legislation in the correct recovery cylinder, and the relevant waste transfer note arranged. Do not mix refrigerants in recovery units and especially not in cylinders. If compressors or compressor oils are to be removed, ensure that they have been evacuated to an acceptable level to make certain that flammable refrigerant does not remain within the lubricant. The compressor body shall not be heated by an open flame or other ignition sources to accelerate this process. When oil is drained from a system, it shall be carried out safely.

# WHAT IS IN THE BOX



1/2in Screws and Safety Lock(3 Types)



Top Rail



3/8in Screws

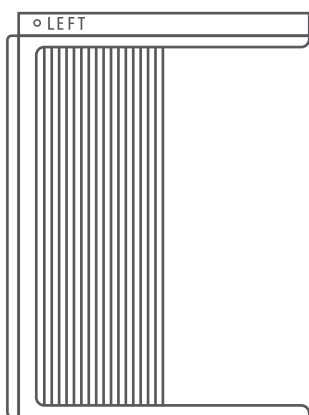

Frame Assembly(Left)

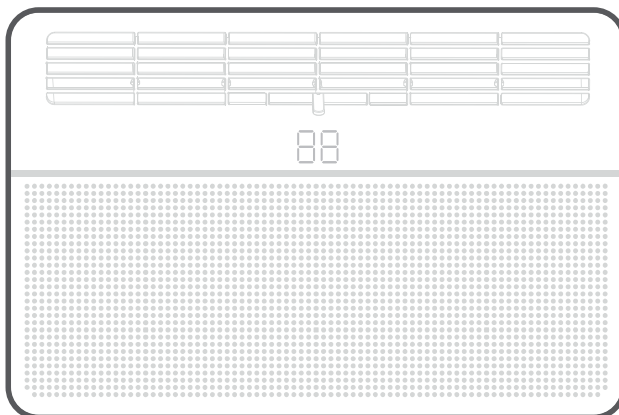

Window Type Room Air Conditioner unit

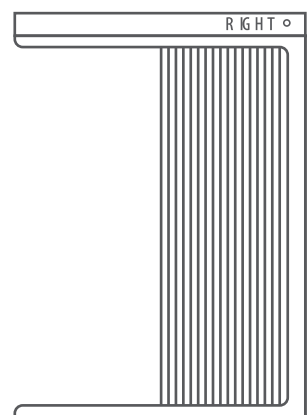

Frame Assembly(Right)

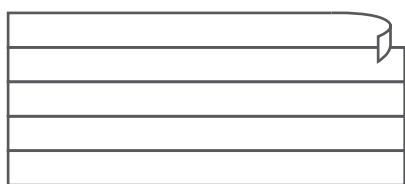

Foam insert(E-Star model only)



Window Sash Seal Foam (with glue)

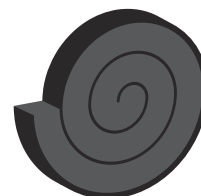

Window Sash Seal Foam (non glue)

## Prepare the following tools



Gloves



Screwdriver



Pencil



Scissors



Drill

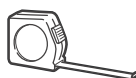

Ruler or tape measure



Level

\*Not Included

## NOTE

The purchased unit may differ in appearance; please refer to the actual materials for reference.

# BEFORE GETTING STARTED



The installation must be carried out in strict accordance with the instructions in this manual.



Installing the AC should take about 60 minutes.



Assistance from a helper is advised.



Customer Service:  
1-866-646-4332

## NOTE

Save the packaging and these Installation Instructions for future reference. The original package is the best way to store unit during winter, or when not in use.

## ! WINDOW REQUIREMENTS

The air conditioner is designed to install in standard double hung windows with opening widths of 23 to 36 inches (584mm to 914mm).

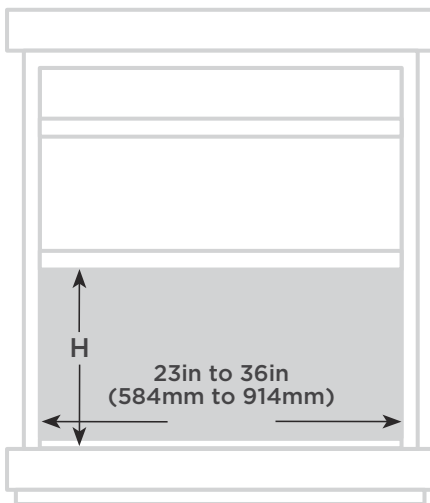

Window opening height	8000~10000Btu/h	12000~14500Btu/h
• H	14in (356mm)	15-1/2in (394mm)

## ! CAUTION

- Do not, under any circumstances, cut or remove the third (ground) prong from the power cord.
- Do not change the plug on the power cord of the air conditioner. Aluminum house wiring may present special problems - consult a qualified electrician. When handling unit, be careful to avoid cuts from sharp metal edges and aluminum fins on front and rear coils.
- The rear of the unit must be outdoors, not inside a building or garage.

# INSTALLATION OVERVIEW

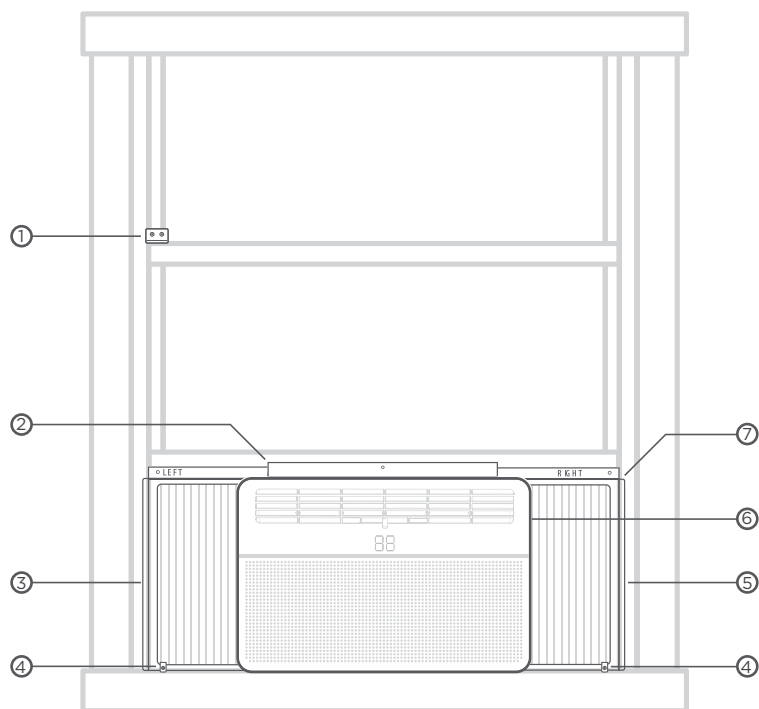

- ① Safety Lock and 1/2in Screws
- ② Top Rail and 3/8in Screws
- ③ Frame Assembly (Left)
- ④ Safety Lock and 1/2in Screw
- ⑤ Frame Assembly (Right)
- ⑥ Air Conditioner unit
- ⑦ Window Sash Seal Foam
- ⑧ Remote controller

## NOTE

Illustrations in this manual are for explanatory purposes. The actual shape of the indoor unit may be slightly different. The actual shape shall prevail.

## STEP 1 INSTALL THE AC UNIT.

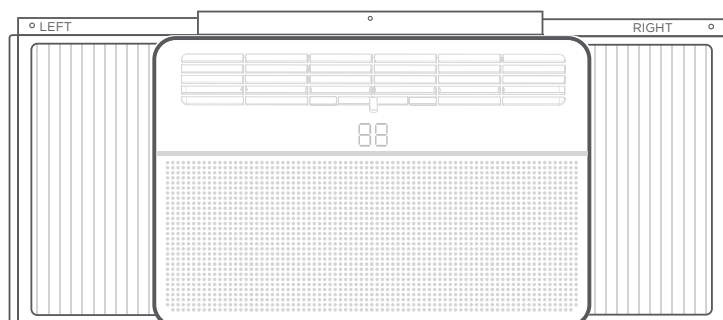

What you need.

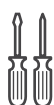

## Install the AC.

### (1) Install the top rail on the AC.

Install the Top Rail on the AC with 4 Screws (3/8in). For safety reasons, all 4 screws MUST be securely fastened.

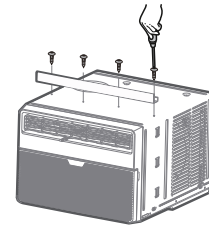

### (2) Pull the panels.

Slide the left and right panels halfway into the frame assembly.

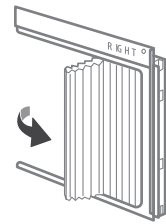

### (3) Install the frame assembly.

Insert the panel into the side slot of the AC, pay attention to the left and right differences of the panel.

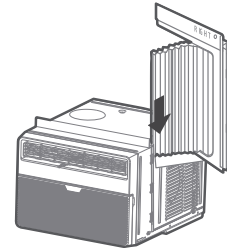

**NOTE:** Top rail and Sliding Panels at each side are offset to provide the proper pitch to the rear of (5/16 "). This is necessary for proper condensed water utilization and drainage. If the side panels are not being used, it is important to maintain this pitch toward the rear.

### (4) Fasten the panels to the AC.

Stretch the wind screen outward and insert the upper and lower frame strips of the panels into the AC card slot.

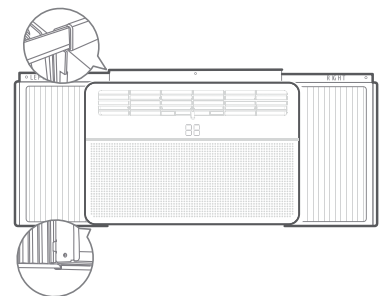

### (5) The AC unit is done.

Before the next installation phase, please confirm the following installation is in place.

- A. Insert the upper and lower frame strips of the panels into the cabinet card slot.
- B. Top Rail on the AC with 4 Screws.
- C. Insert the panel on the side of the AC.

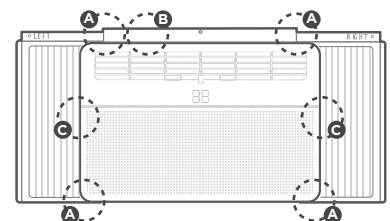

## STEP 2 INSULATE THE WINDOW.

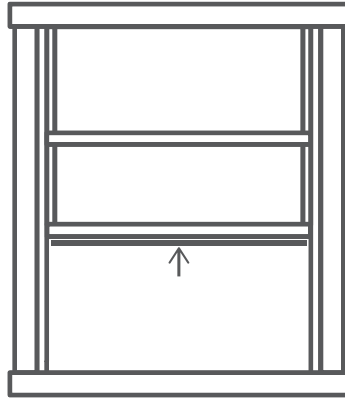

What the need.

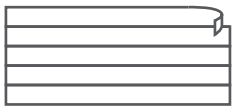

**(1) Cut the seal foam to the width of the window, and stick it of the underside.**

Cut the adhesive foam to the width of the window, then stick it of the underside of the window.

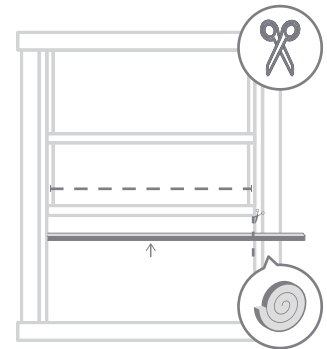

**(2) Insert the foam to the gaps on the side.**

In order to improve the operation of the unit and reduce the noise generated during operation, it is necessary to seal the gaps with foam.

- If the window already has a liner or insulation strip, skip this step.

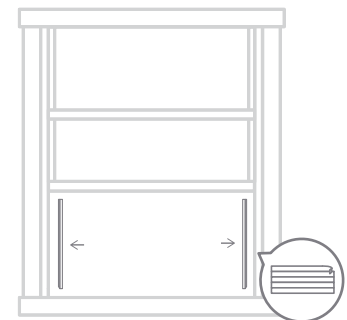

## STEP 3 LIFT THE AC INTO THE WINDOW.

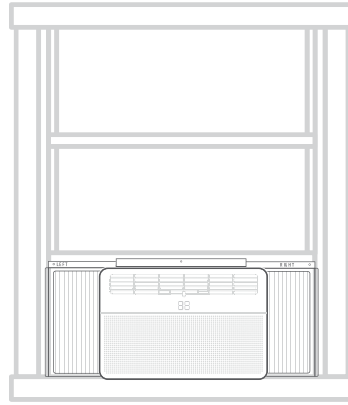

### What you need.



#### (1) With an assistant, lift the assembled AC into the window frame.

Ensure this step is completed with an assistant. Carefully lift the assembled AC into the window frame, making sure someone is securely holding the back of the unit.

- It can be helpful to rest the unit on the inside window sill until ready for proper repositioning. Improper handling may result in injury to individuals or damage to property.

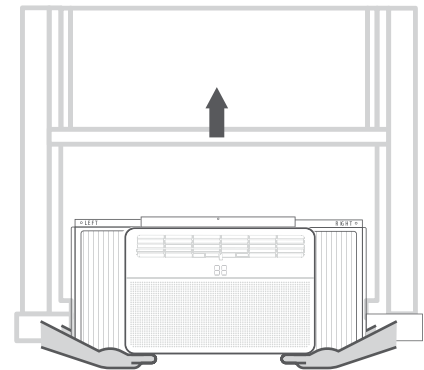

#### (2) Properly position the bottom bar BEHIND the inside window sill.

Properly position the bottom bar behind the inside window sill and insert it into the bottom horizontal channel of the window frame. The front of the bottom bar should be pressing up against the back edge of the sill.

- Verify that the air conditioner is tilted back approximately  $3^{\circ}$  to  $4^{\circ}$  toward the outside. After proper installation, condensate should not drain from the overflow drain hole during normal use. If it does, adjust the slope accordingly.

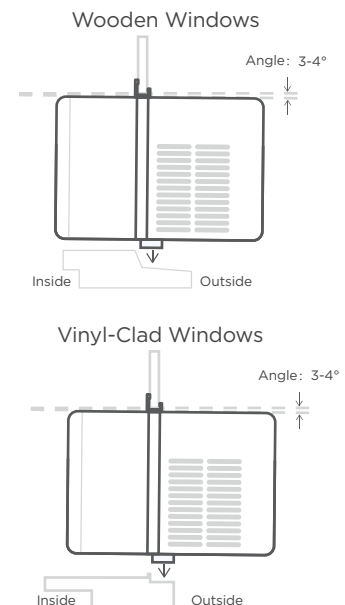

## Lift the AC into the window.

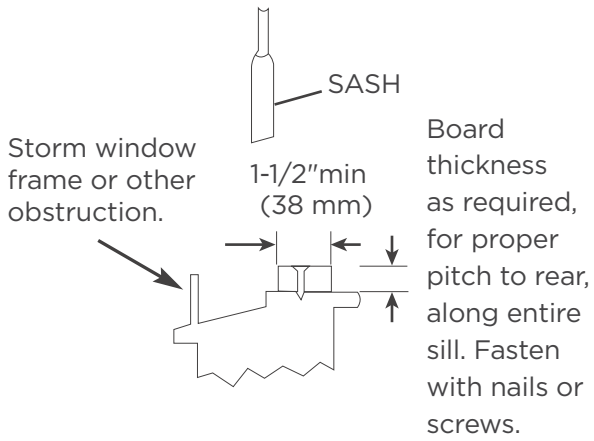

### CAUTION

If storm window blocks AC, Please install according to the figure above.

### (3) Close the window onto the AC, and pull the panels to the side of the window.

Once the AC is centered and the bottom bar is successfully positioned, close the window down onto the AC, behind the top bar. See diagram above. Pull the panels to the side of the window.

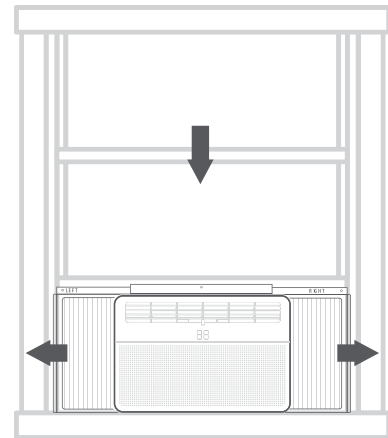

## STEP 4 SECURE THE AC.

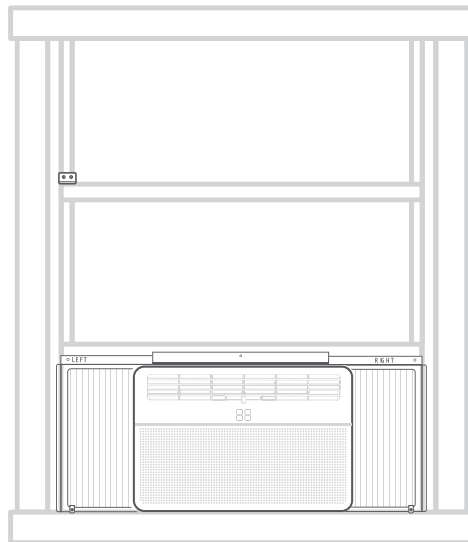

## What you need.

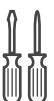

## Secure the AC.

### (1) Drive locking screws.

Follow the above instructions and drive the screws.

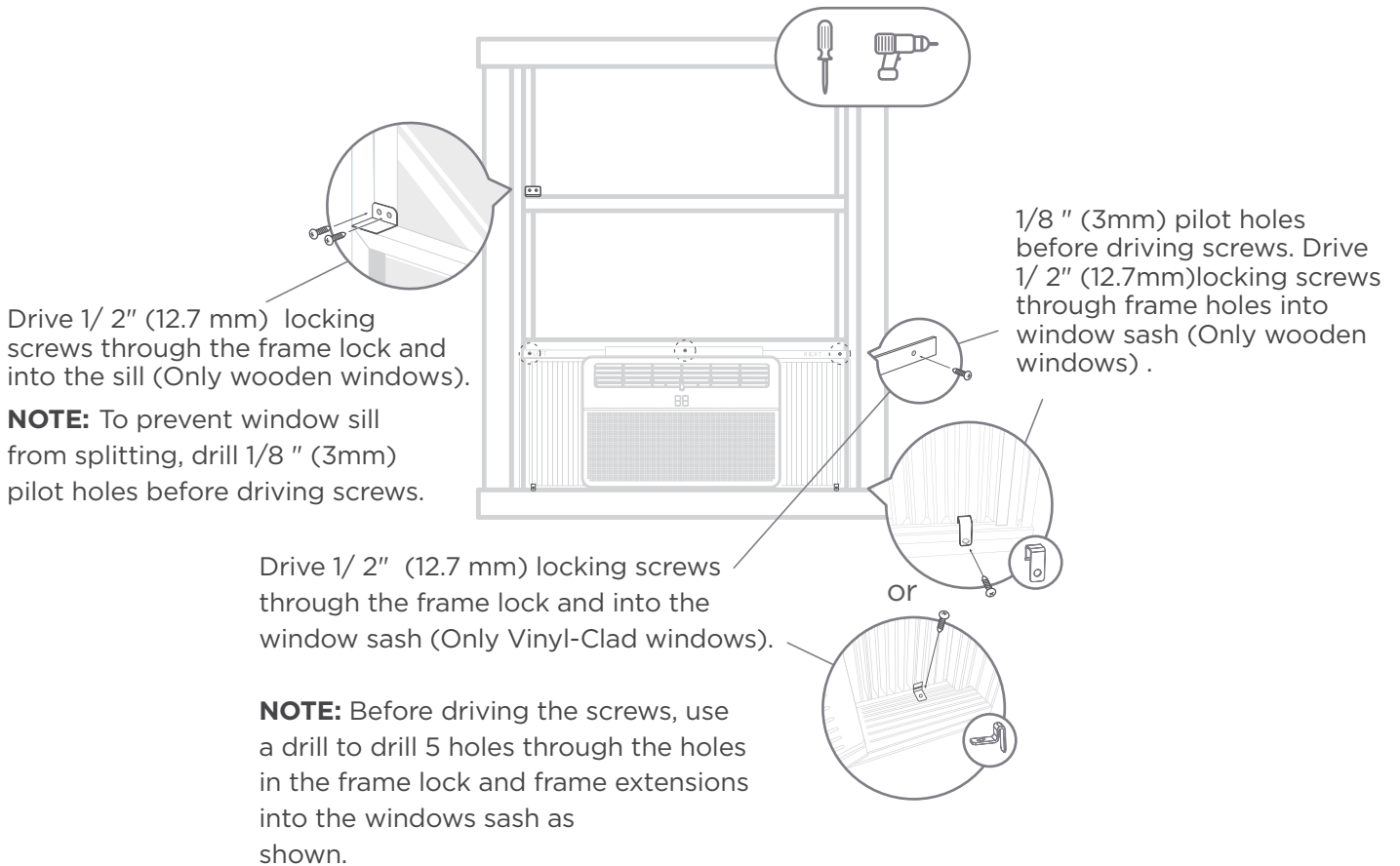

### (2) Cut the non-adhesive insulation foam to fit the width of the window.

Ensure that the foam is cut from the non-adhesive sides. Measure and cut the foam to match the width of the window from the left to the right side.

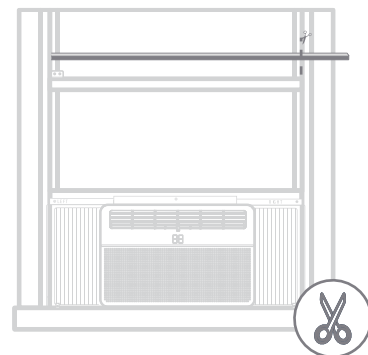

### (3) Use the non-adhesive foam to fill the gaps in the window.

Stuff it between the gap of the upper and lower sashes of the window.

**This will plug any air gaps and help keep out bugs and draft.**

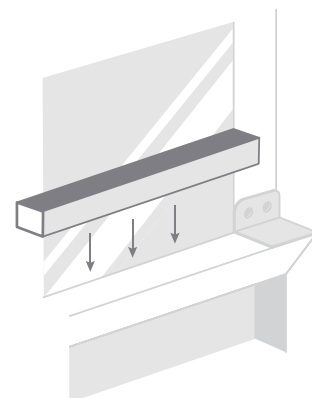

## ADDITIONAL NOTES

### 1 If AC is Blocked by Storm Window.

Add wood as shown in Caution illustration on page 16, or remove storm window before air conditioner is installed. If storm window frame must remain, be sure the drain holes or slots are not caulked or painted shut. Accumulated rain water or condensation must be allowed to drain out.

#### Removing AC From Window

Turn AC off, and disconnect power cord. Remove sash seal from between windows, and unscrew safety sash lock. Remove screws installed through frame and frame-lock. Keep a firm grip on air conditioner, raise sash and carefully remove. Be carefully not to spill any remaining water while lifting unit from window. Store parts with air conditioner.

### 2 Normal Sounds

#### High Pitched Chatter

High efficiency compressors may have a high pitched chatter during the cooling cycle.

#### Sound of Rushing Air

At the front of the unit, the sound of rushing air from the fan may be audible.

#### Gurgle/Hiss

“Gurgling or hissing” noise may be heard due to refrigerant passing through evaporator during normal operation.

#### Vibration

Unit may vibrate and make noise because of poor wall or window construction or incorrect installation.

#### Pinging or Switching

Droplets of water hitting condenser during normal operation may cause “pinging or swishing” sounds. This noise can be reduced by removing the water plug at the bottom of unit’s rear as shown below. Removing this plug will lower the energy efficiency of the unit.

Note: Don’t try to drill any holes on the base pan to eliminate the normal sounds, otherwise it will void the warranty.

#### Noise when unit is working

In mute mode, the compressor may become more audible for about 3 minutes, which is normal. A “da-da” sound may occur for thirty seconds upon startup as the compressor activates, and this is also normal.

# GET TO KNOW THE AC

## NOTE

The actual functions of the unit may differ to the example shown here.

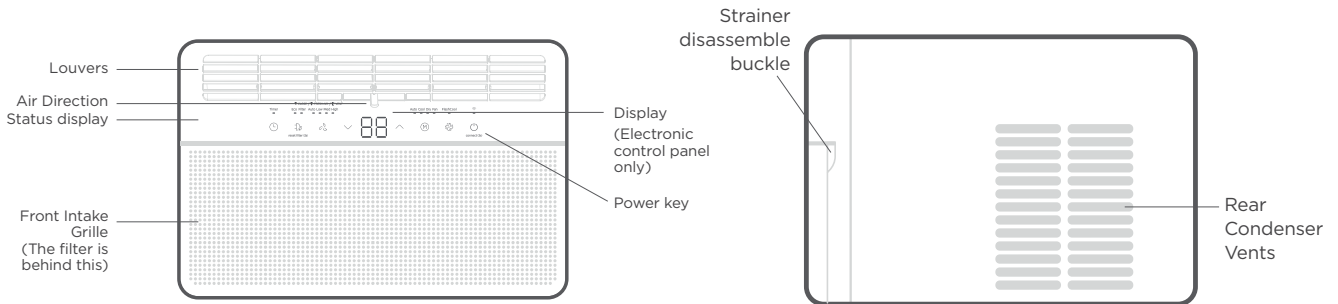

## Adjust the air conditioning direction.

### Air conditioning louvers

## CAUTION

Do not stick fingers in the air outlet, it may cause injury.

### Four-way adjustment (up or down, left or right) - For 06K/08K/10K/12K/14K

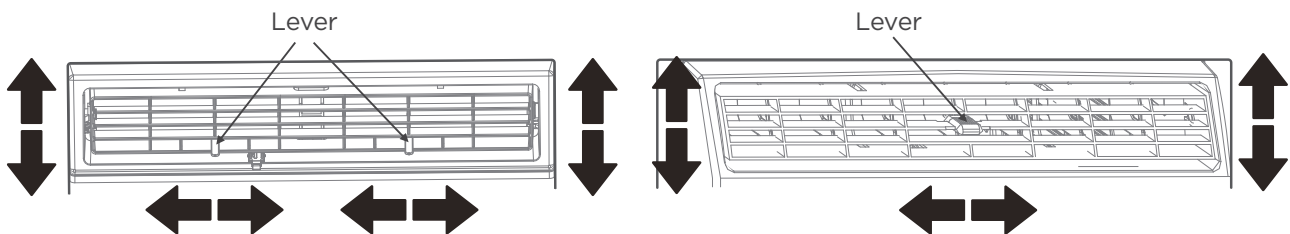

The louvers will direct the air flow Up or Down (on some models) and Left or Right throughout the room as needed. Pivot horizontal louvers until the desired Up/Down direction is obtained. Move the Lever(s) from side to side until the desired Left/Right direction is obtained.

### Fresh air vent control - For 12/14K

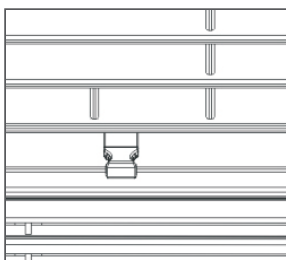

**Fig.A (CLOSE)**

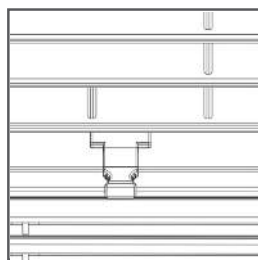

**Fig.B (FRESH AIR)**

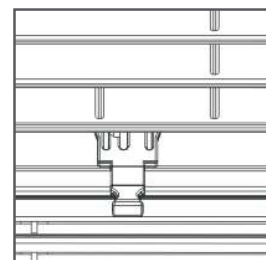

**Fig.C (VENT)**

The fresh air vent allows the air conditioner to:

1. Recirculate inside room - Fresh (See Fig.A)
2. Draw fresh air into the room - Fresh air (see Fig.B)
3. Exhaust air from the room - Vent (see Fig.C)

# GET TO KNOW THE FEATURES

## ⚠ WARNING

- To reduce the risk of fire, electric shock, or injury to persons, read the **IMPORTANT SAFETY INSTRUCTIONS** before operating this unit.
- Please always wait 3 minutes when turning unit off then on again, and when changing from cool to fan and back to cool. This prevents compressor from overheating & possible circuit breaker tripping.

## Electronic control operating instructions

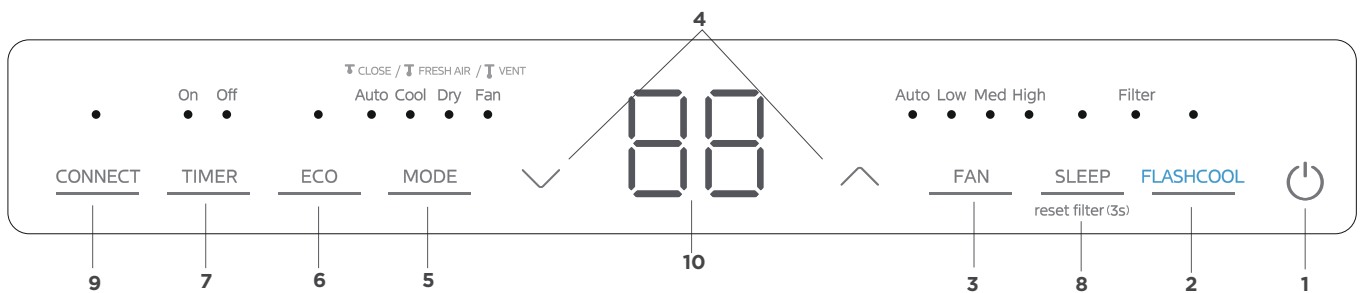

### 1. TO TURN UNIT ON OR OFF:

Press POWER button to turn unit on or off.

### 2. FLASHCOOL FUNCTION:

Press this button to initiate the FlashCool function. FlashCool provides maximum cooling and sets the fan to the highest speed. The unit will operate in this mode until change mode, adjust fan speed or the function is turned off. The unit will then return to normal cooling operation with the fan speed set to high.

NOTE: If you use remote to enter in flashcool, you have to set cool mode first of the remote.

### 3. TO ADJUST FAN SPEEDS:

Press Fan button to select the Fan Speed in four steps-Auto, Low, Med or High. Each time the button is pressed, the fan speed mode is shifted. For some models, the fan speed can't be adjusted.

### 4. TO CHANGE TEMPERATURE SETTING:

Press UP/DOWN button to change temperature setting.

**NOTE:** Press or hold either UP or DOWN button until the desired temperature is shown on the display. This temperature will be automatically maintained anywhere between 60°F (16°C) and 86°F (30°C). If you want the display to read the actual room temperature, see "To Operate on Fan Only" section.

### 5. TO SELECT THE OPERATING MODE:

To choose operating mode, press Mode button. Each time you press the button, a mode is selected in a sequence that goes from Auto, Cool, Dry, heat (cooling only models without) and Fan. The indicator light beside will be illuminated and remained on once the mode is selected. The unit will initiate automatically the Energy Saver function under Cool, Dry, Auto (only Auto-Cooling and Auto-Fan) modes.

### **To operate on COOL mode :**

- Choose Cool Mode to set the cooling function. Use the Up and Down buttons to choose the desired temperature. When Cool Mode is selected, the fan speed can be adjusted by pressing the fan button.

### **To operate on HEAT mode (cooling only models without) :**

- Choose Heat Mode to set the heating function. Use the Up and Down buttons to choose the desired temperature .When heat Mode is selected, the fan speed can be adjusted by pressing the fan button.

**NOTE:** For some models, the fan speed can not be adjusted under HEAT mode.

### **To operate on Auto feature:**

- When you set the air conditioner in AUTO mode, it will automatically select cooling, heating (cooling only models without) , or fan only operation depending on what temperature you have selected and the room temperature.
- The air conditioner will control room temperature automatically round the temperature point set by you.
- In this mode, the fan speed cannot be adjusted, it starts automatically at a speed according to the room temperature.

### **To operate in Fan Only**

- Use this function only when cooling is not desired, such as for room air circulation or to exhaust stale air (on some models) . (Remember to open the vent during this function, but keep it close during cooling for maximum cooling efficiency. )

You can choose any fan speed you prefer.

- During this function, the display will show the actual room temperature, not the set temperature as in the cooling mode.

- In Fan only mode, the temperature is not adjusted.

### **To operate on Dry mode:**

- In this mode, the air conditioner will generally operate in the form of a dehumidifier. Since the conditioned space is a closed or sealed area, some degree of cooling will continue. On Dry mode,the fan speed is controlled at Auto automatically.

## **6. ENERGY SAVER FEATURE:**

Press Energy saver button to initiate this function. This function is available on COOL, DRY, AUTO (only AUTO-COOLING and AUTO-FAN) modes. The fan will continue to run for 3 minutes after the compressor shuts off.The fan then cycles on for 2 minutes at 10 minute intervals until the room temperature is above the set temperature, at which time the compressor turns back on and Cooling Starts.

## **7. TIMER: AUTO START/STOP FEATURE:**

- Press Timer button, the TIMER ON or TIMER OFF indicator light illuminates. It indicates the Auto Start or Auto Stop program is initiated. For some units, keep pressing the Timer button will cancel the timer settings.
- Press or hold the UP or DOWN button to change the Auto time by 0.5 hour increments, up to 10 hours, then at 1 hour increments up to 24 hours. The control will count down the time remaining until start.
- The selected time will register in 5 seconds, and the system will automatically revert back to display the previous temperature setting or room temperature when the unit is on. (when the unit is off,there is no display).
- Turning the unit ON or OFF at any time or a djusting the timer setting to 0.0 will cancel the Auto Start/Stop timed program.

## **8. SLEEP FEATURE:**

Press Sleep button to initiate the sleep mode. In this mode the selected temperature will increase (cooling) or decrease (heating) by 2°F/1°C 30 minutes after the mode is selected.

The temperature will then increase (cooling) or decrease (heating) by another 2°F/1°C after an additional 30 minutes. This new temperature will be maintained for 6 or 7 hours before it returns to theoriginally selected temperature.

This ends the Sleep mode and the unit will continue to operate as originally programmed. The Sleep mode program can be cancelled at any time during operation by pressing the Sleep button again.

Press and hold on the SLEEP button for 3 seconds to initiate the reset filter connection mode.

This feature is a reminder to clean the Air Filter for more efficient operation. The LED (light) will illuminate after 250 hours of operation. To reset after cleaning the filter, press the SLEEP button and the light will go off.

## 9. Wireless button

Press and hold on the POWER button for 3 seconds to initiate the Wireless connection mode.

## 10. DISPLAYS:

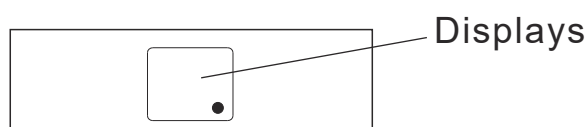

Shows the set temperature in " °C" or " °F" and the Auto-timer settings. While on Fan only mode, it shows the room temperature.

If the room temperature is too high or low, it will display " HI" or " LO".

Error codes:

The unit may stop operation or continue to run safely. If the error codes appear, wait for about 10 minutes. The problem may resolve itself. If not, disconnect the power, then connect it again. Turn the unit on.

If the problem persists, disconnect the power and contact your nearest customer service center.

Error code appears and begins with the letters as the following in the window display of indoor unit:

EH ( xx ) , EL ( xx ) , EC ( xx ) , PH ( xx ) , PL ( xx ) , PC ( xx ) , HI.

NOTE: If your problem persists after performing the checks and diagnostics above, turn off your unit immediately and contact an authorized service center.

NOTE: When the unit is operating under high temperature, the fan speed may be increased to ensure that the machine can operate normally. At extreme high temperature, the fan speed is forced to the maximum fan speed, if you want to adjust the fan speed, 'HI' may display for 3 seconds for some units.

### NOTICE

If the unit breaks off unexpectedly due to the power cut, it will restart with the previous function setting automatically when the power resumes.

## ADDITIONAL THINGS YOU SHOULD KNOW

Now that you have mastered the operating procedure, here are more features in your control that you should become familiar with.

- The Cool circuit has an automatic 3 minutes time delayed start if the unit is turned off and on quickly. This prevents overheating of the compressor and possible circuit breaker tripping. The fan will continue to run during this time.
- The control is capable of displaying temperature in degrees Fahrenheit or degrees Celsius. To convert from one to the other, press and hold the Up and Down buttons at the same time for 3 seconds.

# CLEANING & MAINTENANCE

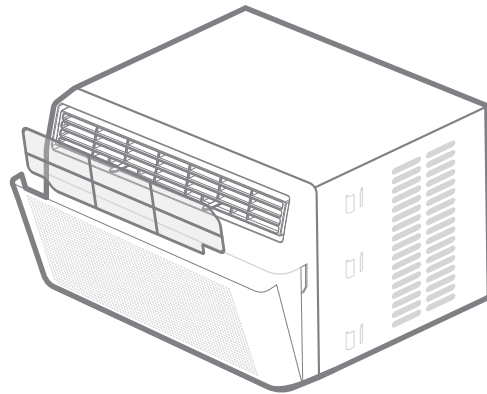

## Check the air filter once a month to see if cleaning is necessary.

The air filter should be checked at least once a month to see if cleaning is necessary. Trapped particles in the filter can build up and cause an accumulation of frost on the cooling coils.

- Push the vent handle to the Vent Closed position (where applicable). Open the front panel.
- Take the filter by the center and pull up and out.
- Wash the filter using liquid dishwashing detergent and warm water. Rinse filter thoroughly. Gently shake excess water from the filter. Be sure the filter is thoroughly dry before replacing. Filter can be cleaned with a vacuum rather than washing.

**Note:** Never use hot water over 40°C ( 104°F ) to clean the air filter. Never attempt to operate the unit without the air filter.

## Cabinet Cleaning

- Be sure to unplug the air conditioner to prevent shock or fire hazard. The cabinet and front may be dusted with an oil-free cloth or washed with a cloth dampened in a solution of warm water and mild liquid dishwashing detergent. Rinse thoroughly and wipe dry.
- Never use harsh cleaners, wax or polish on the cabinet front.
- Be sure to wring excess water from the cloth before wiping around the controls. Excess water in or around the controls may cause damage to the air conditioner.
- Plug in air conditioner.



**CAUTION:** Clean the air conditioner occasionally to keep it looking new. **Be sure to unplug the unit before cleaning to prevent shock or fire hazards.**



**CAUTION:** If the air conditioner is to be stored during the winter, carefully uninstall the unit from the window according to the installation instructions. Store the unit in the original carton or cover it with plastic.

# TROUBLESHOOTING TIPS

Before scheduling a service call, please consult the chart below. It is designed to help identify common issues that are not attributable to defects in workmanship or materials. Reviewing this chart may assist in resolving problems more efficiently and cost-effectively.

Problem	Solution
<b>Air conditioner does not start.</b>	Wall plug disconnected. Push plug firmly into wall outlet.
	House fuse blown or circuit breaker tripped. Replace fuse with time delay type or reset circuit breaker.
	Plug Current Device Tripped. Press the RESET button.
	Power is OFF. Turn power ON.
<b>Air from unit does not feel cold enough.</b>	Room temperature below 60°F (16°C). Cooling may not occur until room temperature rises above 60°F (16°C).
	Temperature sensor behind the air filter element is touching the cold coil.
	Set to a Lower temperature.
	Compressor stopped when changing modes. Wait for 3 minutes after setting to the COOL mode.
<b>Air conditioner cooling, but room is too warm - ice forming on cooling coil behind decorative front.</b>	Outdoor temperature below 64°F (18°C). To defrost the coil, set FAN ONLY mode.
	Air filter may be dirty. Clean filter. Refer to Cleaning and Maintenance section. To defrost, set to FAN ONLY mode.
	Thermostat set too cold for night-time cooling. To defrost the coil, set to FAN ONLY mode. Then, set temperature to a Higher setting.
<b>Air conditioner cooling, but room is too warm - NO ice forming on cooling coil behind decorative front.</b>	Dirty or restricted air filter. Clean air filter. Refer to Cleaning and Maintenance section.
	Temperature is set too High, set temperature to a Lower setting.
	Air directional louvers positioned improperly. Position louvers for better air distribution.
	Front of units is blocked by drapes, blinds, furniture, etc. - restricts air distribution. Clear blockage in front of unit.
	An open doors, windows, or registers may allow cold air to escape. Close any doors, windows or registers.
	The room may be too warm. Allow additional time to remove "Stored heat" from walls, ceiling, floor and furniture.
<b>Air conditioner turns on and off rapidly</b>	Dirty or restricted air filter. Clean air filter.
	Outside temperature extremely hot. Set FAN speed to a Higher setting to bring air past cooling coils more frequently.
<b>Noise when unit is cooling</b>	Air movement sound. This is normal. If too loud, set to a slower FAN setting.
	Window vibration - poor installation. Refer to installation instructions or check with installer.
	For better cooling effect, the wind wheel outside the window machine will make a splash. The rear side drain plug can be removed if the sound is not desired. (Standard installation angle of window machine 3°-5° degrees)

<b>Problem</b>	<b>Solution</b>
<b>Noise when unit is working</b>	When the mute mode is used to start the unit, due to the compressor being hot, the sound of the compressor may be more prominent. Lasting for about 3 minutes is normal. A "da-da" sound may occur for thirty seconds when the unit is turned on due to the compressor starting. It is normal.
<b>Water dripping INSIDE when unit is cooling.</b>	Improper installation. Tilt air conditioner slightly to the outside to allow water drainage. Refer to installation instructions - check with installer.
<b>Water dripping OUTSIDE when unit is cooling.</b>	Unit is removing large quantity of moisture from humid room. This is normal during excessively humid days.
<b>Remote Sensing Deactivating Prematurely (Only remote models)</b>	Remote control not located within range. Place remote control within 20 feet and pointed in the general direction of the air conditioner unit.  Remote control signal obstructed. Remove obstruction.
<b>Room too cold</b>	Set temperature too low. Increase setting temperature.

The design and specifications are subject to change without prior notice for product improvement. Any updates to the manual will be uploaded to the Midea website ([www.midea.com/us](http://www.midea.com/us)), please check for the current version.

# REMOTE CONTROL

## Handling the Remote Control

### Location of the remote control

Use the remote control within a distance of 26 ft. (8m) from the air conditioner, pointing it towards the unit. The unit will beep when it receives a signal.

#### CAUTION

- The air conditioner will not operate if curtains, doors or other materials block the signals from the remote control to the unit.
- Prevent any liquid from spilling onto the remote control. Do not expose the remote control to direct sunlight or heat.
- If the infrared signal receiver on the indoor unit is exposed to direct sunlight, the air conditioner may not function properly. Use curtains to prevent the sunlight from falling on the receiver.
- If other electrical appliances react to the remote control, either move these appliances or consult the local dealer.

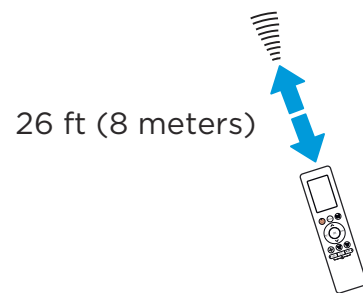
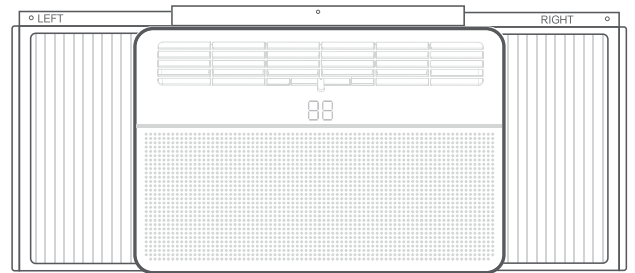

## Inserting and Replacing Batteries

The air conditioning unit may come with two batteries (some units). Put the batteries in the remote control before use.

1. Slide the back cover from the remote control downward, exposing the battery compartment.
2. Insert the batteries, paying attention to match up the (+) and (-) ends of the batteries with the symbols inside the battery compartment.
3. Slide the battery cover back into place.

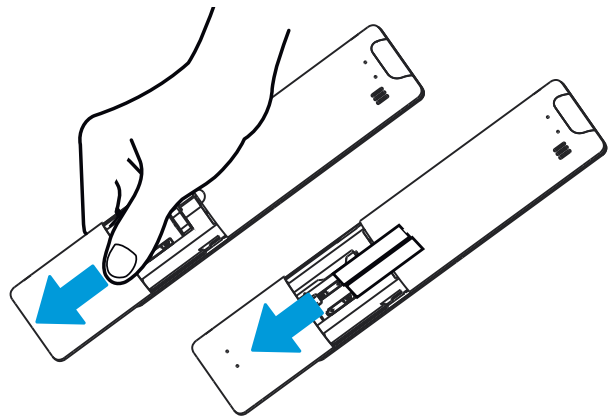



## Remote Control Specifications

Rated Voltage	3.0V (Dry batteries R03/LR03x2)
Signal Receiving Range	26 ft (8 m)
Environment	-5 °C ~ 60 °C (23°F ~ 140°F)

## Function Buttons

**ON/OFF**  
Turns the unit on or off.

**TEMP ^**  
Increases temperature in 1°C increments.  
Max. temperature is 86°F (30°C).

**SET**  
Scrolls through operation functions as follows:  
ComfortSense (  ) → AP mode (  )  
The selected symbol will flash on the display area, press the OK button to confirm.

**TEMP v**  
Decreases temperature in 1°C increments.  
Min. temperature is 60°F (16°C).

**FAN SPEED**  
Selects fan speeds in the following order:  
**AUTO → LOW → MED → HIGH**  
\*Press for 3 seconds to activate Silence Mode.  
(  )

**TIMER ON**  
Sets timer to turn unit on  
(see page 31-32 for instructions)

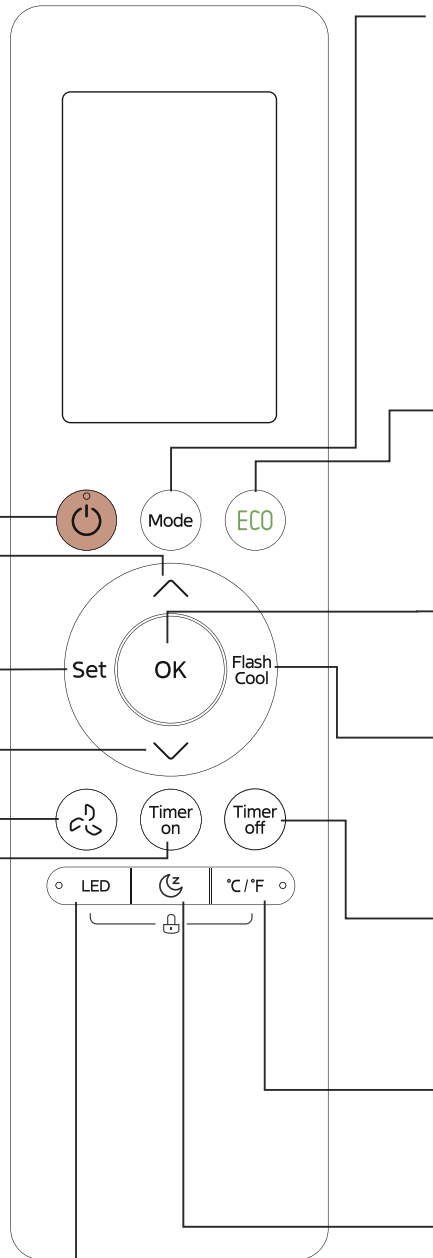

**MODE**  
Scrolls through operation modes as follows: **AUTO → COOL → DRY → HEAT → FAN**  
NOTE: Please do not select HEAT mode if the machine you purchased is cooling only type.  
Heat mode is not supported by the cooling only appliance.

**ECO**  
Press this button to activate the Energy saving mode. Press it again to stop the function.

**OK**  
Used to confirm the selected functions

**FlashCool**  
Enables unit to reach preset temperature in shortest possible time.

**TIMER OFF**  
Sets timer to turn unit off  
(see page 32-33 for instructions)

**°C/°F**  
The temperature display between the °C & °F.

**SLEEP**  
Saves energy during sleeping hours.

**LED**  
Turn the unit's LED display and control panel beeping on and off.

## Remote Screen Indicators

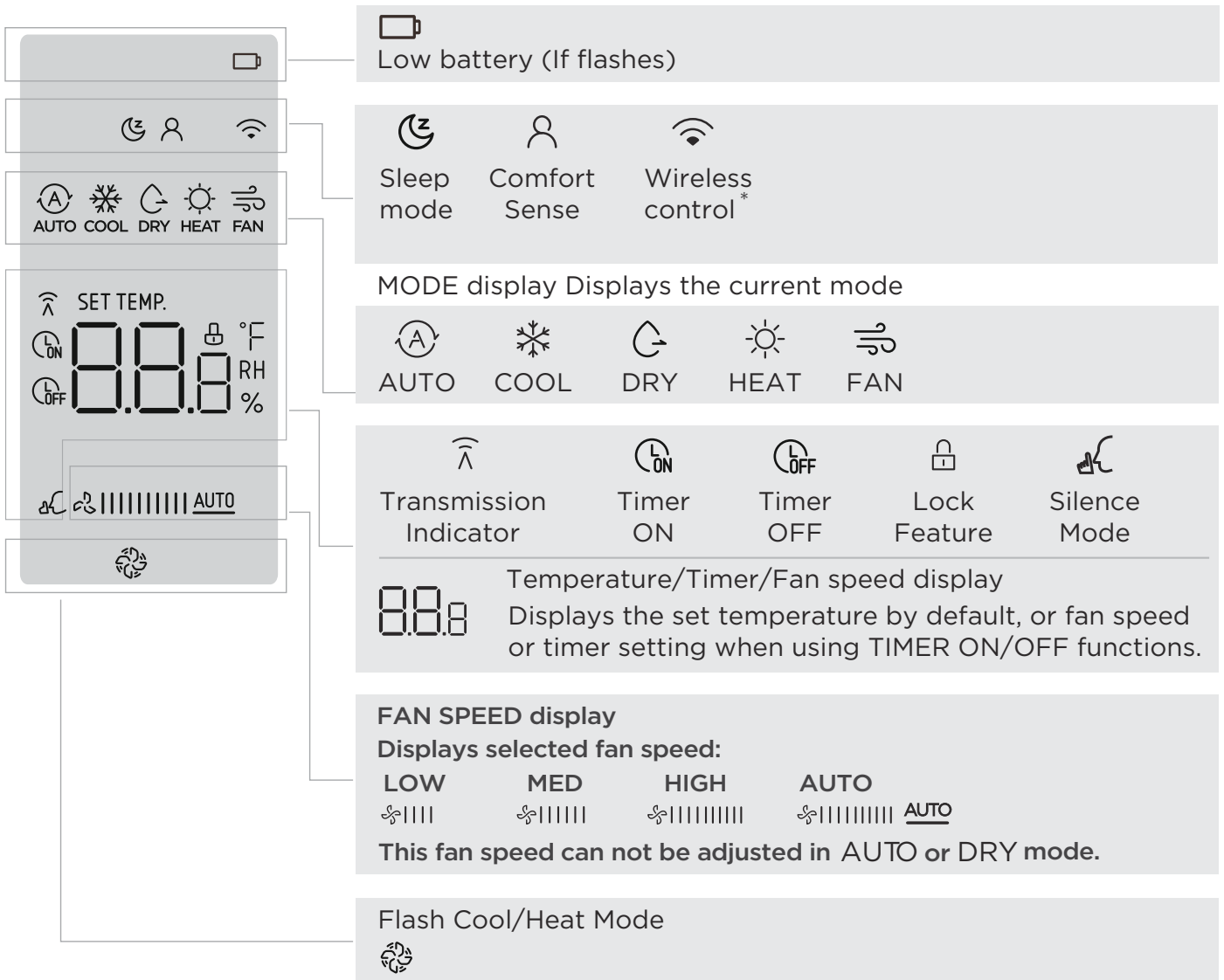

### Note:

All indicators shown above are for information purposes. During the actual operation, only the relevant indicators will be shown on the display.

### Supplier's Declaration of Conformity 47 CFR § 2.1077 Compliance Information

**Unique Identifier:** RG10G5(B2)/BGCEFU1

#### Responsible Party U.S. Contact Information

Midea America Corporation  
300 Kimball Dr  
Parsippany NJ  
07054

Telephone number or internet contact information: Midea.com/us

#### FCC Compliance Statement ( products subject to Part 15)

This device complies with Part 15 of the FCC Rules. Operation is subject to the following two conditions: (1) This device may not cause harmful interference, and (2) this device must accept any interference received, including interference that may cause undesired operation.

## Setting the TIMER

### TIMER ON/OFF

Set the amount of time after which the unit will automatically turn on/off.

#### TIMER ON SETTING

Press TIMER ON button to initiate the ON time sequence.

Press up or down button to set the desired time to turn on the unit.

Point remote to unit and wait 1 second the TIMER ON will be activated.

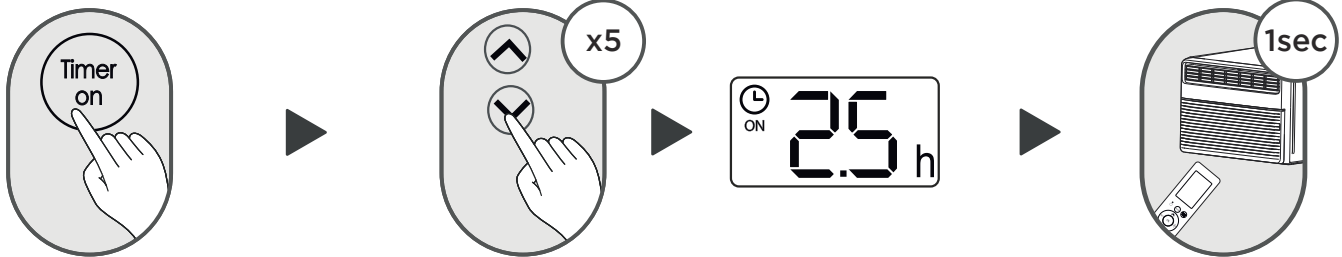

#### TIMER OFF SETTING

Press TIMER OFF button to initiate the OFF time sequence.

Press up or down button to set the desired time to turn on the unit.

Point remote to unit and wait 1 second the TIMER OFF will be activated.

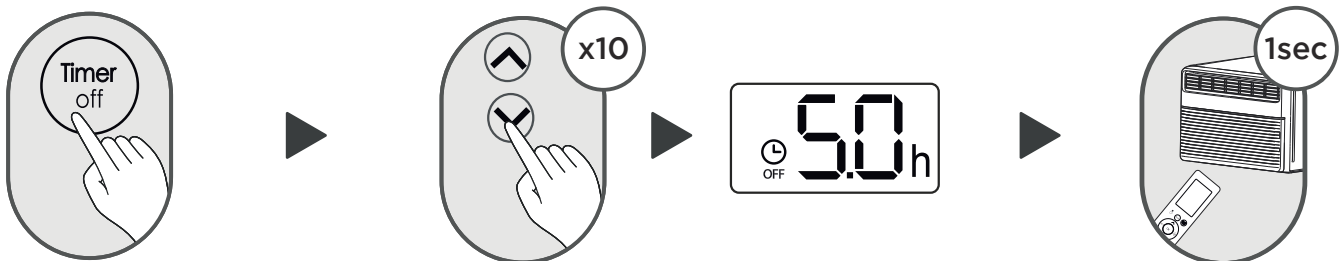

#### NOTE

1. When setting the TIMER ON or TIMER OFF, the time will increase by 30 minute increments with each press, up to 10 hours. After 10 hours and up to 24, it will increase in 1 hour increments. (i.e. press 5 times to get 2.5h, and press 10 times to get 5h,). The timer will revert to 0.0 after 24.
2. Cancel either function by setting its timer to 0.0h.

## TIMER ON & OFF SETTING (example)

Keep in mind that the time periods set for both functions refer to hours after the current time.

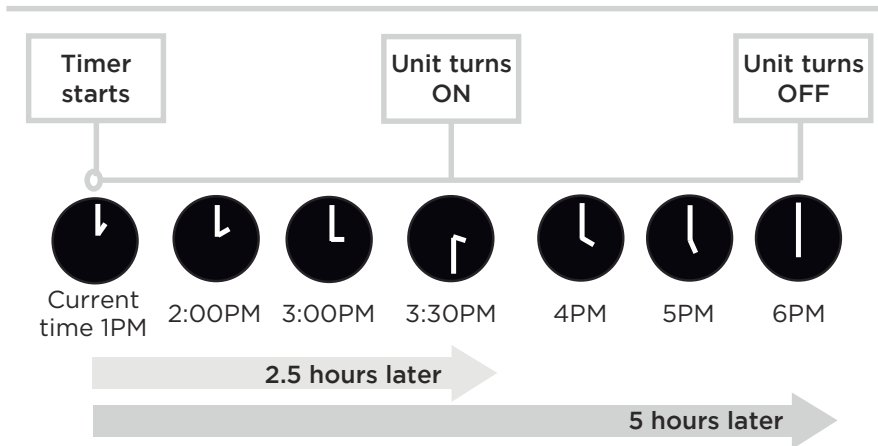
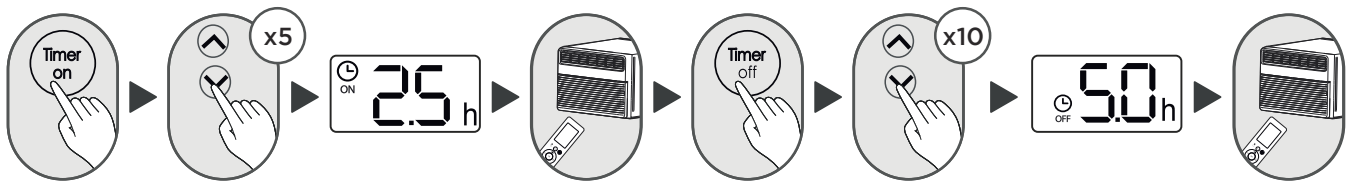

Example: If current time is 1:00PM, to set the timer as above steps, the unit will turn on 2.5h later (3:30PM) and turn off at 6:00PM.

## Declaration of Conformity

We hereby declare that this AC is in compliance with the essential requirements and other relevant provisions of Directive 1999/5/EC.

## NOTES FOR USING REMOTE CONTROL

The device could comply with the local national regulations.

- In USA, this device complies with part 15 of the FCC Rules. Operation is subject to the following two conditions:
  - (1) This device may not cause harmful interference;
  - (2) this device must accept any interference received, including interference that may cause undesired operation.

This equipment has been tested and found to comply with the limits for a Class B digital device, pursuant to part 15 of the FCC Rules. These limits are designed to provide reasonable protection against harmful interference in a residential installation. This equipment generates, uses and can radiate radio frequency energy and, if not installed and used in accordance with the instructions, may cause harmful interference to radio communications. However, there is no guarantee that interference will not occur in a particular installation. If this equipment does cause harmful interference to radio or television reception, which can be determined by turning the equipment off and on, the user is encouraged to try to correct the interference by one or more of the following measures:

- Reorient or relocate the receiving antenna.
- Increase the separation between the equipment and receiver.
- Connect the equipment into an outlet on a circuit different from that to which the receiver is connected.
- Consult the dealer or an experienced radio/TV technician for help.
- Changes or modifications not approved by the party responsible for compliance could void user's authority to operate the equipment.

# APP INSTRUCTIONS

## Specification of Wireless Module

<b>Model:</b> MAW08S1VWWT-T, MAW10S1VWWT-T, MAW12S1VWWT-T, MAW14S1VWWT-T	<b>Operation Temperature:</b> 0°C ~ 45°C / 32°F ~ 113°F
<b>Wireless Module Model:</b> US-SK109	<b>Operation Humidity:</b> 10% ~ 85%
<b>Antenna Type:</b> Printed PCB Antenna	<b>Power Input:</b> DC 5V / 500 mA
<b>Frequency Band:</b> 2400 - 2483.5MHz	<b>Maximum TX Power:</b> < 20dBm

## Precautions

1. Supports operating systems: iOS 10+ or Android 5+.
2. In the event of an OS update, there may be a delay between the OS update and a related software update, during which your OS may or may not be supported until a new version is released. Specific mobile devices or network issues may prevent the system from functioning properly, and Midea will not be responsible for any problems arising from incompatibility or network-related issues.
3. This Smart AC only supports WPA-PSK/WPA2-PSK (recommended) encryption.
4. To ensure proper scanning of the QR code, the smartphone must have a camera with at least 5 megapixels.
5. Due to unstable network connectivity, requests may time out. If this happens, re-run the network configuration.
6. Due to unstable network connectivity, commands may time out. If this happens, the smartphone app and the actual product may display conflicting information. The information displayed on the actual product is always the most accurate available. Refresh the app to re-sync.

### NOTE

Midea will not be responsible for any problems that could be caused by incompatibility or network issues, wireless router and mobile phone.

# 1. How to Use SmartHome App



Ensure that the mobile phone is connected to the wireless network. Bluetooth must be turned on. The device must also be powered up.

## STEP 1: Download the SmartHome App

Scan the QR code below to download the SmartHome app from the app store or search for it directly on the Google Play Store or Apple's App Store.

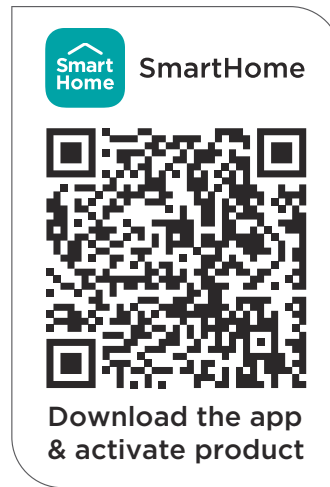

## STEP 2: Log in

Open the SmartHome app and log in with an existing account or create a new one. Alternatively, a third-party login platform can also be used.

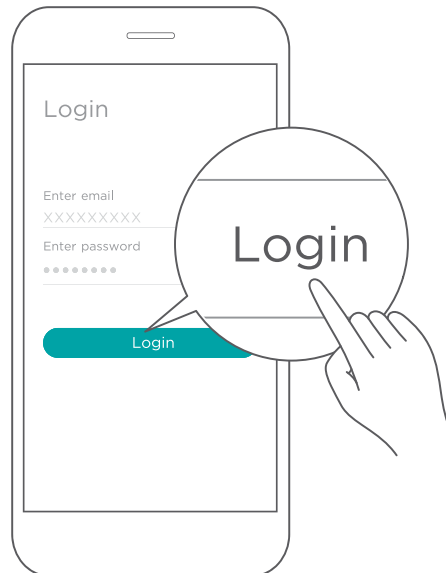

## STEP 3: Connecting the Device

- 1) Upon logging in, a message may appear stating "Smart devices discovered nearby." Tap to add the device.

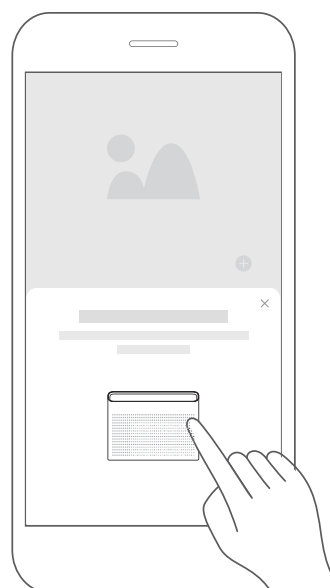

- 2) If no message appears, tap on "+" and select the device from the list of nearby available devices. If the device is not listed, it can be added manually by selecting the appropriate device category (i.e. Window AC).

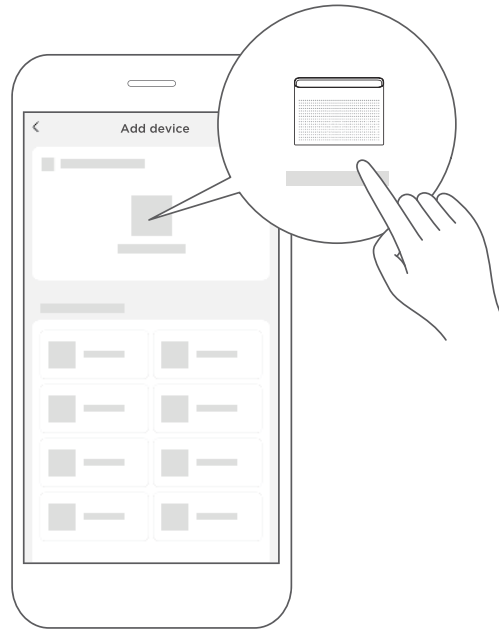

- 3) Follow the steps in the app to connect the device to the wireless network. If the connection fails, refer to the additional instructions provided in the app.

**For Window AC**

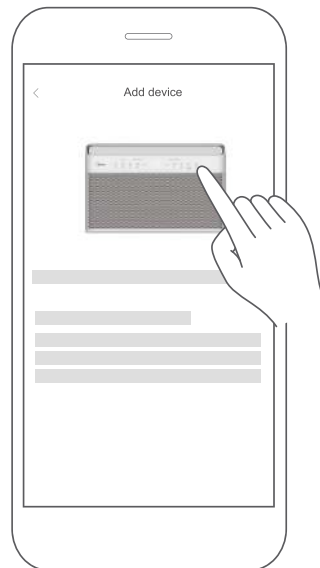

**For Portable AC**



#### STEP 4: Controlling the Device

After pairing successfully, a "card" will be created for the device in the SmartHome app.

Shortcuts for basic functions will appear on the "card" such as changing the temperature or switching the device on or off.

Tapping on the "card" will reveal additional features and settings. The actual UI design may look different from examples due to app updates.

\*"Card" is shown on Figure 1

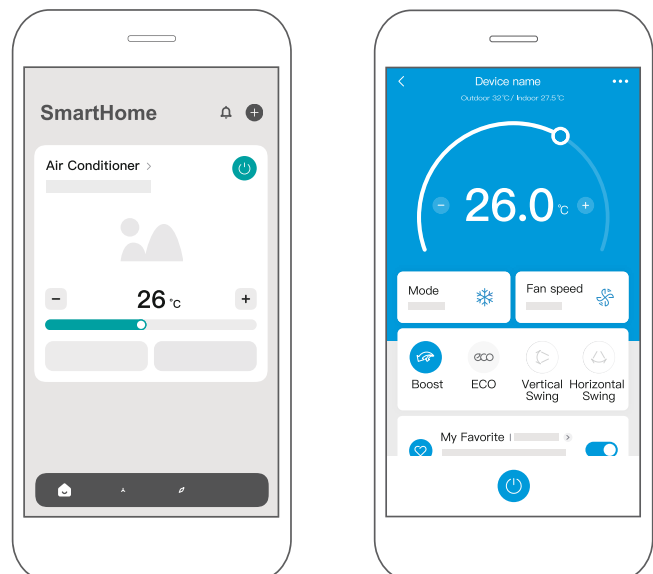

Figure 1

## 2. How to Use Matter

Matter is a connectivity technology that unifies the smart home by allowing devices and ecosystems (such as Alexa, Google Home and Apple Home) to speak the same language thus creating exciting new features and use cases.

To use Matter, at least one Matter-enabled smart speaker from Amazon, Google, or Apple, along with its respective app, is required.

- If a Matter-enabled smart speaker is available, proceed to the "How to Use Matter" instructions in the following pages.
- If a Matter-enabled smart speaker is not available, Matter cannot be used at this time. However, full product functionality can still be achieved through the SmartHome app. For instructions, refer to the "How to Use SmartHome App" section on page 34-35.

### Connect the air conditioner through Matter



Make sure the mobile device is connected to the wireless router.

Wireless router should support and turn on IPv6. Please make sure the smartphone connects to 2.4G but not 5G network.

### STEP 1: Connect to Smart Speakers

Select the preferred ecosystem (Alexa, Google Home, or Apple Home) and ensure that a Matter-enabled product, such as a smart speaker, is connected to the wireless router.

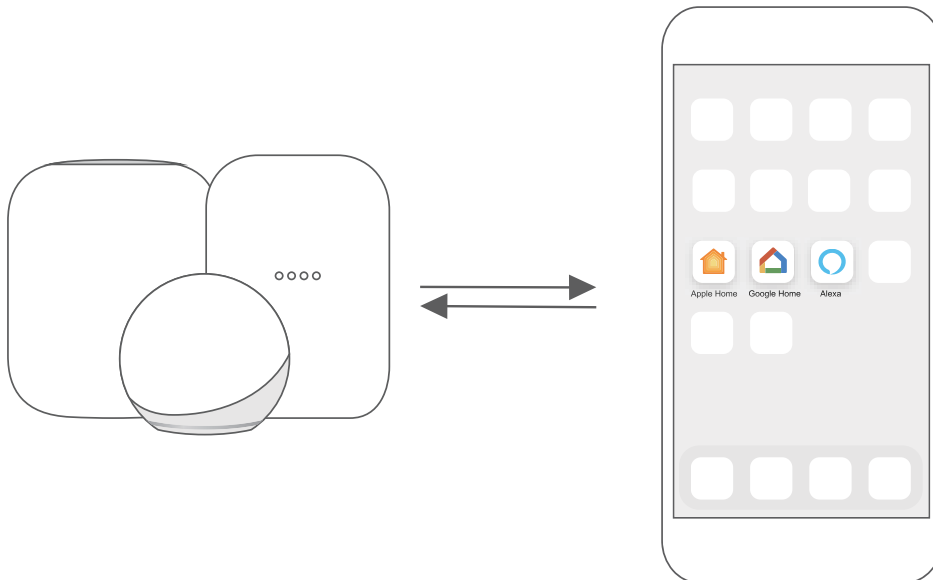

### STEP 2: Turn On Bluetooth

Turn on Bluetooth on the mobile device.

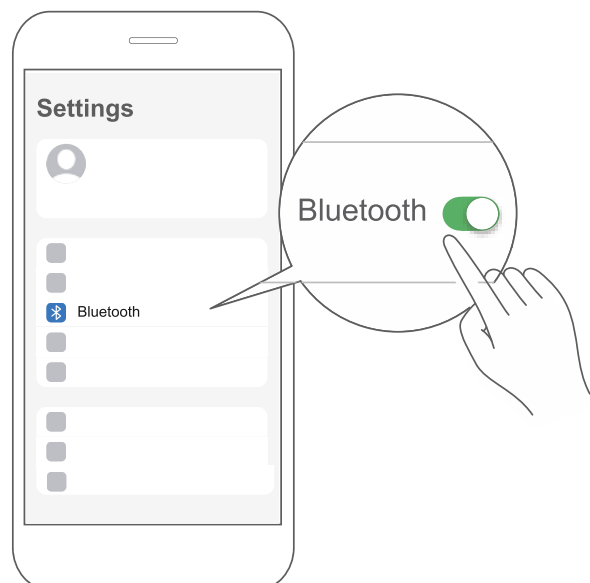

### STEP 3: Enter AP Mode

Window AC: Hold down the CONNECT / Power button for 3 seconds to begin the pairing process ("AP" will appear on the AC's display).

Portable AC: Hold down the SWING / Power button for 3 seconds to begin the pairing process ("AP" will appear on the AC's display).

#### NOTE

Entering AP pairing mode may vary between different AC models, please follow the instructions of the AC panel.

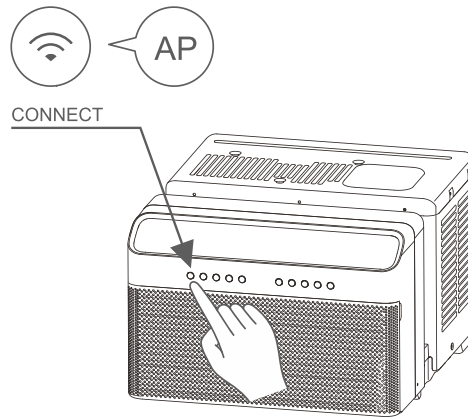

Window AC

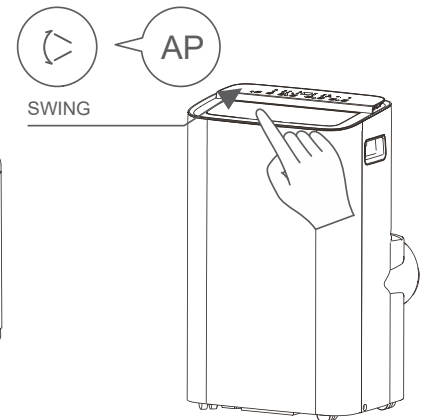

Portable AC

### STEP 4: Open App

Open the Alexa, Google Home or Apple Home app on the mobile device.

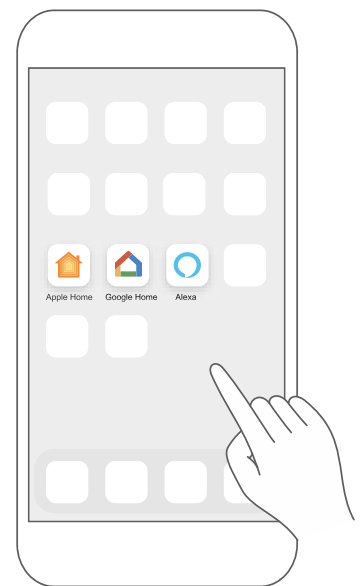

### STEP 5: Scan Matter QR code

Tap the "+" and "Add Device/Accessory" or tap "+Add" in the app and then select Matter device and scan the Matter QR code found on the side of the AC device.

Follow the respective instructions in the Alexa, Google Home or Apple Home app to complete the pairing process.

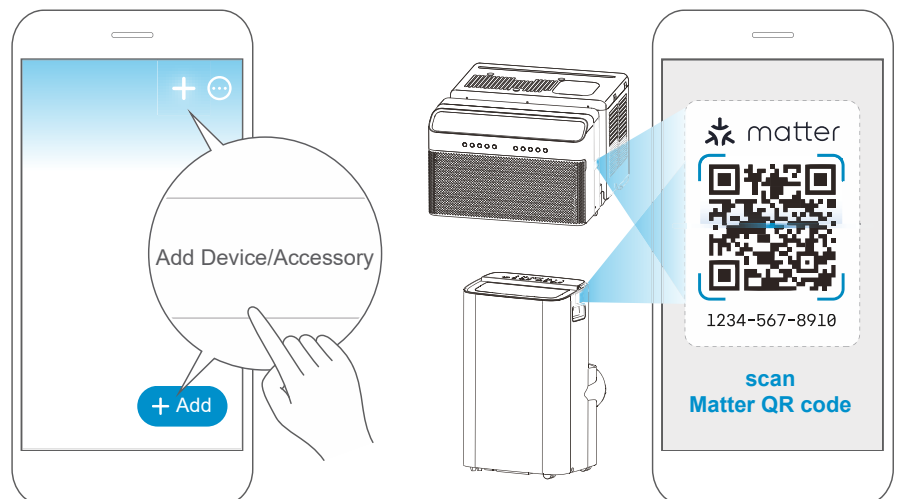

## STEP 6: Control Device

After pairing is successful, the AC's temperature, mode settings etc. can be controlled through the respective ecosystem app and smart speaker.

Due to a compatibility issue, the temperature value shown in the Alexa, Google Home or Apple Home app may be 1 degree different from that displayed on the air conditioner. However, this will not impact the device's ability to cool the room.

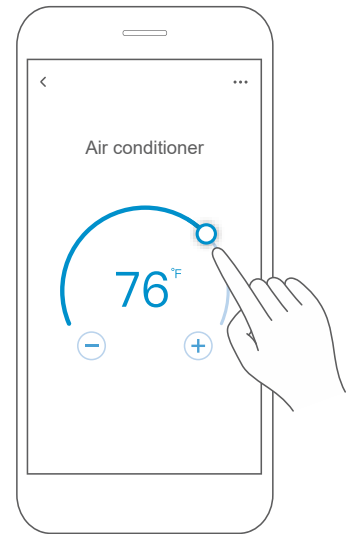
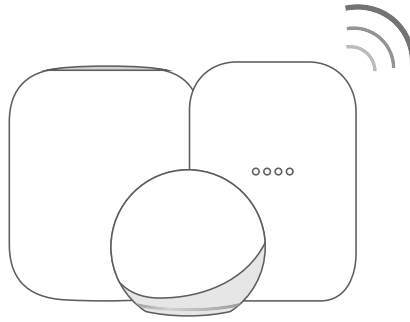

App & Smart Speakers can support Matter only when using these versions or above.

Device	Version
iPhone	iOS16.5
Apple Home Pod	16.5
Android	Google Play services min version: 22.36.15 Google Home app (GHA) min version: 2.58.24.1 - dogfood
Google Home Hub	Google Hub fi rmware min version: 1.56.324896 (appears on hub as Chromecast fi rmware version)
Alexa App	2.2.536317
Alexa Echo Device	9094439556

### NOTE

- Setup processes and features may vary between ecosystems.
- The functions shown in the Alexa, Google Home or Apple Home apps may change with updates to their products or apps.
- Make sure the Matter enabled app is up to date to ensure the best experience.
- Periodically, the device's software will update to improve the experience. Device software updates can be accomplished through the SmartHome app.
-  matter is developed by the Connectivity Standards Alliance TM. This brand, related logos, and marks are trademarks of the Alliance, all rights reserved.
- Use of the Works with Apple badge means that an accessory has been designed to work specifically with the technology identified in the badge and has been certified by the developer to meet Apple's performance standards. Apple is not responsible for the operation of this device or its compliance with safety and regulatory standards.

## Declaration of Conformity

FCC ID: 2ADQOMDNA23

IC: 12575A-MDNA23

This device complies with Part 15 of the FCC Rules and Industry Canada's licence exempt RSSs.

Operation is subject to the following two conditions:

- (1) This device may not cause interference;
- (2) This device must accept any interference, including interference that may cause undesired operation of the device.

Only operate the device in accordance with the instructions supplied.

Changes or modifications to this unit not expressly approved by the party responsible for compliance could void the user's authority to operate the equipment.

This device complies with FCC radiation exposure limits set forth for an uncontrolled environment. In order to avoid the possibility of exceeding the FCC radio frequency exposure limits, human proximity to the antenna shall not be less than 20cm (8 inches) during normal operation.

### NOTE

This equipment has been tested and found to comply with the limits for a Class B digital device, pursuant to part 15 of the FCC Rules. These limits are designed to provide reasonable protection against harmful interference in a residential installation.

This equipment generates, uses and can radiate radio frequency energy and, if not installed and used in accordance with the instructions, may cause harmful interference to radio communications. However, there is no guarantee that interference will not occur in a particular installation. If this equipment does cause harmful interference to radio or television reception, which can be determined by turning the equipment off and on, the user is encouraged to try to correct the interference by one or more of the following measures:

- Reorient or relocate the receiving antenna.
- Increase the separation between the equipment and receiver.
- Connect the equipment into an outlet on a circuit different from that to which the receiver is connected.
- Consult the dealer or an experienced radio/TV technician for help.

We, hereby declare that this device is in compliance with the relevant provisions of RE Directive 2014/53/EU. A copy of the full DoC is attached (European Union products only).

# WARRANTY

## Air Conditioner Limited Warranty

This unit is protected by this Limited Warranty:

Warranty service must be obtained from Midea Consumer Services or an authorized Midea servicer.

---

### Warranty

- One Year Limited Warranty from the date of delivery or the purchase date, whichever is later.
- 

### NORMAL RESPONSABILITIES OF THE CONSUMER\*\*

**This warranty applies only to products in ordinary household use, and the consumer is responsible for the items listed below:**

1. Proper use of the appliance in accordance with instructions provided with the product.
2. Routine maintenance and cleaning necessary to keep the good working condition.
3. Proper installation by an authorized service professional in accordance with instructions provided with the unit and in accordance with all local plumbing, electrical and/or gas codes.
4. Proper connection to a grounded power supply of sufficient voltage, replacement of blown fuses, repair of loosen connections or defects in house wiring.
5. Expenses for making the unit accessible for servicing.
6. Damages to finish after intallation.

### EXCLUSIONS

**This warranty does not cover the following:**

- 1) Failures resulting from damage to the unit while in possession (excluding damage due to defects or malfunctions), improper installation, or unreasonable use of the unit are not covered. This includes, but is not limited to, failure to perform necessary maintenance or to adhere to the provided "Installation and Operating Instructions."
- 2) Damages caused by serviced performed by persons other than those authorized by Midea customer service; or external causes such as abuse, misuse, inadequate power supply or acts of God.
- 3) If the unit is utilized for commercial, business, rental, or any application beyond consumer use, no warranties are provided, whether express or implied. This includes, but is not limited to, any implied warranty of merchantability or fitness for a particular use or purpose.
- 4) Products without original serial numbers or products that have serial numbers which have been altered or cannot be readily determined.

**NOTICE: Some states do not allow the exclusions or limitation of incidental or consequential damages. So this limitation or exclusion may not apply.**

### IF SERVICE IS NEEDED...

Keep the bill of sale, delivery slip, or some other appropriate payment Record.

The date on the bill establishes the warranty period, should service be required.

If service is performed, it is best to obtain and keep record of all receipts.

This written warranty does not confer any specific legal rights. Rights may vary depending on the state or jurisdiction.

Service under this warranty must be obtained by following these steps, in order:

- 1) Contact Midea Consumer Services or an authorized Midea services at 1 866 646 4332.
- 2) If there is a question as to where to obtain service, contact our consumer relations Departament.







*make yourself at home*



[www.midea.com](http://www.midea.com)

© Midea 2024 all rights reserved

CWS003IU-TYBPN8(WA)  
16120300A35412

