

# G10-212

## User's Manual

Chronograph model

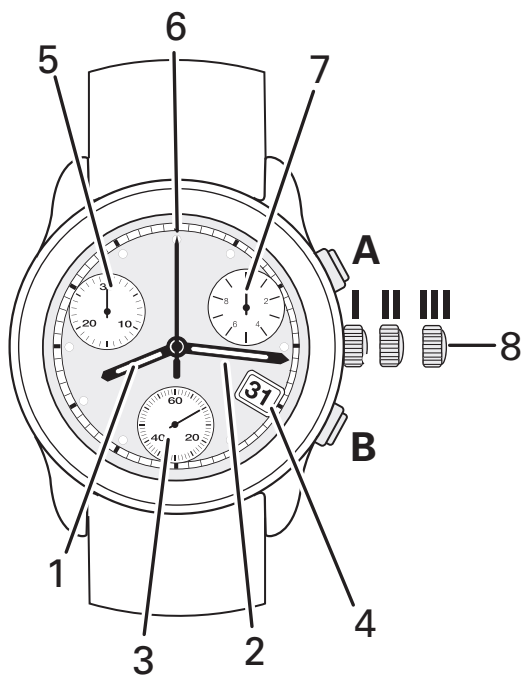

Football model

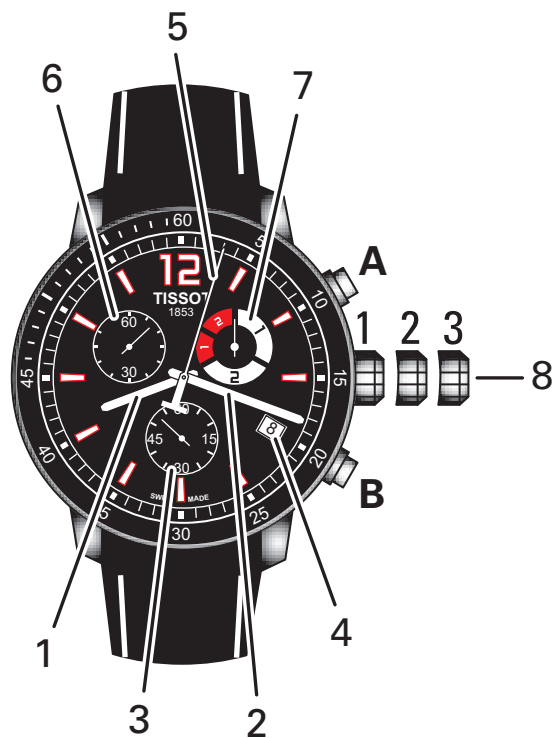

### Display and functions

- ❶ Hour hand
- ❷ Minute hand
- ❸ Seconds hand (direct-drive)
- ❹ Calendar
- ❺ 30-minute counter
- ❻ 60-second counter
- ❼ 1/10 second counter

#### ⓐ 3-position crown

- I Neutral position (screwed down\*, not pulled out)
- II Synchronisation and date setting position (unscrewed\*, half pulled out)
- III Time-setting position (unscrewed\*, fully pulled out)

- ❶ Hour hand
- ❷ Minute hand
- ❸ Seconds hand (direct-drive)
- ❹ Calendar
- ❺ 45-minute counter
- ❻ 60-second counter
- ❼ Match phase counter

#### ⓐ 3-position crown

- I Neutral position
- II Date-setting position
- III Time-setting position

**\* Models with a screw-down crown:**  

 IA Neutral position (unscrewed, not pulled out)  
 IB Initial position (screwed down, not pulled out)

## Acknowledgements

Thank you for choosing a chronograph from TISSOT®, a Swiss brand among the most highly renowned in the world. Meticulously designed, using only the highest quality materials and components, your chronograph is protected against shock loads, variations in temperature, water and dust.

This user manual applies to TISSOT® quartz chronographs with a G10.212 movement, and is divided into several model-specific chapters.

The **Chronograph model** enables you to measure events lasting up to 30 minutes, and offers you the following functions:

- Standard chronograph function (START/STOP);
- “ADD” function (partial times);
- “SPLIT” function (intermediate times).

The **Football model** enables you to time football matches, and offers you the following functions:

- Half counter;
- Added time counter;
- Extra time counter.

To ensure that your chronograph operates with perfect precision for many years to come, we advise you to pay careful attention to the advice given in this user manual.

## Chronograph model - Use

### Model with a screw-down crown

To ensure even better water resistance, certain models are fitted with a screw-down crown. Before setting the time or date, you must first unscrew the crown to position **IB**, so that you can pull it out to position **II** or **III**.

**Important!** After every operation, the crown must be screwed back down to maintain the water-resistance of the watch.

### Setting the time

- Pull the crown out to position **3**, and turn it forward or backward to set the desired time.
- Synchronise the small seconds hand at 6 o'clock with an official time signal (radio/TV/Internet), by pulling the crown out to position **3**; the hand will stop. Once the time is synchronised, push the crown back into position **1**.

### Winding

Quartz watches do not need to be wound.

### Setting the date

- Pull the crown out to position **II** and turn it anticlockwise until the desired date is displayed.

### Simple timing

The «simple timing» function enables you to measure isolated events.



START, press **A**

STOP, press **A**

**Time readout (as per example opposite):**

- 5 minutes,
- 57 seconds,
- 7/10ths of a second

Reset, press **B**

**NB:** before each timing operation, the chronograph hands must be at their start points. If necessary, refer to the “Resetting the counters” paragraph.

**Note:** all the timing functions are available with the crown pressed into position **I**.

### Tachymeter (depending on model):

The tachymeter allows you to measure the speed of an object moving at a constant speed. Start the chronograph and then stop it when you have travelled a distance of 1 km; the chronograph hand will be pointing to a number on the tachymeter scale indicating the speed in km/h.

### ADD function (partial times)

The “ADD” function enables you to measure consecutive events without having to reset in between. Each time is added to the previous total.



START, press **A**

STOP Readout, press **A**

RESTART, press **A**

STOP Readout, press **A**

RESTART, press **A**

STOP Readout, press **A**

Reset counters, press **B**

### SPLIT-TIME function (intermediate times)

The SPLIT-TIME function enables you to stop the hands to read an intermediate time, without interrupting the timing. When you restart, the chronograph hands "catch up" to the ongoing elapsed time.



START, press **A**  
 SPLIT 1, press **B**  
**Time 2 readout**  
 - 5 minutes,  
 - 4 seconds,  
 - 6/10ths of a second



RESTART, press **B**  
 SPLIT 2, press **B**  
**Time 2 readout**  
 - 15 minutes,  
 - 36 seconds,  
 - 8/10ths of a second

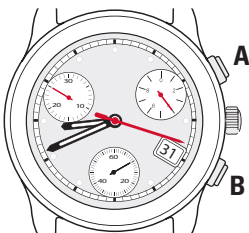

RESTART, press **B**  
 STOP, press **A**  
**Final time readout (cumulative time)**  
 - 25 minutes,  
 - 18 seconds,  
 - 4/10ths of a second  
 Reset counters, press **B**

## Chronograph model - Settings

### Resetting the counters

The chronograph hands may need to be reset if they are not in the 12 o'clock position at rest. If necessary, proceed as follows:

Pull the crown out to position **II**;

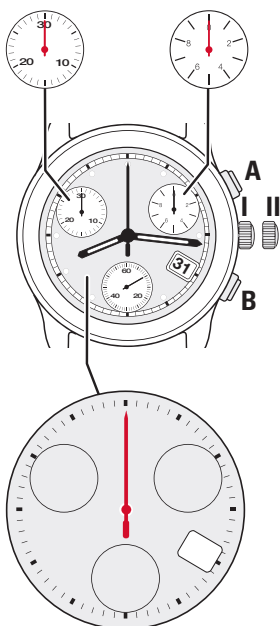

Press push-button **A** to select the hand to reset;  
 - the selected hand will turn through a complete revolution.  
 Press push-button **B** to move the hand to the correct position;  
 - 12 o'clock precisely.  
 Press push-button **A** to select the next hand;  
 Follow the same procedure for the 3 hands;  
 Push the crown back into position **I** to exit reset mode.

## Football model - Use

### Timing a football match

The timing function allows you to time all the phases of a football match.

**Note:** all the timing functions are available with the crown in position **I**.

#### Procedure:

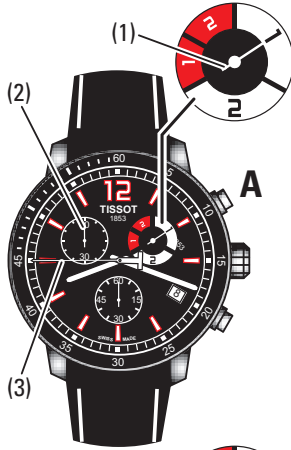

Press **A** to start timing from the first whistle;

- hand (1) will indicate the first half;
- hand (2) will indicate the seconds;
- hand (3) will time the minutes.



At half-time, press **A** to stop timing;

- hand (1) will indicate the first half;
- hands (2) and (3) will stop.

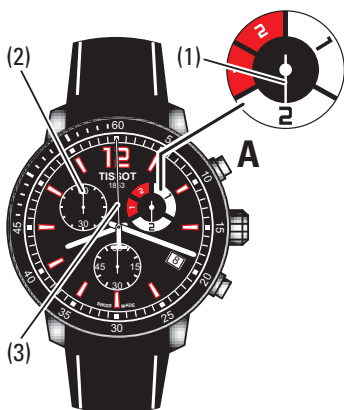

When the second half kicks off, press **A** to resume timing;

- hand (1) will indicate the second half;
- hands (2) and (3) will move back to the 12 o'clock position, and then start timing again.

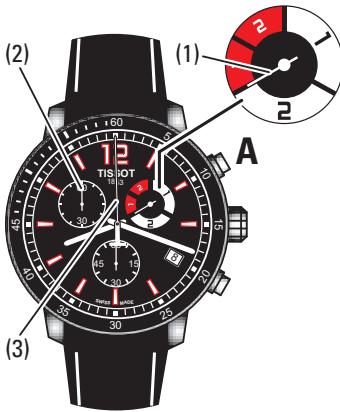

After the end of normal time, hands (2) and (3) will indicate the stoppage time;

When the final whistle blows, press **A** to stop timing;  
- hand (1) will indicate the end of normal time.



If extra time is to be played, press **A** again to start timing;

- hand (3) will move to the 9 o'clock position to measure the 15 minutes of the first half of extra time.

**Reset**

**Note:** to reset the watch, there must be no active timing.



Press **A** to stop the active timing.

Press **B** to reset the watch to time the next match.

## Modèle Football - Settings

### Resetting the indicators

The football chronograph hands (45-min and 60-second) and the match phase counter hand may need to be reset if they are not in the 12 o'clock position at rest.

Pull the crown out to position **II** - the hands will move to the 12 o'clock position;



Press push-button **A** to select the hand to reset;

- the selected hand will turn through a complete revolution and return to the 12 o'clock position.

Press push-button **B** to move the hand to the correct position;

- 12 o'clock precisely.

Press push-button **A** to select the next hand;

Follow the same procedure for the 3 hands;

Push the crown back into position **I** to exit reset mode.

## Water-resistance

TISSOT® watches are designed to withstand a pressure of up to 3 bar (30 m / 100 ft), 5 bar (50 m / 165 ft), 10 bar (100 m / 330 ft), 20 bar (200 m / 660 ft) or 30 bar (300 m / 1000 ft), depending on the information shown on the case-back.

A watch cannot be permanently guaranteed absolutely water-resistant. It may be affected by ageing of the gaskets or by an accidental impact on the watch. We recommend that you have your watch's water resistance checked once a year by an approved TISSOT® service centre.

## Care and maintenance

### Temperature

Do not expose your watch to sudden temperature changes (exposure to sunlight followed by immersion in cold water) or extreme temperatures (over 60°C (140°F) or below 0°C (32°F)).

### Magnetic fields

Do not expose your watch to intense magnetic fields such as those generated by speakers, mobile phones, computers, refrigerators or other electromagnetic appliances.

### Shocks and impacts

Avoid thermal shocks or impacts, since they may harm your watch. In the event of a violent impact please have your watch checked by an approved TISSOT® service centre.

### Harmful products

Prevent your watch from coming into any direct contact with solvents, detergents, perfumes, cosmetic products etc., since they may damage the bracelet, the case or the gaskets.

### Cleaning

We would advise you to clean your watch regularly (except for the leather strap) using a soft cloth and lukewarm soapy water. After immersion in salty water, rinse your watch in fresh water and leave it to dry completely.

## Services

Like any precision instrument, a watch must be serviced regularly for optimum operation. As a general rule, we recommend that you have your watch checked every 3 to 4 years by your approved TISSOT® retailer or service centre. However, please note that depending on the climate and the conditions of use of the watch, a shorter interval may be required. To benefit from the highest standards of service and to ensure your guarantee remains in force, please always contact an approved TISSOT® retailer or service centre.

## Availability of spare parts

From the stoppage date of the watch production, TISSOT® guarantees the availability of its spare parts for a minimum period of 10 years for standard watches, and for a period of up to 20 years for gold watches. If for any reason production of a particular spare part is stopped or deferred, TISSOT® reserves the right, at its sole discretion, to offer the customer an alternative solution.

## Replacing the battery

TISSOT® quartz watches have the incomparable precision of quartz. Their power reserve is usually more than 2 years in continuous use (depending on how often the watch functions are used).

### Replacing the battery

Once the battery has been drained, it must be replaced without delay by a TISSOT® approved service centre. Battery type: silver oxide and zinc button cell, 1.55V, no.394.

### Collection and treatment of end of life quartz watches\*



This symbol indicates that this product should not be disposed of as household waste. It must be returned to an approved collection point. By following this procedure you will contribute to safeguarding the environment and human health. Recycling the materials will help to conserve natural resources.

\* Valid in European Community member states and in any countries with comparable legislation.