

ASSEMBLY AND INSTALLATION INSTRUCTIONS

C0122

WARNING: TO AVOID RISK OF ELECTRICAL SHOCK, BE SURE TO SHUT OFF POWER BEFORE INSTALLING OR SERVICING THIS FIXTURE.

NOTES: 1. Before installing, consult local electrical codes for wiring and grounding requirements.
2. READ AND SAVE THESE INSTRUCTIONS.

Hardware Package (included):

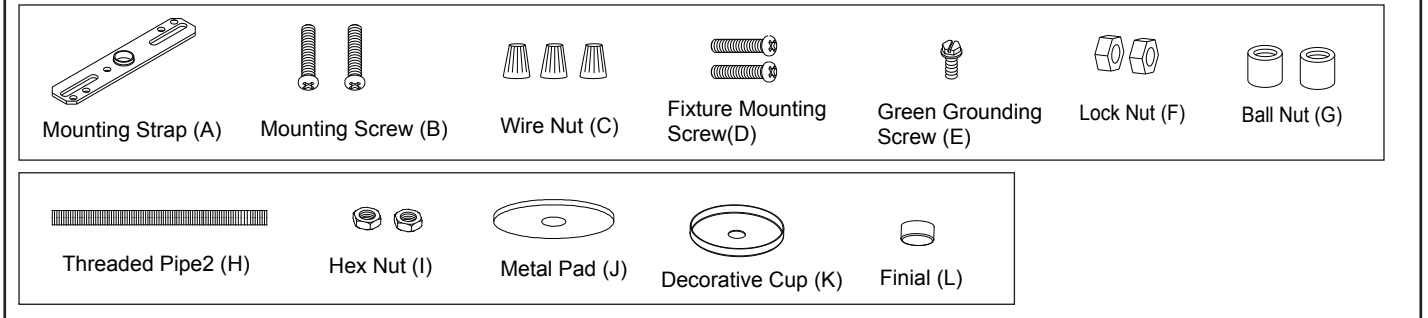

Installation Steps

Turn off the power at fuse or circuit box

1. Thread the fixture mounting screws through mounting strap, and then secure them with two lock nuts. Adjust the length of fixture mounting screws if necessary.
2. Attach mounting strap to the outlet box using two mounting screws.
3. Thread the fixture wire through the washer, hex nut and threaded pipe1
4. Secure the threaded pipe1 into the coupling of the shade with the washer and hex nut until tightened.
5. Attach the tube onto the cover of the shade and thread the fixture wire through the cover, canopy, metal pad1, washer and hex nut. Place the cover and canopy onto the tube through the threaded pipe1, then tighten them with the metal pad, washer and hex nut.
6. Secure the threaded pipe2 into the coupling of the housing and tighten it with hex nut.
7. Slip the metal pad2, diffuser and decorative cup up through the threaded pipe2, and then secure them with the finial.

NOTE: The depth of hex nut in threaded pipe2 may need to be adjusted to properly fit the diffuser. The diffuser should be flatly laid on four brackets, and the frosting of the diffuser should be faced down.

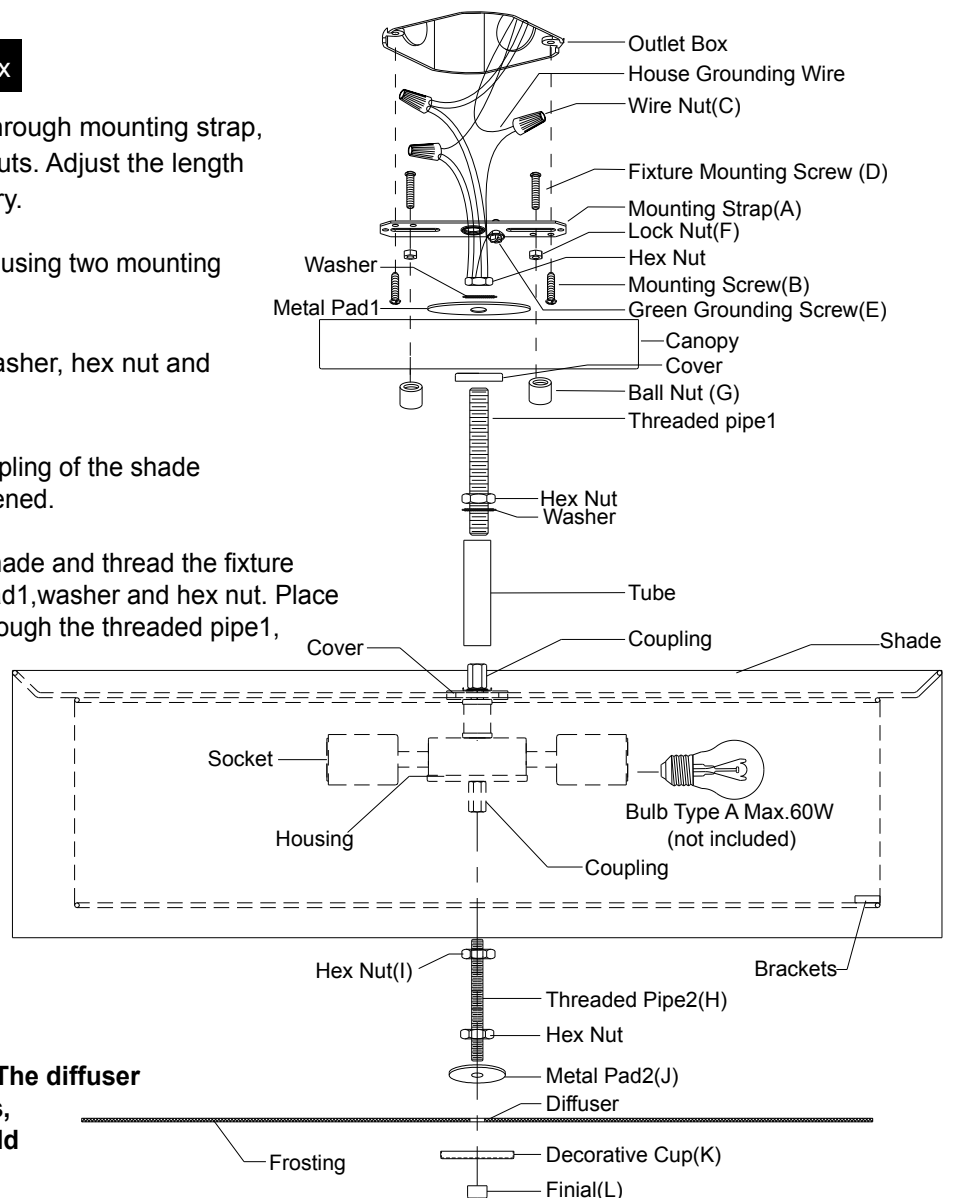









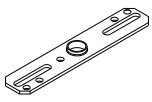



8. Install bulbs (not included). Check relamping label at socket area or packaging for maximum allowed wattage.
9. Pull out the source wires from the outlet box. Make wire connections using wire nuts as follows:
 - Connect the hot wire (usually black insulation) from the fixture to the black wire from the power source.
 - Connect the neutral wire (usually white insulation) from the fixture to the white wire from the power source.
 - Attach the fixture grounding wire (usually green insulation or bare wire) to the mounting strap with the green grounding screw, and then connect it to the house grounding wire with the wire nut.
 Carefully put the wires back into the outlet box.
10. Attach the canopy to the mounting strap by inserting the fixture mounting screws, and then secure it with two ball nuts.

Turn on the power at fuse or circuit box

The following parts are available for re-order if damaged or missing.

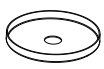
Spare Parts List:

 Mounting Strap (A)	 Mounting Screw (B)	 Wire Nut (C)	 Fixture Mounting Screw (D)	← Mounting Hardware 5638MM (1 SET)
 Green Grounding Screw (E)	 Lock Nut (F)	 Ball Nut (G)		
 Threaded Pipe2 (H)	 Hex Nut (I)	 Metal Pad (J)	 Decorative Cup (K)	← Mounting Accessory 5639MM (1 SET)
		 Finial (L)		

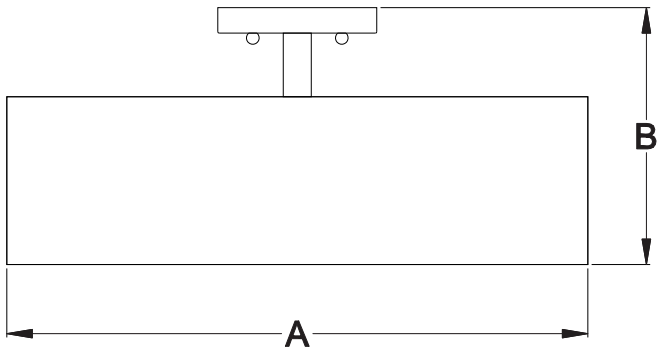

C0122
 A: 24"
 B: 10-3/8"

