

PHILIPS

Home Access

Electronic deadbolt

1000 series

User Manual

Register your product and get
support at www.philips.com/support



Contents

1 Warnings & Safety **02**

Safety
Caution
Returns & Disposal

2 How to Install **03**

Parts List
Assembly View
Install the Lock

3 How to Setup **12**

Download the Philips Home Access App
Create a User Account
Add the Device

4 How to Use **13**

Feature Definitions
Factory Reset & Default Settings
Format of Entry Methods
Program the Lock
Lock & Unlock

5 Troubleshooting **21**

6 Warranty **24**

1 Warnings & Safety

Safety

- ◆ Before using this product, please read and understand all instructions. Damage caused by failure to follow the instructions is not covered by the warranty.
- ◆ Only use components the manufacturer provided and suggested accessories.
- ◆ Only use AA alkaline batteries.
- ◆ Do not forcibly disassemble the product to trigger an alarm or damage the product.
- ◆ Do not scrape the fingerprint sensor with sharp objects as this may cause permanent damage.
- ◆ Do not remove the batteries during lock setup and operation.
- ◆ Change the default master PIN code immediately after completing the installation.

Caution

- ◆ Do not place the batteries near fire sources.
- ◆ Do not connect the 2 poles of the batteries to metals to avoid a short circuit and potential explosion.
- ◆ Any replacement component should be performed by Philips, a Philips-authorized service center, or a professional technician.
- ◆ Do not use parts or accessories manufactured by others, except batteries.
- ◆ Do not expose products to places that have water leakage or splashing.

Returns & Disposal

- ◆ Locks can be returned at an authorized Philips service center. Appropriate compensation will be provided if the returned product meets Philips's conditions.
- ◆ Please follow local regulations and do not throw the used products or batteries into normal household waste.

2 How to Install

Parts List



① Exterior Assembly

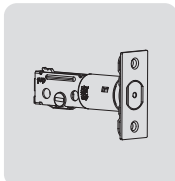

② Latch Bolt

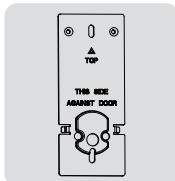

③ Mounting Plate

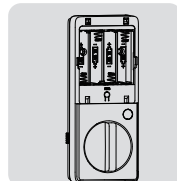

④ Interior Assembly

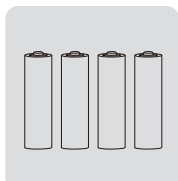

⑤ AA Batteries (4)

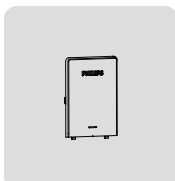

⑥ Battery Cover

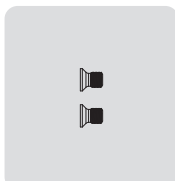

⑦ Interior Assembly Screws (2)

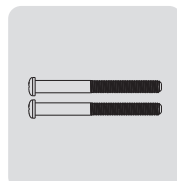

⑧ Mounting Plate Screws (2)

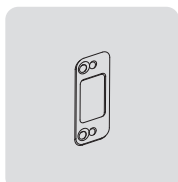

⑨ Reinforcement Plate (Optional)

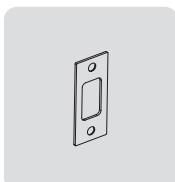

⑩ Strike Plate

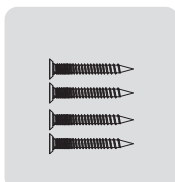

⑪ Strike Plate Screws (2)
Reinforcement Plate Screws (2)

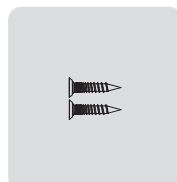

⑫ Latch Bolt Screws (2)

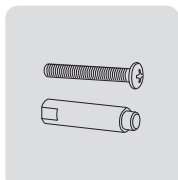

⑬ Upper Screw & Screw Post (Optional)

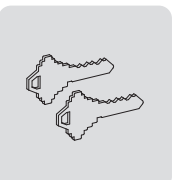

⑭ Backup Keys

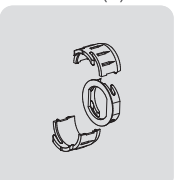

⑮ Drive-In Collar (Optional)

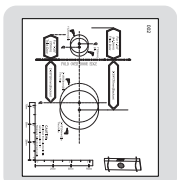

⑯ Drilling Template



⑰ User Manual



⑱ Quick Start Guide

Assembly View

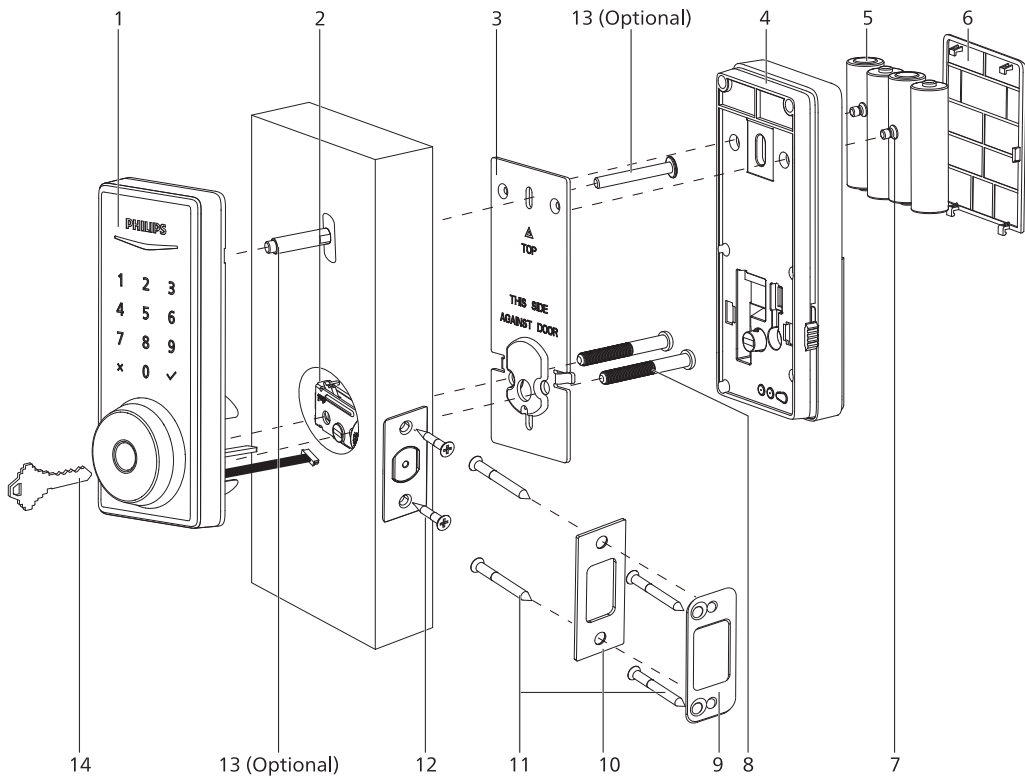

- | | |
|---------------------------------|---|
| 1. Exterior Assembly | 8. Mounting Plate Screws (2) |
| 2. Latch Bolt | 9. Reinforcement Plate (Optional) |
| 3. Mounting Plate | 10. Strike Plate |
| 4. Interior Assembly | 11. Strike Plate Screws (2) |
| 5. AA Batteries (4) | Reinforcement Plate Screws (Optional) (2) |
| 6. Battery Cover | 12. Latch Bolt Screws (2) |
| 7. Interior Assembly Screws (2) | 13. Upper Screw and Screw Post (Optional) |
| | 14. Backup Keys (2) |

Exterior Assembly

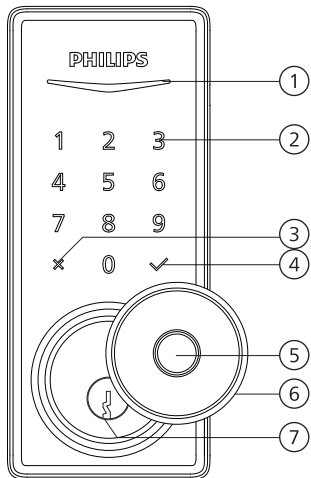

1	Status Indicator
2	Touchscreen Keypad
3	Cancel Key
4	Confirm Key
5	Fingerprint Sensor
6	Keyhole Cover
7	Keyhole

Interior Assembly

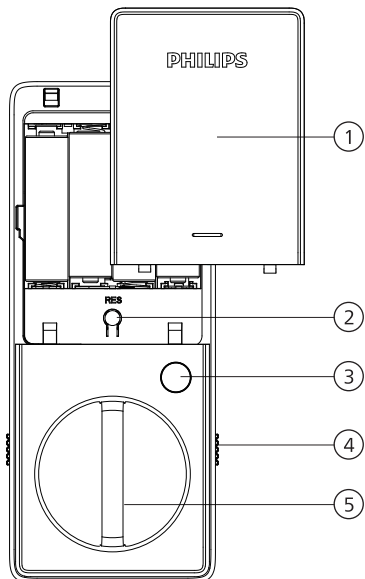

1	Battery Cover
2	Reset Button
3	Privacy Button
4	Installation Buckle
5	Thumb Turn

Install the Lock

Required Tools



#2 Phillips Screwdriver

Prepare the Door and Check the Dimensions

- ① Measure to confirm that the hole in the door is 1-1/2" or 2-1/8" (38mm or 54mm).
Measure to confirm that the hole in the door edge is 1" (25mm).
- ② Measure to confirm that the backset is either 2-3/8" or 2-3/4" (60mm or 70mm).

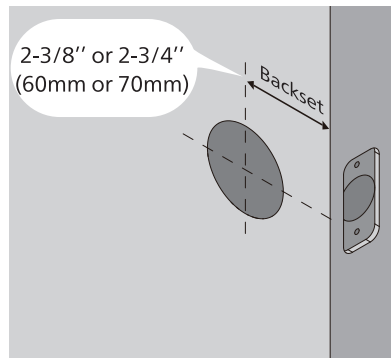
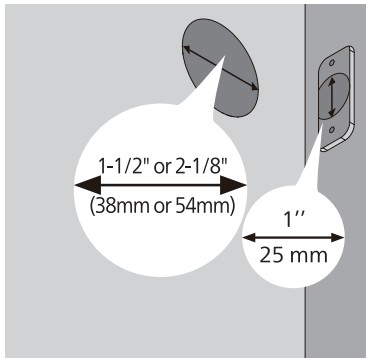

- ③ Measure to confirm that the door is 1-3/8" to 2" (35mm to 50mm) thick.
- ④ Make sure the hole in the door frame is drilled a minimum of 1" (25mm) deep to leave enough space for the deadbolt to extend into the door frame when the door is locked.

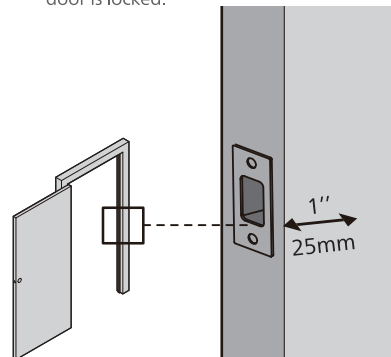
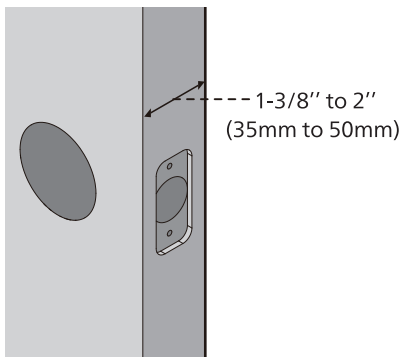

⚠ Attention

Make sure the door frame is aligned with the door and there are no obstructions in the door frame.

5 OPTIONAL: Drill a hole for Upper Screw.

⚠ Attention

Installing this screw onto the Exterior Assembly is OPTIONAL. It is used for additional security or when a door is weak or warped.

If you install this screw, you need to drill a hole (19/32") in the door before starting the installation.

Drilling Template

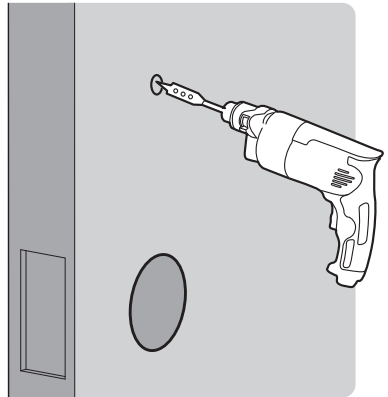
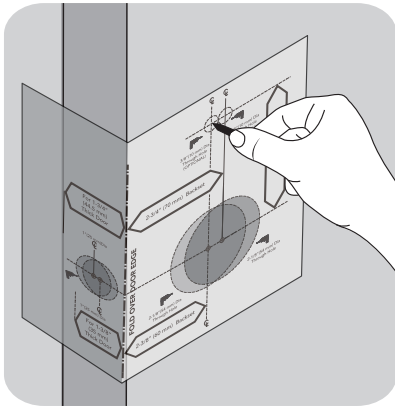

⑥ Determine the backset and adjust the Latch Bolt.

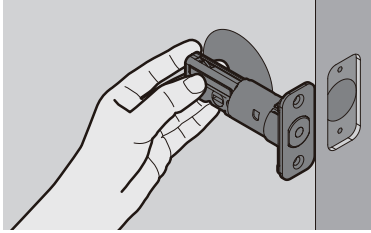

Hold the Latch Bolt in front of the door hole, with the Latch Bolt face flush against the door edge. Is the slotted hole centered in the door hole?

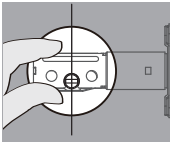

YES

No adjustment is required.

Proceed to the next step.

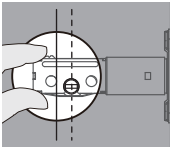

NO

The slotted hole is NOT centered.

Rotate and pull the Latch Bolt as shown to extend it.

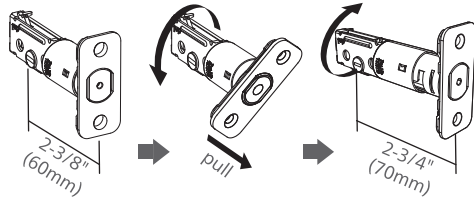

⑦ Install the Latch Bolt.

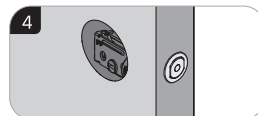
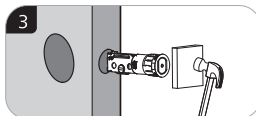
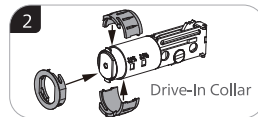
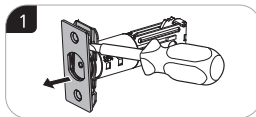
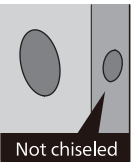
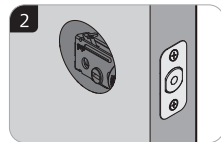
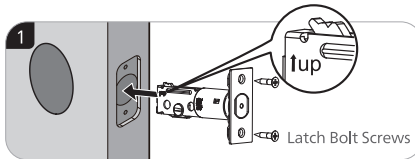

- 8 Use a screwdriver to confirm that the deadbolt locks and unlocks smoothly.

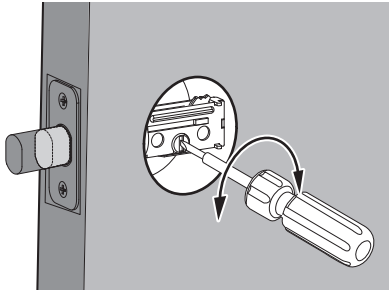

- 9 Install the Strike Plate on the door frame.

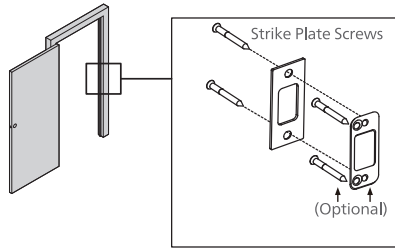

Attention

Make sure the hole in door frame is drilled a minimum of 1"(25mm) deep.

Install the Exterior Assembly

Attention

Before installing the Exterior and Interior Assembly, make sure the Latch Bolt is fully retracted (in the unlocked position).

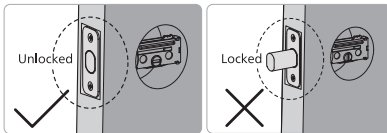

Do not insert the key when you are installing.

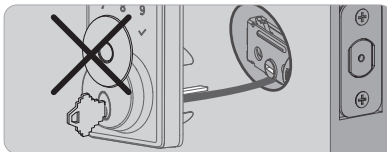

Measure the diameter of the hole in the door.

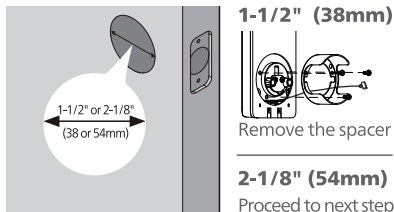

- 10 With the Latch Bolt fully retracted (in the unlocked position), route the cable below the Latch Bolt, and insert the tailpiece through the slot in the Latch Bolt.

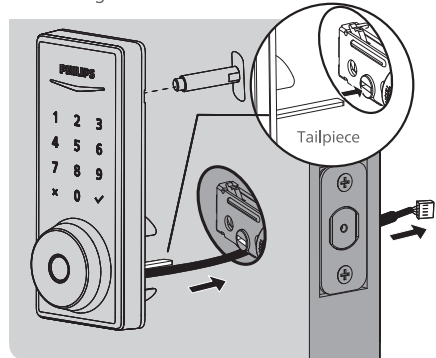

Attention

The Upper Screw & Screw Post on the top is OPTIONAL. It is used for additional security, or when a door is weak or warped.

- 11 Move the Installation Buckles on both sides of the Interior Assembly upwards to remove the Mounting Plate from the interior base.

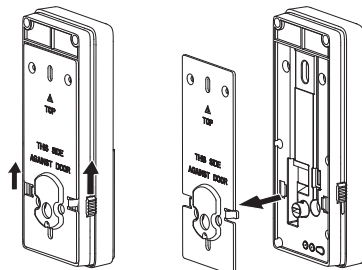

- 12 Secure the Mounting Plate with the Mounting Plate Screws. Do not overtighten screws.

⚠ Attention

Route the cable through the hole in the mounting plate.

The Upper Screw on the top is OPTIONAL.

Before installing the Upper Screw, fasten the Screw Post into the hole of the Exterior Assembly.

Keep parallel to door edge.

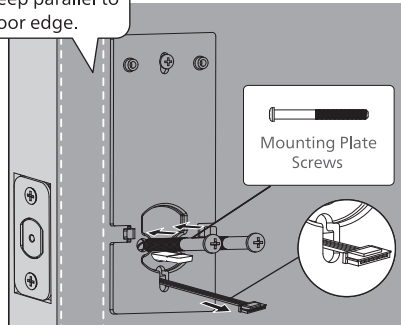

Install the Interior Assembly

- 13 Push the Battery Cover up in the direction as illustrated.

⚠ Attention

Do not load batteries before finishing the lock installation.

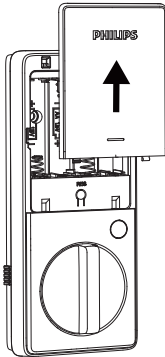

- 14 Insert the cable connector of the Exterior Assembly to the socket on the Interior Assembly. Push the connector in firmly until it is completely attached.

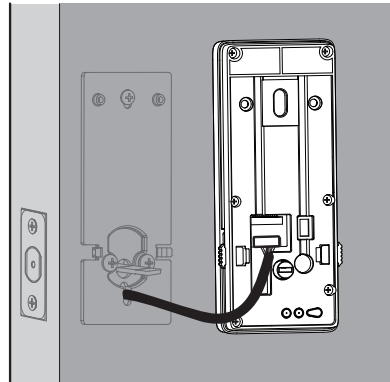

- 15 Keep the Thumb Turn in the vertical position, toggle the Installation Buckle upwards, and install the Interior Assembly.

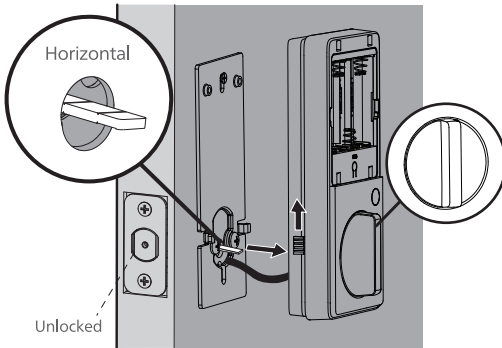

- 16 Attach the Interior Assembly to the Mounting Plate, toggle the Installation Buckle downwards, and fasten using the Interior Assembly Screws.

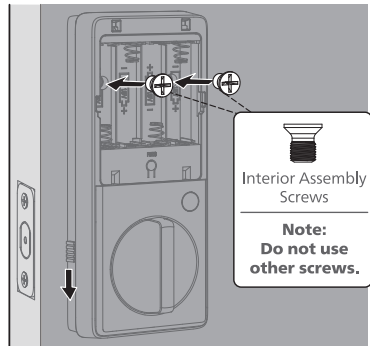

- 17 Install the AA alkaline batteries according to the direction guide inside the battery holder.

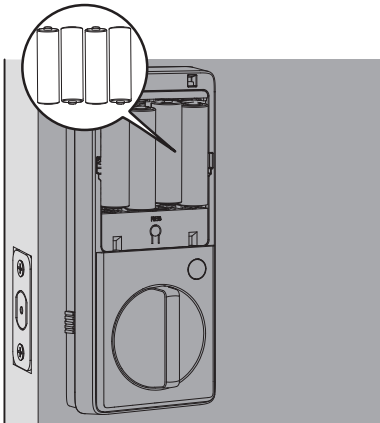

- 18 Press and hold the Reset Button for at least 5 seconds until you hear a beep. This activates the lock-handing process and must be completed before setting up the lock.

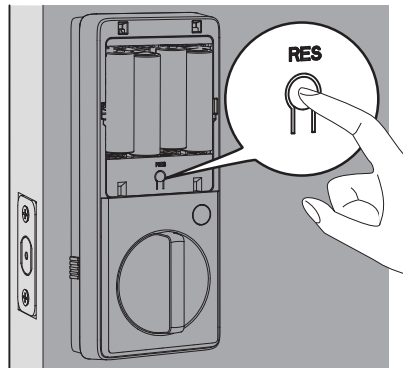

⚠ Attention

Ensure the cable is not pinched or the lock will not function properly.

Need help?



U.S.A. & Canada: +1(833)599-9111

3 How to Setup

Download the Philips Home Access App

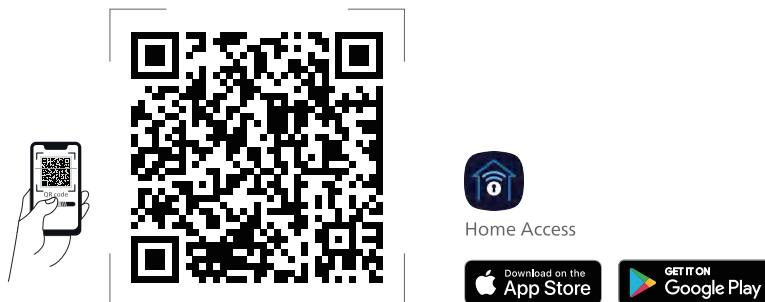

Scan the QR Code to download the Philips Home Access app.

Create a User Account

Register and log in to the Philips Home Access app.

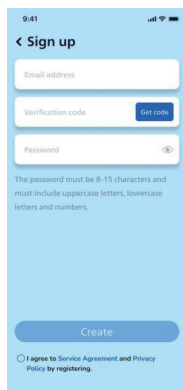
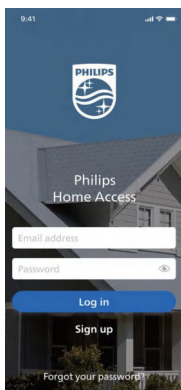

Add the Device

Tap the "Add device" button on the app.

Scan the QR Code or manually enter the ESN located on the back of the Battery Cover and complete the pairing steps following the in-app instruction.

⚠ Attention

Be sure to enter the correct Master PIN Code during the pairing process, or it may cause the One-Time PIN Code to fail.

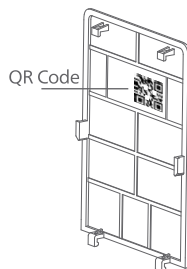

4 How to Use

Feature Definitions

Master PIN Code

Required for programming and adjusting settings. The Master PIN Code can be used to unlock the deadbolt in Away Mode and Privacy Mode. The default Master PIN Code (12345678) must be changed before programming. (Programming instructions refer to page 16.) The owner/manager should keep this information confidential.

Auto-Lock

The unit will automatically lock after it has been unlocked. This function is disabled by default. It can be set on the lock for a time delay between 30 and 180 seconds (Programming instructions refer to page 18).

Silent Mode

The sounds can be muted when pressing the keypad. However, you will still hear low battery warnings and system alerts. (Programming instructions refer to page 16.)

Away Mode

This is a safety feature when you leave your house for a vacation or long trip. Away Mode restricts all user codes until the Master PIN Code is entered on the keypad. When the lock is unlocked by the Thumb Turn, an alarm will sound for 1 minute.

By entering the Master PIN Code on the keypad, you can disable the alarm and the Away Mode. (Programming instructions refer to page 19.)

Privacy Mode

Push and hold the Privacy Button on the inside escutcheon for 3 seconds to activate the Privacy Mode. This will restrict all User PIN Code access. Privacy Mode will be disabled automatically after unlocking the door with the Thumb Turn or the Master PIN Code.

One-Time PIN Code (in-app feature)

Generated by the Philips Home Access app, the One-Time PIN Code can only be used once.

You can only generate One-Time PIN Codes for the 1000 series electronic deadbolt via the Philips Home Access app.

Factory Reset & Default Settings

This procedure deletes all user codes associated with the lock.

Restoring the lock will also activate the lock-holding process.

Press the Reset Button for at least 5 seconds until you hear the tone prompting you to restore the default settings.

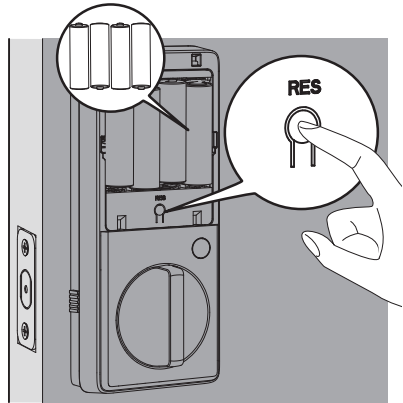

Function	Default Setting
Master PIN Code	12345678
Auto-Lock	Disabled
Silent Mode	Disabled
Shut Down Time	3 minutes
Away Mode	Disabled

Format of Entry Methods

1. Master PIN Code (4 to 10 digits): The default Master PIN Code is 12345678. Change the default Master PIN Code before programming other codes.
2. User PIN Code (4 to 10 digits): A total of 20 User PIN Codes can be programmed and stored in the lock.
3. User Fingerprint: 50 fingerprints can be programmed and stored in the lock.
4. Both Master and User PIN Codes do not support the following combination of numbers:

A. Forward number

A.

1	2	3	4	5	6	7	8
---	---	---	---	---	---	---	---

 ✕

B. Backward number

B.

8	7	6	5	4	3	2	1
---	---	---	---	---	---	---	---

 ✕

C. Repeated number

C.

2	2	2	2	2	2	2	2
---	---	---	---	---	---	---	---

 ✕

D. Contain existing code

D. If

5	6	8	3
---	---	---	---

 ✓

then

5	6	8	3	9	1
---	---	---	---	---	---

 ✕

and

9	1	5	6	8	3
---	---	---	---	---	---

 ✕

Program the Lock

⚠ Attention

The default Master PIN Code is 12345678. Change the default Master PIN Code before programming the lock. The indicator light will flash red when the code entered is not saved successfully.

If no button is pressed for more than 10 seconds, the lock will exit programming mode.

Touch the Touchscreen Keypad with your hand palm to activate the lock before setting it up.

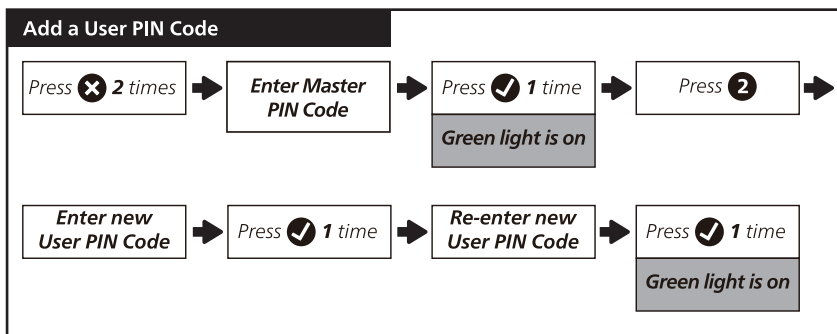
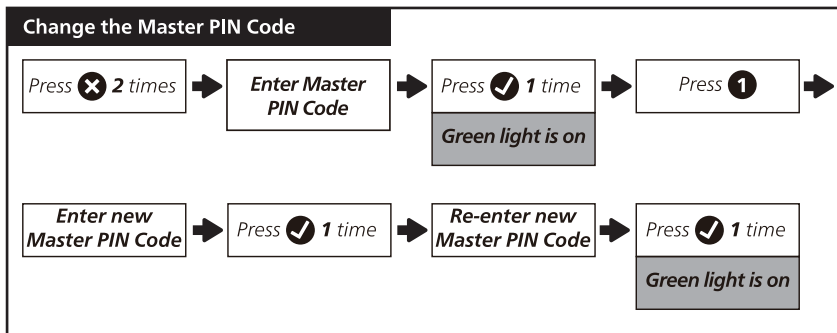
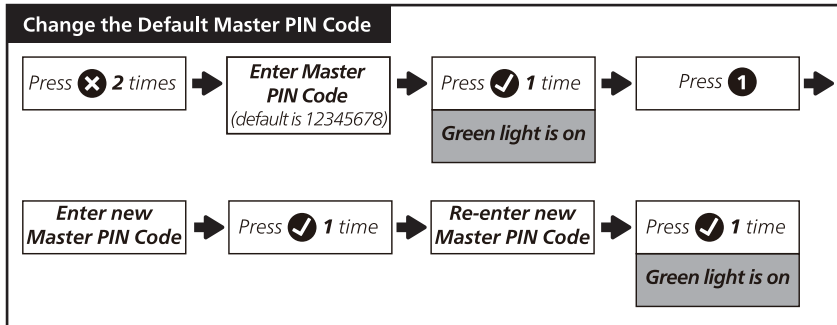

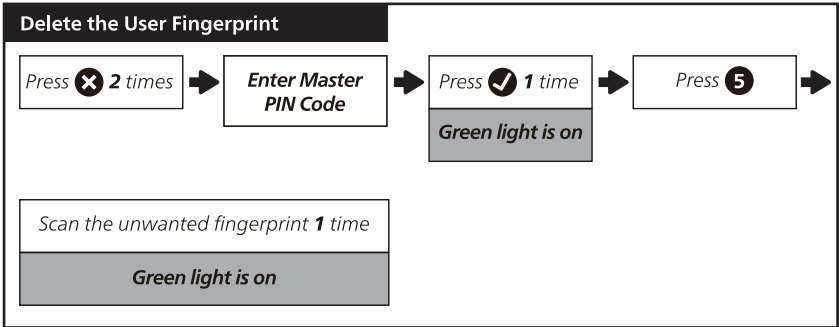
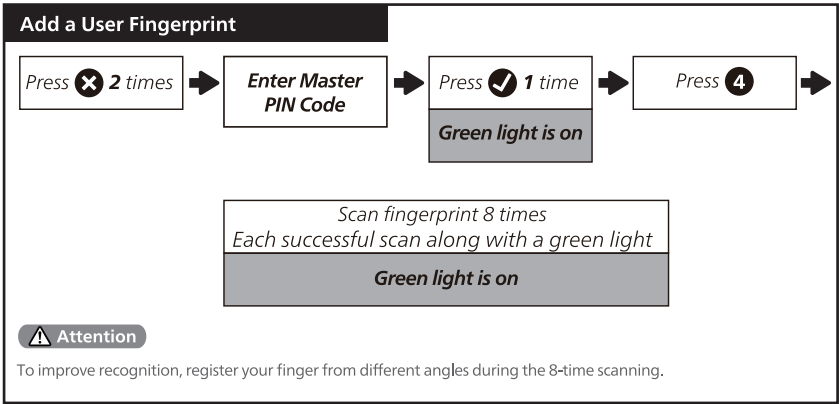
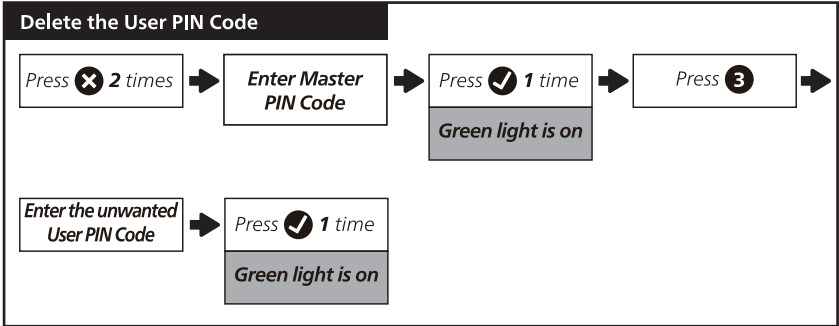

Change the System Language

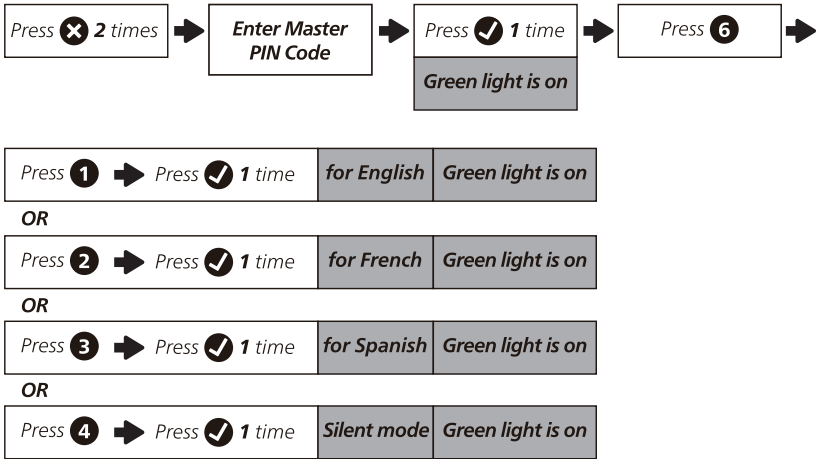

Timed Auto-Lock Setting

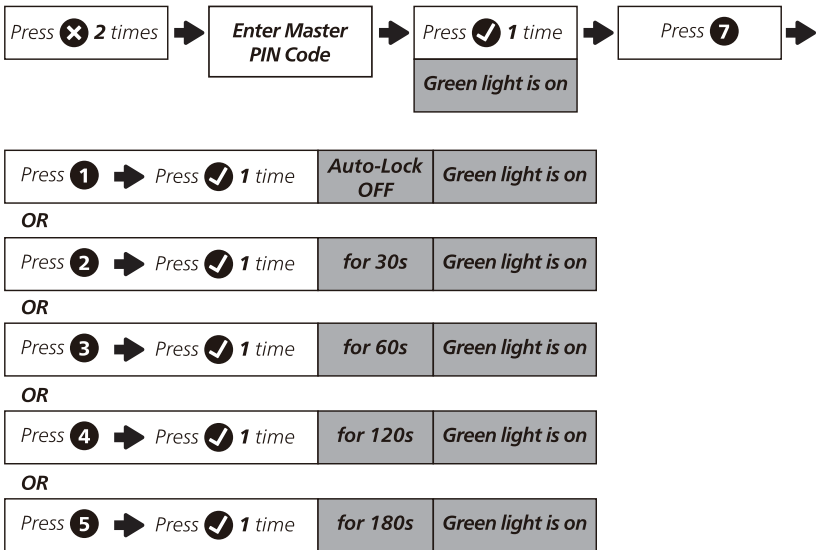

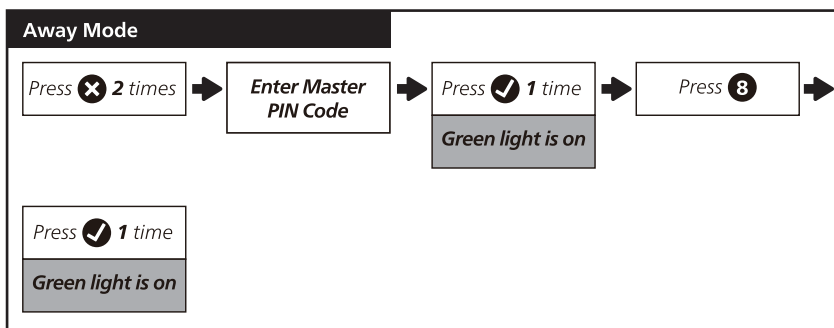

Lock & Unlock

Unlocking the Door from Outside

⚠ Attention

Before entering PIN codes, place your hand on the Touchscreen Keypad to wake it up.

1. Unlock by PIN codes.
2. Unlock by Fingerprint.
3. Unlock by Mechanical Key.

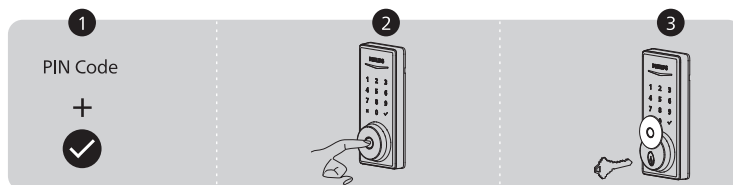

Unlocking the Door from Inside

Rotate the Thumb Turn to unlocked position.

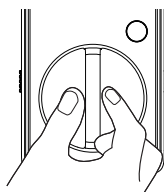

Locking the Door from Outside

1. Press and hold any button on the keypad for at least 2 seconds to lock the door in Manual Mode.
2. In Auto-Lock mode, the Latch Bolt will automatically extend after it is unlocked and the door is shut.
3. Lock by the Mechanical Key.

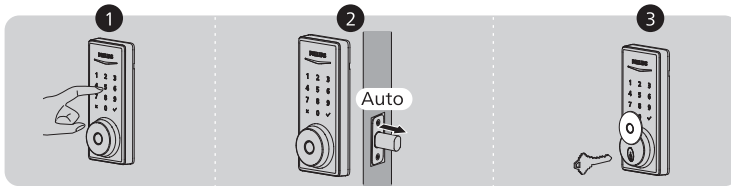

Locking the Door from Inside

1. Rotate the Thumb Turn to the locked position to lock the device in Manual Mode.
2. Press the Privacy Button to lock the device in Manual Mode.
3. In Auto-Lock Mode, the device is locked automatically.

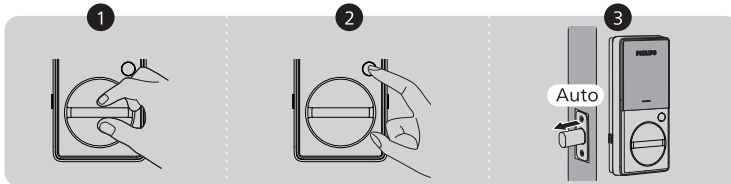

5 Troubleshooting

Issue	Solution
The Latch Bolt does not operate correctly after installation.	<ul style="list-style-type: none"> ◆ Make sure the backset on the Latch Bolt is set to the proper length. Refer to page 8. ◆ Make sure before installation the Latch Bolt is retracted. Refer to page 9. ◆ Please restore to the factory default setting and enter the default Master PIN Code to set up the lock. Refer to page 14.
After installation, the Latch Bolt makes sounds but does not work.	<p>Ensure you have followed the installation instructions. Re-install and reset the lock by paying attention to the following tips:</p> <ul style="list-style-type: none"> ◆ Before installing the Exterior and Interior Assembly, make sure the Latch Bolt is fully retracted (in the unlocked position). ◆ Do not insert the key when you are installing. ◆ Ensure you have inserted the cable connector of the Exterior Assembly to the socket on the Interior Assembly correctly. ◆ Keep the Exterior and Interior Assembly aligned and parallel to the door edge, and the Latch Bolt parallel to the door edge. ◆ Press and hold the Reset Button for at least 5 seconds until you hear a beep. ◆ Use new 4 AA dry batteries, do not use rechargeable batteries, or new batteries mixed with old batteries.
The door handing is not activated after the batteries are installed.	<ul style="list-style-type: none"> ◆ Press the Reset Button for at least 5 seconds until you hear the tone prompting you to restore the default settings.
The lock turns in the wrong direction.	<ul style="list-style-type: none"> ◆ Press and hold the Reset Button for at least 5 seconds until you hear a beep to activate the lock-handing process. ◆ If resetting fails to solve it, the lock is probably not installed correctly. Please re-install the lock and reset it again.
Cannot pull out the key from the Keyhole.	<ul style="list-style-type: none"> ◆ Disassemble the lock, then rotate to pull out the key and re-install the lock. ◆ Do not insert the key when you are installing.
The lock rotates only if the Key is inserted.	<ul style="list-style-type: none"> ◆ Make sure the Latch Bolt is installed correctly. Refer to page 8-9.
The lock does not smoothly lock or unlock while using the Thumb Turn.	<ul style="list-style-type: none"> ◆ Confirm the Mounting Screws are properly installed.

Issue	Solution
<p>The lock only locks but does not unlock, or the Latch Bolt goes in and out uncontrollably.</p>	<ul style="list-style-type: none"> ◆ If the door locks and unlocks smoothly in the open position, then there is a problem with the door frame. Make sure the hole in the door frame is drilled a minimum of 1"(25mm) deep to leave enough space for the deadbolt to extend into the door frame when the door is locked. ◆ If the issue still happens in the open position, then there is a problem with the lock handing or installation. Press and hold the Reset Button for at least 5 seconds until you hear a beep to reset the lock. If resetting fails to solve it, the lock is probably not installed correctly. Please re-install the lock and reset it again. ◆ If the solutions still cannot solve the problem, please feel free to contact us.
<p>Failed to lock.</p>	<ul style="list-style-type: none"> ◆ Keep the Exterior and Interior Assembly aligned and parallel to the door edge. ◆ Keep the Latch Bolt parallel to the door edge.
<p>The Master PIN Code cannot be changed.</p>	<ul style="list-style-type: none"> ◆ Restore factory settings and reprogram all user PIN codes. Refer to page 14-16.
<p>Failed to scan the QR Code on the device.</p>	<ul style="list-style-type: none"> ◆ Scan the QR Code in a well-lit environment, use the built-in flashlight on your phone, or try to scan in an environment with sufficient lighting. ◆ Ensure enough distance between your smartphone and the QR Code, and ensure the QR Code is at the center of your phone screen. ◆ Direct lighting or sunlight can cause reflections that will interfere with the scanning process.
<p>Failed to set up the lock.</p>	<ul style="list-style-type: none"> ◆ Make sure the lock is installed correctly. ◆ Insert fresh batteries and make sure that the cable is not pinched. ◆ After installation, reset the lock to factory settings to complete the lock setting process.
<p>I forgot my Master PIN Code.</p>	<ul style="list-style-type: none"> ◆ Perform a factory reset to clear all PIN codes. Once the reset is completed, all PIN codes will be deleted and the Master PIN Code will be reset to the default Master PIN Code of 12345678.
<p>One-Time PIN Code does not work.</p>	<ul style="list-style-type: none"> ◆ Check if the Master PIN Code you set in the app is the same as the Master PIN Code of the lock. If not, change the Master PIN Code in the Philips Home Access app to the correct one.

Issue	Solution
Cannot add fingerprints, or the fingerprint does not work.	<ul style="list-style-type: none"> ◆ Make sure the fingerprint is registered and recognizable. ◆ Change the default Master PIN Code (12345678) before adding fingerprints. ◆ Keep the finger to be registered dry and clean. ◆ Keep the Fingerprint Sensor dry and clean. ◆ Add multiple fingerprints with the same finger. ◆ Try to add fingerprints of other fingers. ◆ To improve recognition, register your finger from different angles and press harder during the 8-time scanning.
Receiving low battery alerts.	<ul style="list-style-type: none"> ◆ Remove the batteries and insert 4 new AA alkaline batteries.
The keypad is not responding.	<ul style="list-style-type: none"> ◆ Make sure batteries are inserted correctly. ◆ If the battery indicator flashes continuously, the batteries are low. Please replace them with 4 new AA alkaline batteries. ◆ Make sure that the cable is properly connected and has not been damaged during installation.
Auto-Lock is not working.	<ul style="list-style-type: none"> ◆ If the battery indicator flashes continuously, the batteries are low. Please replace them with 4 new AA alkaline batteries. ◆ Activate the Auto-Lock function. Refer to page 18.

Still have questions or need help? Please feel free to contact us:



U.S.A. & Canada: +1(833)599-9111

6 Warranty

2 Years Warranty

For more information on the warranty applicable for this product, please visit www.philips.com or contact the dealer where you purchased the product.



Philips and the Philips Shield Emblem are registered trademarks of Koninklijke Philips N.V. and are used under license. This product has been manufactured by and is sold under the responsibility of Shenzhen Conex Intelligent Technology Co., Ltd. and Shenzhen Conex Intelligent Technology Co., Ltd. is the warrantor concerning this product.