



BUILT-IN ELECTRIC & INDUCTION COOKTOP MANUAL

Ceramic Cooktops:

CR4B30MB/LCR4BK
CR4B30T11B/LCR4BTB
CR5B30T7B/LCR5BTB
CR5B30T8W/LCR5BTW
CR5B36MB/LCR5B36K
CR5B36T9B/LCR5B36TB
CR5B36TXW/LCR5B36TW
CRH2BT30115
CRH2BT30230

Induction Cooktops:

SINC2B230B/LNC2B230B
SINC2B231W/LNC2B231W
SINC4B241B/LNC4B241B
SINC4B242W/LNC4B242W
SINC4B301B/LNC4B301B
SINC4B302W/LNC4B302W
SINC5B36B/LNC5B36B
SINC5B36W/LNC5B36W
SINC2B115/LNC2B115
SINCH115V2B/LNCH115V2B
SINCH230V2B/LNCH230V2B
SINCH115V2BCA
SINC2B115CA

**BEFORE USE, PLEASE READ AND FOLLOW ALL SAFETY
RULES AND OPERATING INSTRUCTIONS IN THIS
MANUAL.**

*Write Serial No. (on back of unit)
here:*

Felix Storch, Inc.
Summit Appliance Division
An ISO 9001:2015 registered company
770 Garrison Avenue Bronx, New York 10474
www.summitappliance.com

TABLE OF CONTENTS

<i>Important Safeguards</i>	3-7
<i>Installation Instructions</i>	8-13
<i>Ceramic Cooktop Layout</i>	14-20
<i>Induction Cooktop Layout</i>	21-29
<i>Operating your Cooktop</i>	34-51
<i>Choosing the Right Cookware</i>	34-35
<i>Using the Touch Controls</i>	36-37
<i>Using the Knob Control Models</i>	37-38
<i>Using the Extended Cooking Zone</i>	38-39
<i>Using the Keep Warm Zone</i>	39
<i>Using the Booster Function</i>	39-40
<i>Child Lock</i>	40
<i>Stop & Go Function</i>	41
<i>Using the Timer</i>	42-44
<i>Residual Heat Warning</i>	44
<i>Auto Shutdown</i>	45
<i>Overheat & Overflow Protection</i>	45
<i>Cooking Guidelines & Heat Settings</i>	45-47
<i>Cleaning and Care</i>	48-49
<i>Troubleshooting</i>	50
<i>Notes</i>	51
<i>Limited Warranty</i>	52

IMPORTANT SAFEGUARDS



Please read all instructions carefully before use.

Your safety is important to us. Please read the information below before installing or using your cooktop.

- Read these instructions carefully before installing or using this appliance.
- No combustible material or products should be placed on this appliance at any time.
- Please make this information available to the person responsible for installing the Cooktop as it could reduce your installation costs.
- In order to avoid a hazard, this appliance must be installed according to these instructions for installation.
- This appliance is to be properly installed and earthed only by a suitably qualified person.
- This appliance should be connected to a circuit which incorporates an isolating switch providing full disconnection from the power supply.
- Failure to install the appliance correctly could invalidate any warranty or liability claims.
- Never leave the appliance unattended when in use. Boil over causes smoking and greasy spillovers that may ignite.
- Never use your appliance as a work or storage surface.
- Never leave any objects or utensils on the appliance.
- Do not place or leave any magnetizable objects (e.g., credit cards, memory cards) or electronic devices (e.g., computers, MP3 players) near the appliance, as they may be affected by its electromagnetic field.
- Make Sure Reflector Pans or Drip Bowls Are in Place – Absence of these pans or bowls during cooking may subject wiring or components underneath to damage.
- Never use your appliance for warming or heating the room.
- After use, always turn off the cooking zones and the cooktop as described in this manual. Do not rely on the pan detection feature to turn off the cooking zones when you remove the pans.

- Do not allow children to play with the appliance or sit, stand, or climb on it.
- Do not store items of interest to children in cabinets above the cooktop. Children climbing on the cooktop could be seriously injured.
- Do not leave children alone or unattended in the area where the appliance is in use. They should never be allowed to sit or stand on any part of the appliance.
- Children or persons with a disability which limits their ability to use the appliance should have a responsible and competent person to instruct them in its use. The instructor should be satisfied that they can use the appliance without danger to themselves or their surroundings.
- Do not repair or replace any part of the appliance unless specifically recommended in the manual. All other servicing should be done by a qualified technician.
- Do not use steam cleaner to clean cooktop.
- Clean Cook-Top with Caution – If a wet sponge or cloth is used to wipe spills on a hot cooking area, be careful to avoid steam burn. Some cleaners can produce noxious fumes if applied to a hot surface.
- Do not place or drop heavy objects on cooktop.
- Do not stand on your cooktop.
- Do not use pans with jagged edges or drag pans across the ceramic glass surface as this can scratch the glass.
- Do not use scourers or any other harsh abrasive cleaning agents to clean your cooktop, as these can scratch the ceramic glass.
- Do Not Use Water on Grease Fires – Smother fire or flame or use dry chemical or foam-type extinguisher.
- Protective Liners – Do not use aluminum foil to line surface unit drip bowls or oven bottoms, except as suggested in the manual. Improper installation of these liners may result in a risk of electric shock, or fire.
- Do Not Soak Removable Heating Elements – Heating elements should never be immersed in water.
- If the power supply cable is damaged, it must only be replaced by qualified technician.
- This appliance is intended to be used in household and similar applications such as: -staff kitchen areas in shops, offices and other

working environments; -farm houses; -by clients in hotels, motels, and other residential type environments; -bed and breakfast type environments.

- Use Proper Pan Size – This appliance is equipped with one or more surface units of different size. Select utensils having flat bottoms large enough to cover the surface unit heating element. The use of undersized utensils will expose a portion of the heating element to direct contact and may result in ignition of clothing. Proper relationship of utensil to burner will also improve efficiency.
- Glazed Cooking Utensils – Only certain types of glass, glass/ceramic, ceramic, earthenware, or other glazed utensils are suitable for range-top service without breaking due to the sudden change in temperature.
- This appliance can be used by children aged from 8 years and above and persons with reduced physical, sensory, or mental capabilities or lack of experience and knowledge if they have been given supervision or instruction concerning use of the appliance in a safe way and understand the hazards involved. Children shall not play with the appliance. Cleaning and user maintenance shall not be made by children without supervision.

IMPORTANT: Save for the local electrical inspector's use.

To eliminate the risk of burns or fire by reaching over heated surface units, cabinet storage space located above the surface units should be avoided. If cabinet storage is to be provided, the risk can be reduced by installing a range hood that projects horizontally a minimum of 5 inches beyond the bottom of the cabinets.

Electrical Shock Hazard

- Disconnect the appliance from the main electricity supply before carrying out any work or maintenance on it.
- Connection to a grounded wiring system is essential and mandatory.
- Alterations to the domestic wiring system must only be made by a qualified electrician.
- Failure to follow this advice may result in electrical shock or death.

- Do not cook on a broken or cracked cooktop. If the cooktop surface should break or crack, switch the appliance off immediately at the main power supply (wall switch) and contact a qualified technician.
- Switch the cooktop off at the wall before cleaning or maintenance.
- Failure to follow this advice may result in electrical shock or death.

Hot Surface Hazard

- During use, accessible parts of this appliance will become hot enough to cause burns.
- **DO NOT TOUCH SURFACE UNITS OR AREAS NEAR UNITS** – Surface units may be hot even though they are dark in color. Areas near surface units may become hot enough to cause burns. During and after use, do not touch, or let clothing or other flammable materials contact surface units or areas near units until they have had sufficient time to cool. Among these areas are (identification of areas – for example, the cook-top and surfaces facing the cook-top).
- Do not let your body, clothing, or any item other than suitable cookware contact the ceramic glass until the surface is cool.
- **Wear Proper Apparel** – Loose-fitting or hanging garments should never be worn while using the appliance.
- **Beware:** Metallic objects such as knives, forks, spoons, and lids should not be placed on the cooktop surface, since they can get hot.
- **Storage in or on Appliance** – Flammable materials should not be stored or near surface units.
- **Keep children away.**
- **Handles of saucepans may be hot to touch.** Check saucepan handles do not overhang other cooking zones that are on. Keep handles out of reach of children.
- **Utensil Handles Should Be Turned Inward and Not Extend Over Adjacent Surface Units.** To reduce the risk of burns, ignition of flammable materials, and spillage due to unintentional contact with the utensil, the handle of a utensil should be positioned so that it is turned inward and does not extend over adjacent surface units.
- Failure to follow this advice could result in burns and scalds.

Cut Hazard

- Take care: panel edges are sharp.
- Failure to use caution could result in injury or cuts.
- The razor-sharp blade of a cooktop scraper is exposed when the safety cover is retracted. Use with extreme care and always store safely and out of reach of children.
- Failure to use caution could result in injury or cuts.

Health Hazard

- This appliance complies with electromagnetic safety standards.
- However, persons with cardiac pacemakers or other electrical implants (such as insulin pumps) must consult with their doctor or implant manufacturer before using this appliance to make sure that their implants will not be affected by the electromagnetic field.
- Failure to follow this advice may result in death.

WARNING: Unattended cooking on a cooktop with fat or oil can be dangerous and may result in fire. NEVER try to extinguish a fire with water but switch off the appliance and then cover flame e.g., with a lid or a fire blanket.

-SAVE THESE INSTRUCTIONS-

INSTALLATION INSTRUCTIONS

The cooktop must be installed and connected in accordance with all local codes and regulations.

After unpacking the appliance, ensure there is no visible damage. If it has been damaged during transit, DO NOT USE. Contact your appliance seller immediately.

Cooktop Installation

- Cut out the work surface according to the sizes shown on the table in the next page.
- For the purpose of installation and use, keep a minimum of 5cm/2" space around the cutout free and clear.
- Be sure the thickness of the work surface is at least 30mm/1.2". Select heat-resistant work surface material to avoid surface deformation caused by the heat radiating off of the hotplate.

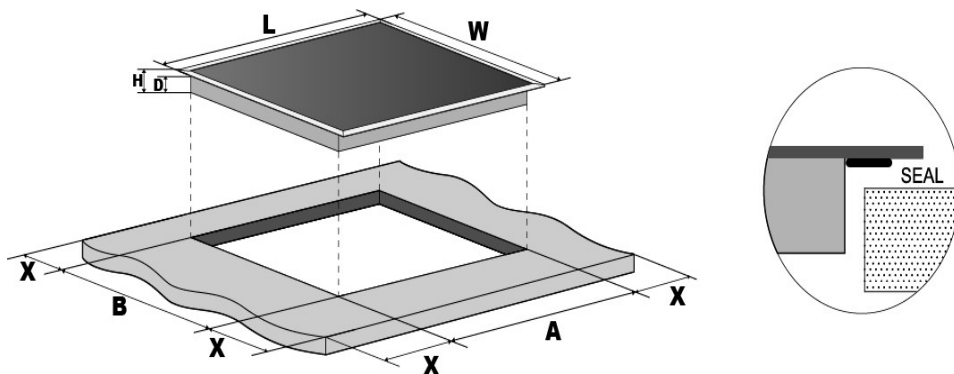

Measurements in the table below are shown in inches (“):

Model	L	W	H	D	A	B	X
SINC2B115/LNC2B115 SINC2B230B/LNC2B230B SINC2B231W/LNC2B231W SINCH115V2B/LNCH115V2B SINCH230V2B/LNCH230V2B SINCH115V2BCA SINC2B115CA	11.3	20.5	2.2	2.1	10.4+ 0.2 -0	19.5+ 0.2 -0	2.0 min
SINC4B241B/LNC4B241B SINC4B242W/LNC4B242W	23.2	20.5	2.2	2.1	21.9+ 0.2 -0	19.5+ 0.2 -0	2.0 min
SINC4B301B/LNC4B301B SINC4B302W/LNC4B302W	30.3	20.5	2.2	2.1	29.3+ 0.2 -0	19.5+ 0.2 -0	2.0 min
CR4B30T11B/LCR4BTB CR4B30MB/LCR4BK CR5B30T7B/LCR5BTB CR5B30T8W/LCR5BTW	30.3	20.5	2.1	1.9	29.3+ 0.2 -0	19.5+ 0.2 -0	2.0 min
SINC5B36B/LNC5B36B SINC5B36W/LNC5B36W	35.4	20.5	2.2	2.1	34.5+ 0.2 -0	19.5+ 0.2 -0	2.0 min
CR5B36MB/LCR5B36K CR5B36T9B/LCR5B36TB CR5B36TXW/LCR5B36TW	35.4	20.5	2.1	1.9	34.5+ 0.2 -0	19.5+ 0.2 -0	2.0 min
CRH2BT30115 CRH2BT30230	11.3	20.5	2.2	2.1	10.4+ 0.2 -0	19.5+ 0.2 -0	2.0 min

Make sure the electric cooktop is well ventilated and the air inlet and outlet are not blocked. Ensure the electric cooktop is in good work state. As shown below:



Note: The safety distance between the hotplate and the cupboard above the hotplate should be at least 760mm (30”).

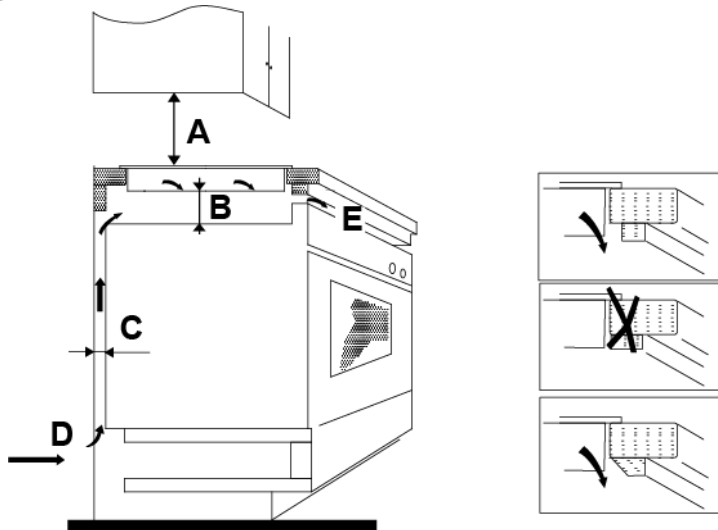

A	B	C	D	E
760mm/ 30"	50mm minimal/ 2"	20mm minimal/ .78"	Air intake	Air exit 5mm/ .2"

Installing the Foam Gasket

Before inserting the cooktop into the kitchen cutout, the supplied foam gasket (in a plastic bag) must be attached to the lower side of the ceramic glass.

CAUTION: DO NOT install the cooktop without the foam gasket.

To install the foam gasket, follow these steps:

1. Remove the protective film from the gasket.
2. Attach the gasket to the lower side of the glass, next to the edge.

3. The gasket must be attached along the entire length of the glass edge and should not overlap at the corners.
4. When installing the gasket, make sure that the glass does not come into contact with any sharp objects.

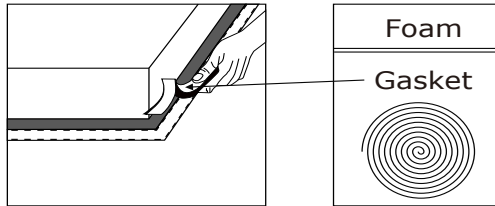

Before Installing the Fixing Brackets

- The unit should be placed on a stable, smooth surface (use the packaging). Do not apply force onto the controls protruding from the cooktop.
- There is one Easy Fit kit package for each cooktop, including fixing clips and screws.

1. **Fix the clips to the cooktop:** Insert the fixing clips into the fixing holes, located on the sides of the cooktop housing. Then, secure each clip to the housing with a screw.

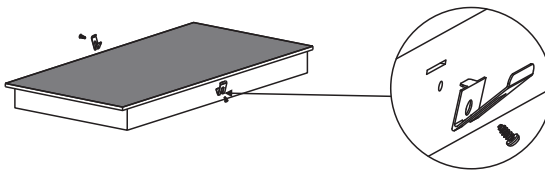

2. **Fix the cooktop to the cabinet:** Insert the cooktop into the kitchen cutout, as shown in the diagram below. The mounted clips on each side will secure your cooktop.

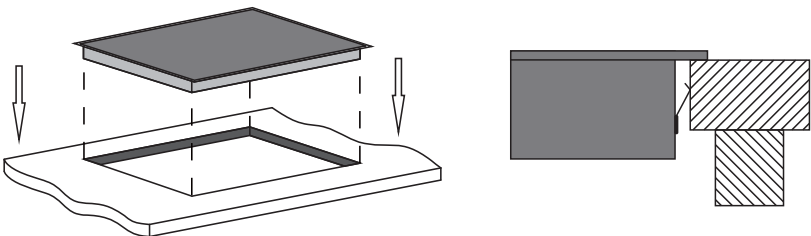

Connecting the Cooktop to the Power Supply

The power supply should be connected in compliance with National Electric Codes, as well as all state, municipal, and local codes. The supply must be from an individual grounded circuit that is protected by a circuit breaker.

CAUTION: The appliance has a large power rating and must be connected to electricity by a Qualified Electrician.

Notes:

- If the power cable is damaged or needs replacing, this should be done by a technician using the proper tools, to avoid any accidents.
- If the appliance is being connected directly to the main power supply, an omni polar circuit breaker must be installed with a minimum gap of 3mm between the contacts.
- The installer must ensure that the correct electrical connection has been made and that it complies with the proper local safety regulations.
- The power cable must not be bent or compressed.
- The power cable must be checked regularly and only replaced by qualified technician.

Cautions:

1. The cooktop must be installed by qualified personnel or technicians. Do not attempt to install the cooktop yourself.
2. The electric cooktop shall not be mounted to cooling equipment, dishwashers, or rotary dryers.
3. The electric cooktop shall be installed such that better heat radiation can be ensured to enhance its reliability.
4. Be sure the wall and the area above the cooktop are able to withstand any residual heat created through use.
5. To avoid any damage, the sandwich layer and adhesive must be heat resistant.
6. A steam cleaner is not to be used.

7. This electric cooktop can be connected only to a supply with system impedance no more than 0.427 ohm. If necessary, contact your power supply company for system impedance information.

NOTE: For models is supplied with a power cord and plug. You can directly plug the unit into the socket, please keep the power cord plug out after use.

SINC2B115/ LNC2B115 SINCH115V2BCA SINC2B115CA	AC 120V~ 60Hz 1800W
--	------------------------

SINCH115V2B/ LN CH115V2B	AC 120V~ 60Hz 1800W
-----------------------------	------------------------

For models without plug, the method of connection is shown here:

CR4B30MB/ LCR4BK	AC 240V~ 60Hz 6700W
CR4B30T11B/ LCR4BTB	AC 240V~ 60Hz 6700W
CR5B30T7B/ LCR5BTB	AC 240V~ 60Hz 7200W
CR5B30T8W/ LCR5BTW	AC 240V~ 60Hz 7200W
CR5B36MB/ LCR5B36K	AC 240V~ 60Hz 7700W
CR5B36T9B/ LCR5B36TB	AC 240V~ 60Hz 7700W
CR5B36TXW/ LCR5B36TW	AC 240V~ 60Hz 7700W
SINC2B230B/ LNC2B230B SINCH230V2B/ LNCH230V2B	AC 240V~ 60Hz 3600W
SINC2B231W/ LNC2B231W	AC 240V~ 60Hz 3500W
SINC4B241B /LNC4B241B	AC 240V~ 60Hz 7200W
SINC4B242W/ LNC4B242W	AC 240V~ 60Hz 7000W
SINC4B301B/ LNC4B301B	AC 240V~ 60Hz 7200W

SINC4B302W/ LNC4B302W	AC 240V~ 60Hz 7000W
SINC5B36B/ LNC5B36B	AC 240V~ 60Hz 10200W
SINC5B36W/ LNC5B36W	AC 240V~ 60Hz 9300W
CRH2BT30115	AC 120V~ 60Hz 2400W
CRH2BT30230	AC 240V~ 60Hz 3000W

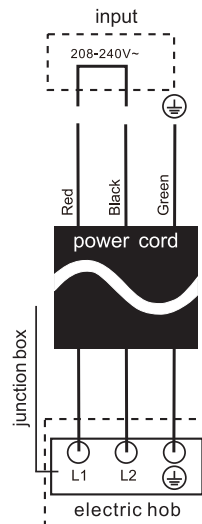

CERAMIC COOKTOP LAYOUT

NOTE: Before your first use, remove any protective film that may still be on your cooktop.

Model: CRH2BT30115

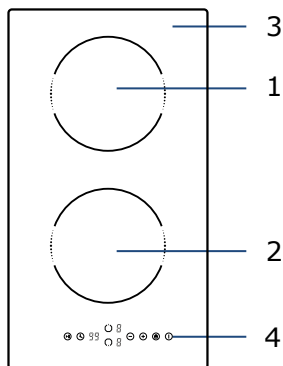

1. 1200W Cooking Zone
2. 1200W Cooking Zone
3. Glass plate
4. Control panel

Control Panel

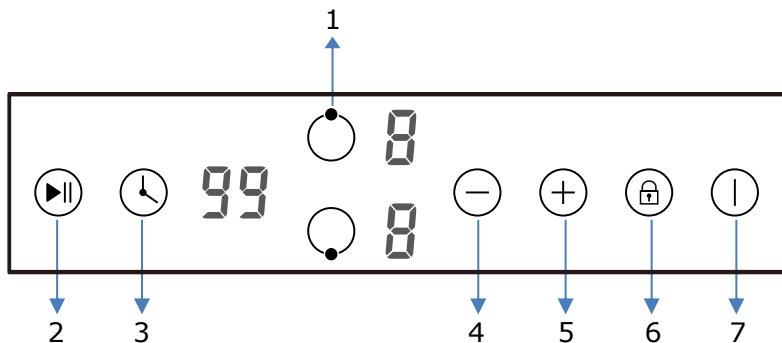

1. Cooking Zone selection button
2. Stop & Go control button
3. Timer control button
4. Heating level/Timer “-” button
5. Heating level/Timer “+” button
6. Child Lock control button
7. ON/OFF button

Model: CRH2BT30230

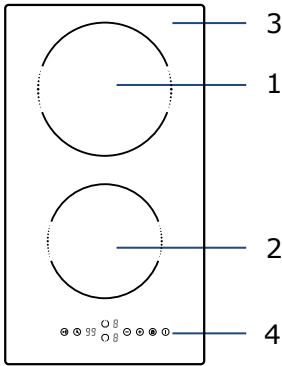

1. 1800W Cooking Zone
2. 1200W Cooking Zone
3. Glass plate
4. Control panel

Control Panel

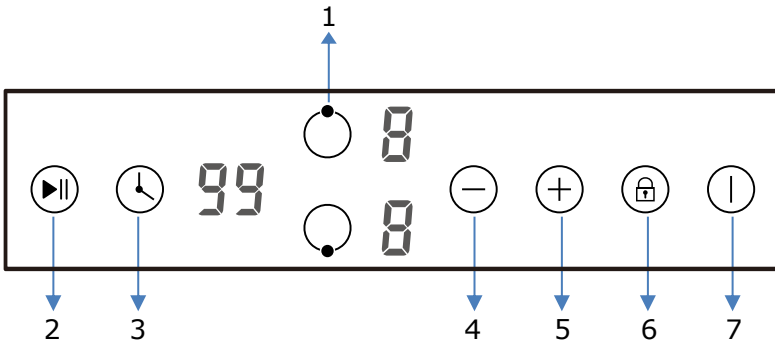

1. Cooking Zone selection button
2. Stop & Go control button
3. Timer control button
4. Heating level/Timer "-" button
5. Heating level/Timer "+" button
6. Child Lock control button
7. ON/OFF button

Model: CR4B30T11B/LCR4BTB

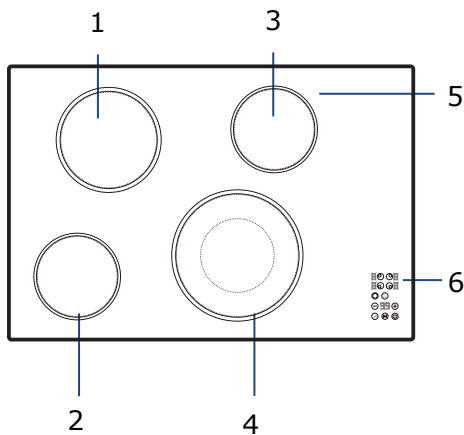

1. 1800W Cooking Zone
2. 1200W Cooking Zone
3. 1200W Cooking Zone
4. 2500/1200W Cooking Zone
5. Glass plate
6. Control panel

Control Panel

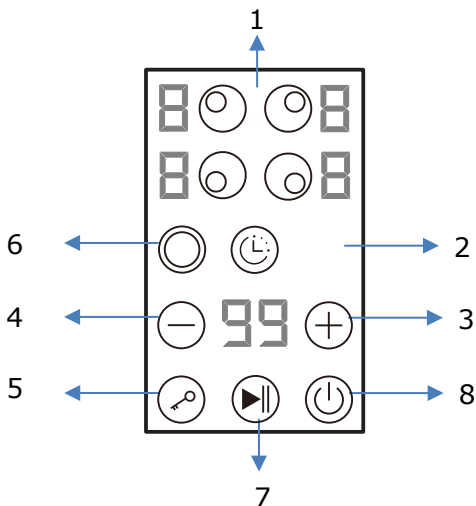

1. Cooking Zone selection button
2. Timer control button
3. Heating level/Timer "+" button
4. Heating level/Timer "-" button
5. Child Lock control button
6. Extended zone control button
7. Stop & Go control button
8. ON/OFF button

Model: CR4B30MB/LCR4BK

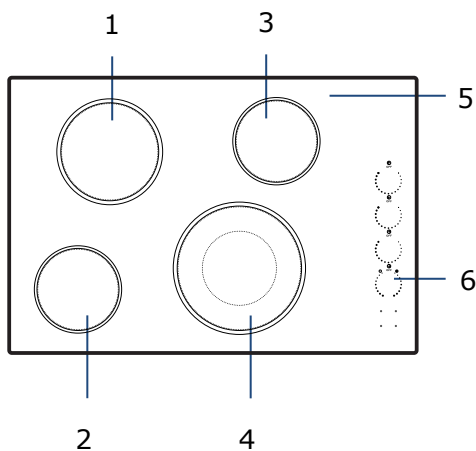

- 1. 1800W Cooking Zone
- 2. 1200W Cooking Zone
- 3. 1200W Cooking Zone
- 4. 2500/1200W Cooking Zone
- 5. Glass plate
- 6. Control panel

Control Panel

- 1. Cooking Zone control knob
- 2. Residual Heat warning indicator

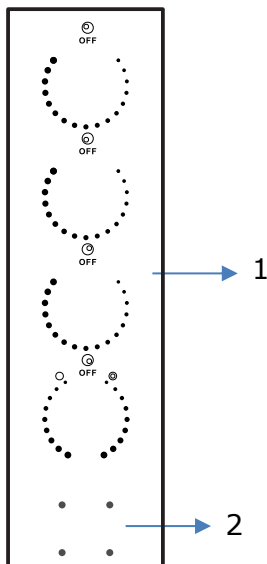

**Model: CR5B30T7B/LCR5BTB
CR5B30T8W/ LCR5BTW**

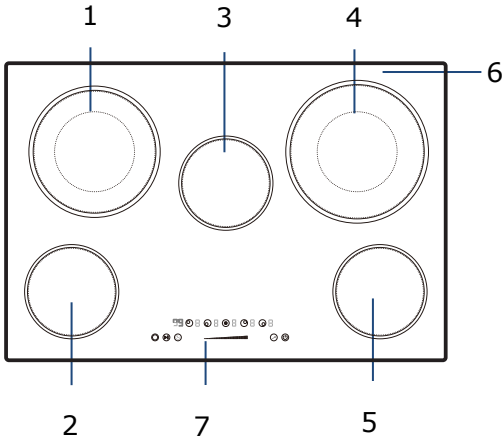

1. 2200/1000W Cooking Zone
2. 1200W Cooking Zone
3. 100W Warming Zone
4. 2500/1200W Cooking Zone
5. 1200W Cooking Zone
6. Glass plate
7. Control Panel
6. Control panel

Control Panel

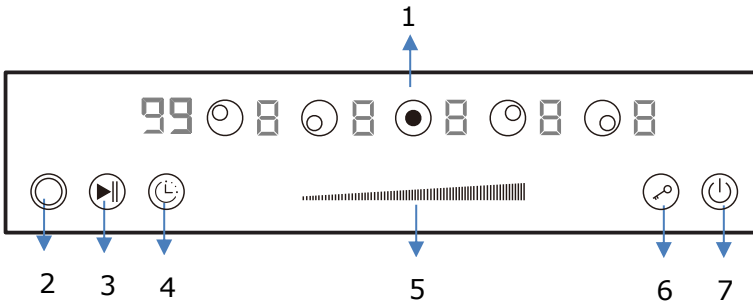

1. Cooking Zone selection button
2. Extended zone control button
3. Stop & Go control button
4. Timer control button
5. Heating level/Timer slider control
6. Child Lock control button
7. ON/OFF button

Model: CR5B36MB/LCR5B36K

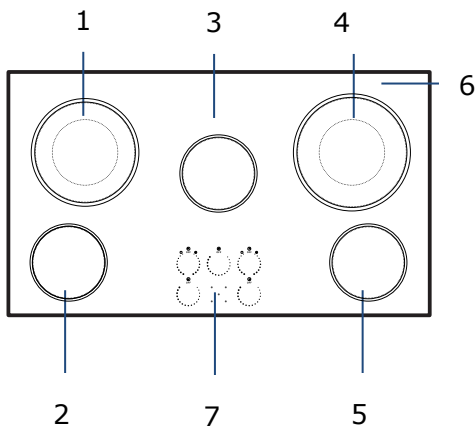

1. 2200/1000W Cooking Zone
2. 1200W Cooking Zone
3. 100W Warming Zone
4. 3000/1600W Cooking Zone 1200W
5. Cooking Zone
6. Glass plate
7. Control Panel

Control Panel

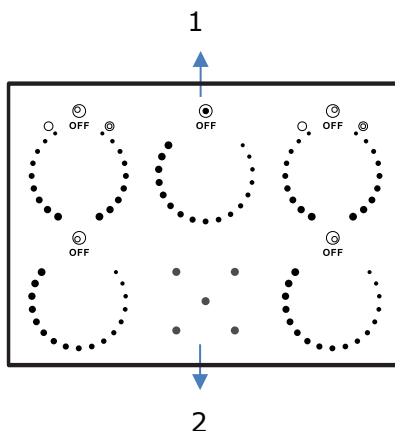

1. Cooking Zone control knob
2. Residual Heat warning indicator

**Model: CR5B36T9B/LCR5B36TB
CR5B36TXW/ LCR5B36TW**

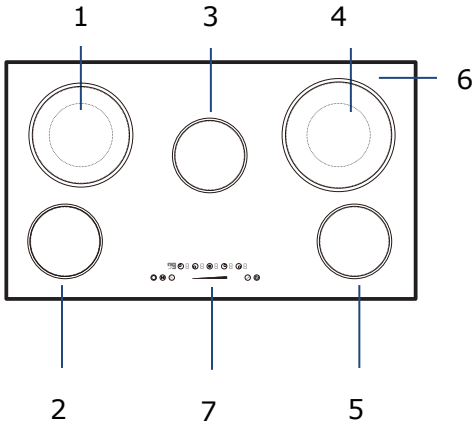

1. 2200/1000W Cooking Zone
2. 1200W Cooking Zone
3. 100W Warming Zone
4. 3000/1600W Cooking Zone
5. 1200W Cooking Zone
6. Glass plate
7. Control Panel

Control Panel

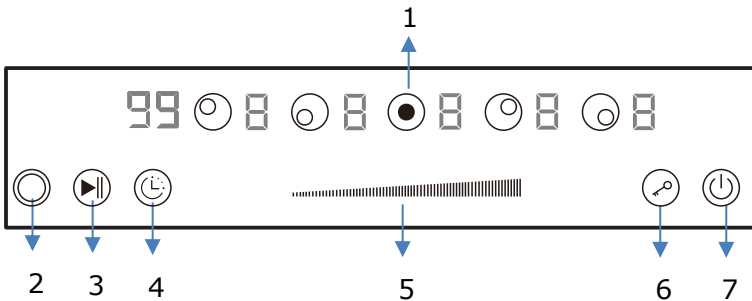

1. Cooking Zone selection button
2. Extended zone control button
3. Stop & Go control button
4. Timer control button
5. Heating level/Timer slider control
6. Child Lock control button
7. ON/OFF button

INDUCTION COOKTOP LAYOUT

Model: SINC2B230B/LNC2B230B

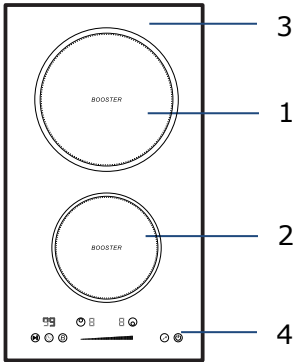

1. 2000W Boost 2600W Cooking Zone
2. 1500W Boost 2000W Cooking Zone
3. Glass plate
4. Control panel

Control Panel

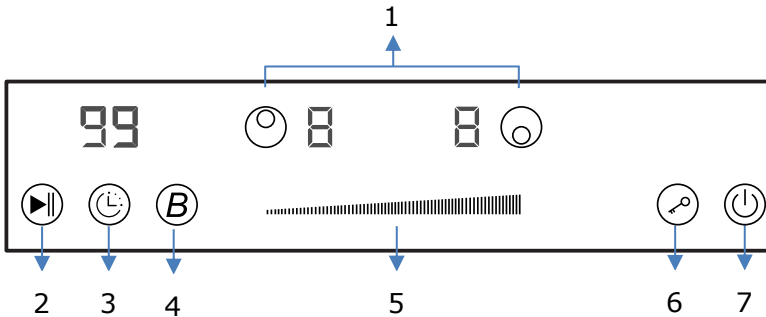

1. Cooking Zone selection button
2. Stop & Go control button
3. Timer control button
4. Booster function control button
5. Heating level/Timer slider control
6. Child Lock control button
7. ON/OFF button

Model: SINC2B231W/LNC2B231W

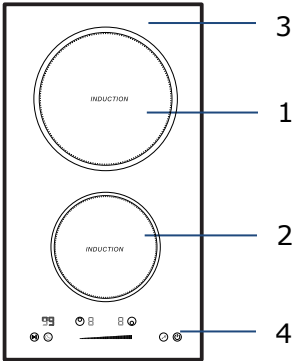

1. 2000W Cooking Zone
2. 1500W Cooking Zone
3. Glass plate
4. Control panel

Control Panel

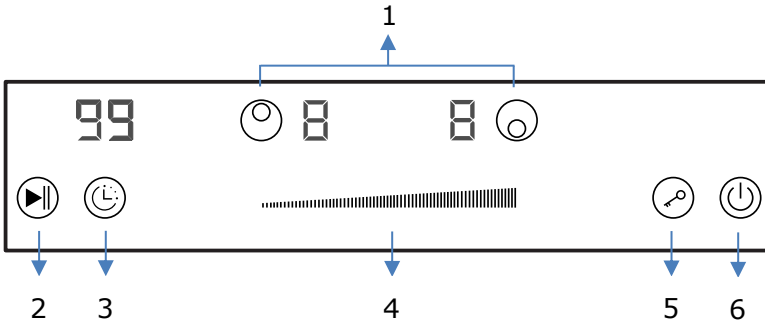

1. Cooking Zone selection button
2. Stop & Go control button
3. Timer control button
4. Heating level/Timer slider control
5. Child Lock control button
6. ON/OFF button

Model: SINC4B241B/LNC4B241B

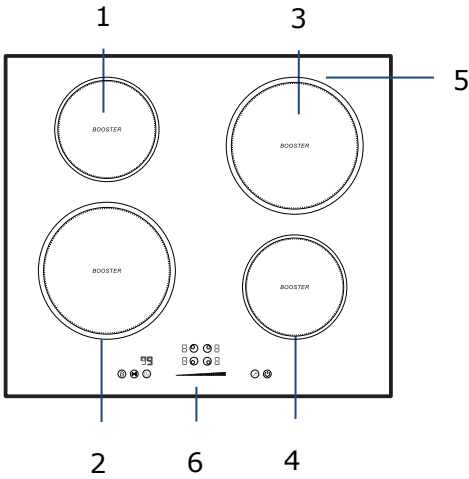

1. 1500W Boost 2000W Cooking Zone
2. 2000W Boost 3000W Cooking Zone
3. 2000W Boost 3000W Cooking Zone
4. 1500W Boost 2000W Cooking Zone
5. Glass plate
6. Control panel

Control Panel

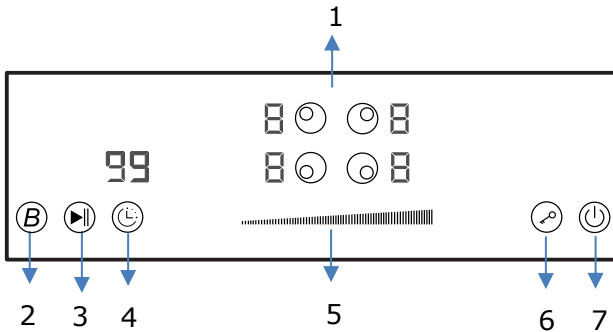

1. Cooking Zone selection button
2. Booster function control button
3. Stop & Go control button
4. Timer control button
5. Heating level/Timer Slider control
6. Child Lock control button
7. ON/OFF button

Model: SINC4B242W/LNC4B242W

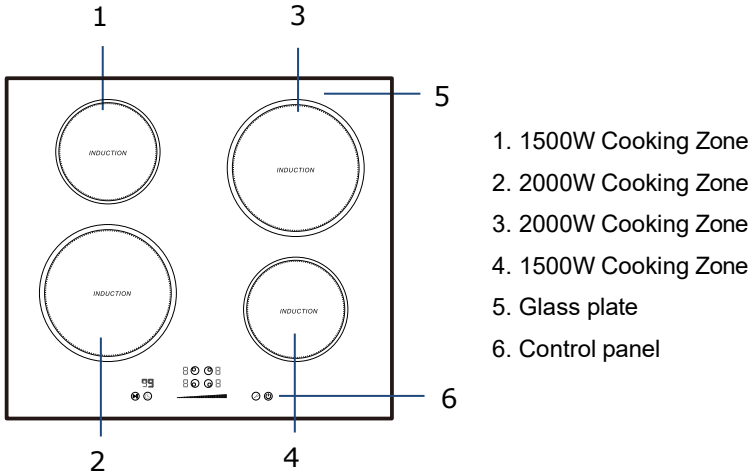

Control Panel

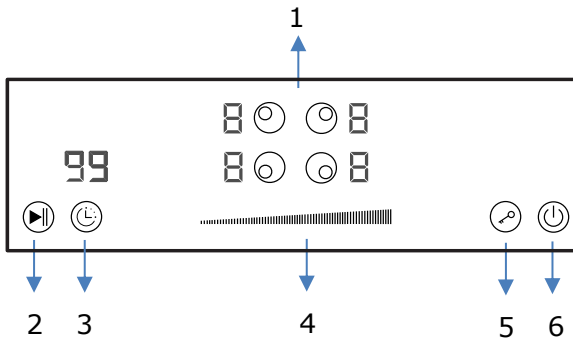

1. Cooking Zone selection button
2. Stop & Go control button
3. Timer control button
4. Heating level/Timer Slider control
5. Child Lock control button
6. ON/OFF button

Model: SINC4B301B/LNC4B301B

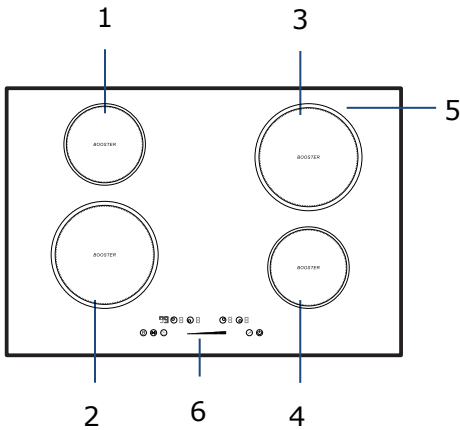

1. 1500W Boost 2000W Cooking Zone
2. 2000W Boost 3000W Cooking Zone
3. 2000W Boost 3000W Cooking Zone
4. 1500W Boost 2000W Cooking Zone
5. Glass plate
6. Control panel

Control Panel

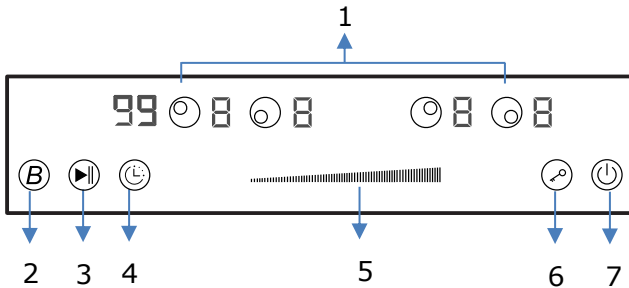

1. Cooking Zone selection button
2. Booster function control button
3. Stop & Go control button
4. Timer control button
5. Heating level/Timer Slider control
6. Child Lock control button
7. ON/OFF button

Model: SINC4B302W/LNC4B302W

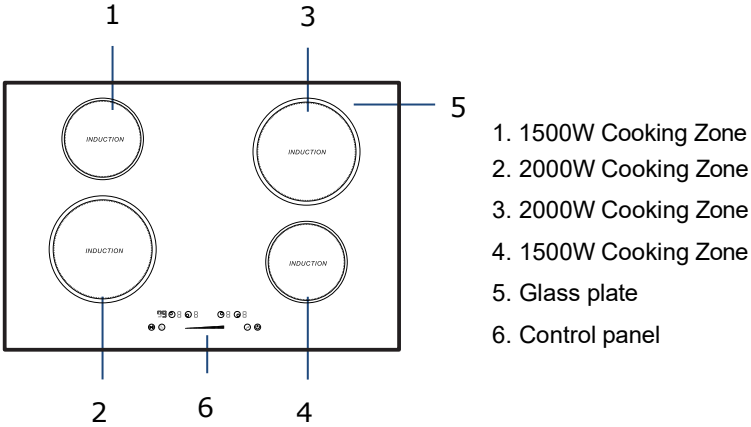

Control Panel

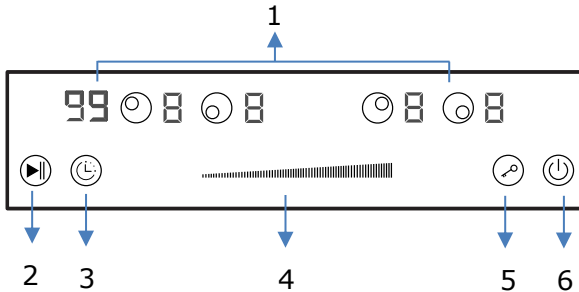

1. Cooking Zone selection button
2. Stop & Go control button
3. Timer control button
4. Heating level/Timer Slider control
5. Child Lock control button
6. ON/OFF button

Model: SINC5B36B/LNC5B36B

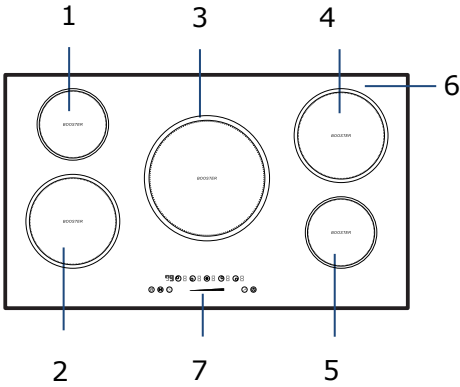

1. 1500W Boost 2000W Cooking Zone
2. 2000W Boost 3000W Cooking Zone
3. 2300W Boost 3000W Cooking Zone
4. 2000W Boost 3000W Cooking Zone
5. 1500W Boost 2000W Cooking Zone
6. Glass plate
7. Control panel

Control Panel

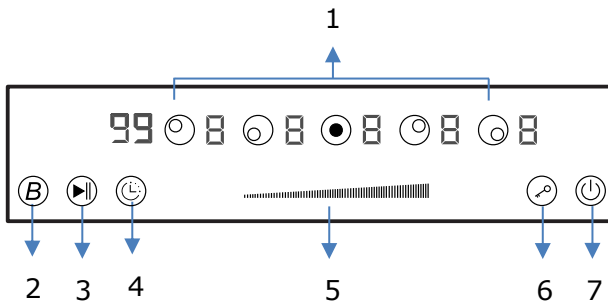

1. Cooking Zone selection button
2. Booster function control button
3. Stop & Go control button
4. Timer control button
5. Heating level/Timer slider control
6. Child Lock control button
7. ON/OFF button

Model: SINC5B36W/LNC5B36W

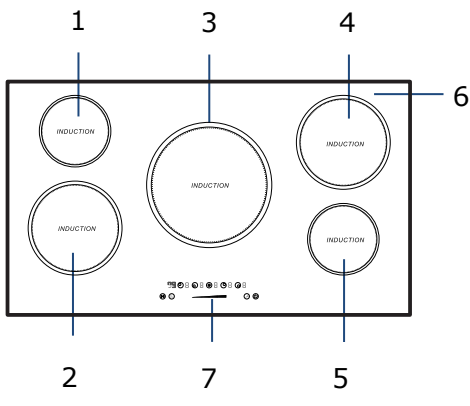

Control Panel

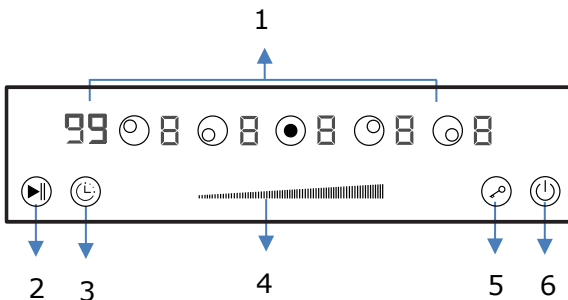

1. Cooking Zone selection button
2. Stop & Go control button
3. Timer control button
4. Heating level/Timer slider control
5. Child Lock control button
6. ON/OFF button

Model: SINC2B115/LNC2B115

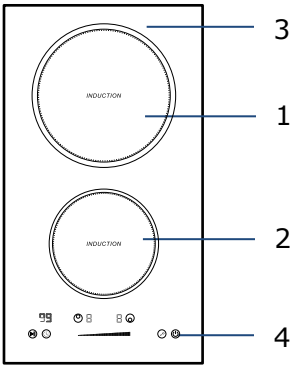

1. 1800W Cooking Zone
2. 1300W Cooking Zone
3. Glass plate
4. Control panel

Control Panel

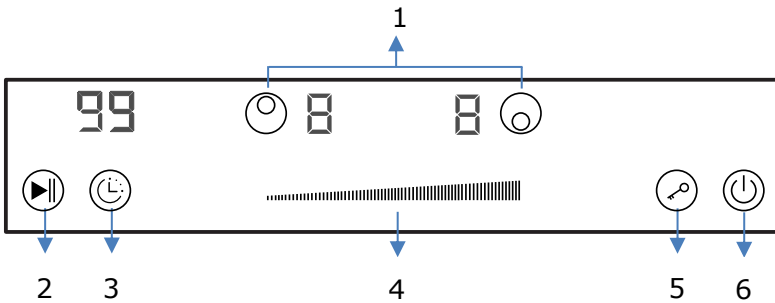

1. Cooking Zone selection button
2. Stop & Go control button
3. Timer control button
4. Heating level/Timer slider control
5. Child Lock control button
6. ON/OFF button

Notes: Specifications are subject to change without notice.

Model: SINCH115V2B/LNCH115V2B

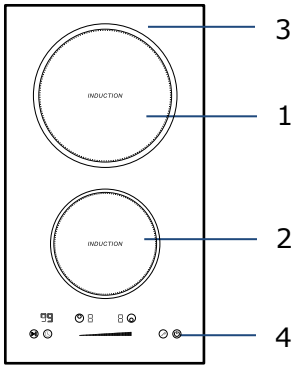

1. 1800W Cooking Zone
2. 1300W Cooking Zone
3. Glass plate
4. Control panel

Control Panel

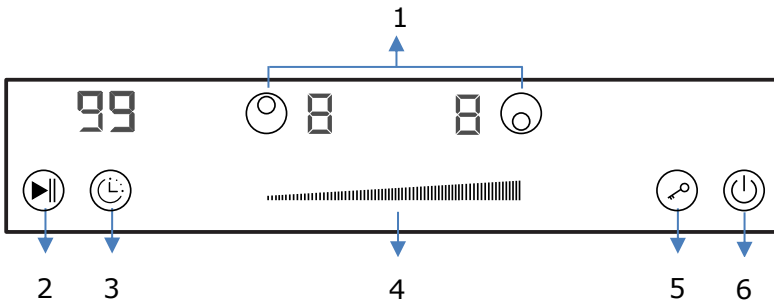

1. Cooking Zone selection button
2. Stop & Go control button
3. Timer control button
4. Heating level/Timer slider control
5. Child Lock control button
6. ON/OFF button

Notes: Specifications are subject to change without notice.

Model: SINCH230V2B/LNCH230V2B

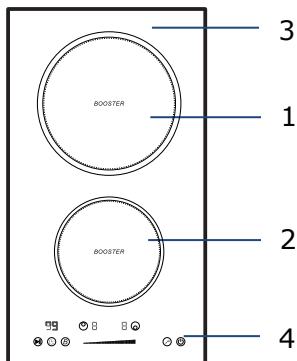

1. 2000W Boost 2600W Cooking Zone
2. 1500W Boost 2000W Cooking Zone
3. Glass plate
4. Control panel

Control Panel

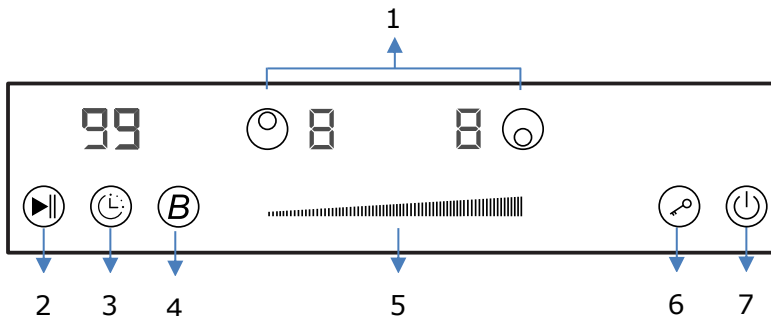

1. Cooking Zone selection button
2. Stop & Go control button
3. Timer control button
4. Booster function control button
5. Heating level/Timer slider control
6. Child Lock control button
7. ON/OFF button

Model: SINCH115V2BCA

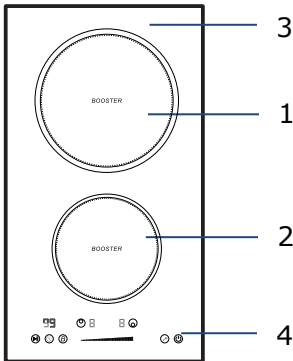

1. 2000W Boost 2600W Cooking Zone
2. 1500W Boost 2000W Cooking Zone
3. Glass plate
4. Control panel

Control Panel

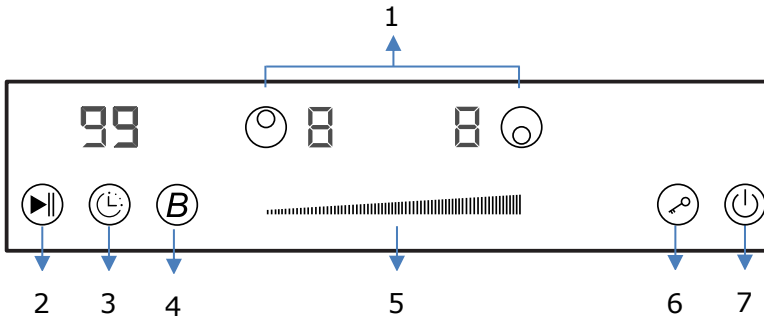

1. Cooking Zone selection button
2. Stop & Go control button
3. Timer control button
4. Booster function control button
5. Heating level/Timer slider control
6. Child Lock control button
7. ON/OFF button

Model: SINC2B115CA

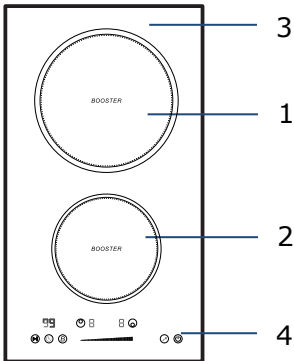

1. 2000W Boost 2600W Cooking Zone
2. 1500W Boost 2000W Cooking Zone
3. Glass plate
4. Control panel

Control Panel

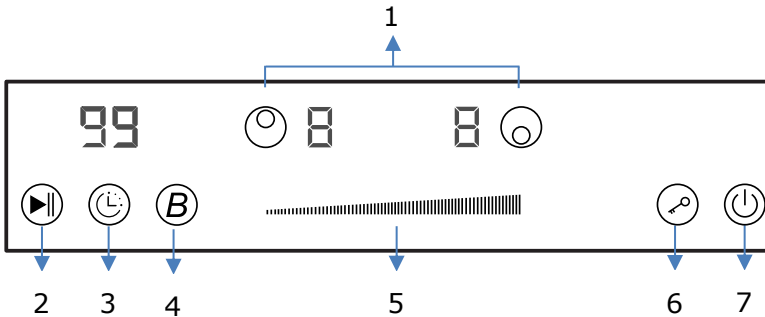

1. Cooking Zone selection button
2. Stop & Go control button
3. Timer control button
4. Booster function control button
5. Heating level/Timer slider control
6. Child Lock control button
7. ON/OFF button

OPERATING YOUR COOKTOP

Choose the Right Cookware (Induction Models)

- Only use cookware with a base suitable for induction cooking. Look for the induction symbol on the packaging or on the bottom of the pan.
- You can check whether your cookware is suitable by carrying out a magnet test. Move a magnet towards the base of the pan. If it is attracted, the pan is suitable for induction hob.
- If you do not have a magnet:
 1. Put some water in the pan you want to check.
 2. If  does not flash in the display and water is heating, the pan is suitable.
- Cookware made from the following materials is not suitable for an induction cooktop: pure stainless steel, aluminum or copper without a magnetic base, glass, wood, porcelain, ceramic, and earthenware.
- Induction cooktops are made from smooth, ceramic glass, the heat comes from a magnetic induction coil which heats the cookware but not the cooking surface. The heat from the cookware is transferred to the food.
- It's important that you use only metal pans specifically designed and/or approved for use on induction hobs. Never allow melamine or plastic containers to come in contact with the heat zones.
- A pan which diameter less than 140mm may not be detected by the induction hob.



Do not use cookware with jagged edges or a curved base.



Make sure that the base of your pan is smooth, sits flat against the glass, and is the same size as the cooking zone. If you use smaller pot efficiency could be less than expected. Always center your pan on the cooking zone.

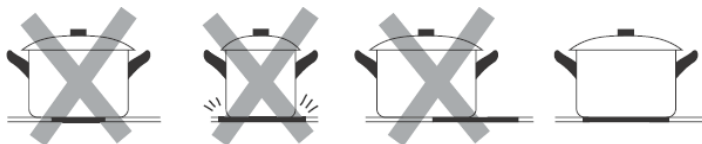

Always lift pans off the hob – do not slide, or they may scratch the glass.

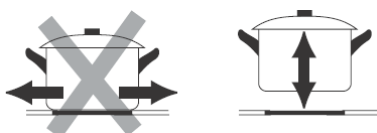

Note: You can use any kind of pot or pan for Ceramic Hobs.

Suggested Pan dimensions for induction hob

The cooking zones are, up to a limit, automatically adapted to the diameter of the pan. However, the bottom of this pan is suggested to have a minimum of diameter according to the corresponding cooking zone. To obtain the best efficiency of your hob, please place the pan in the center of the cooking zone.

Base diameter of the pots:

<i>Cooking zone (in.)</i>	<i>Minimum (in.)</i>	<i>Maximum (in.)</i>
6.3	5.5	6.3
7.1	5.5	7.1
8.3	6.3	8.3
11.0	9.1	11.0

Using the Touch Controls

- The controls respond to touch, so you don't need to apply any pressure. Use the ball of your finger, not its tip.
- You will hear a beep each time a touch is registered.
- Make sure the controls are always clean, dry, and that there is no object (e.g., a utensil or a cloth) covering them. Even a thin film of water may make the controls difficult to operate.

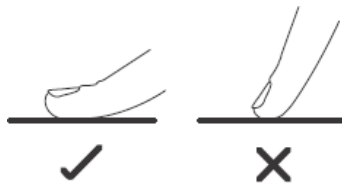

For Touch/Slider Control Models

To Start Cooking

After the cooktop is connected to a power source, the cooktop will beep once, all the indicator lights will illuminate for one second, then go out. To then start cooking, follow these steps:

1. Press and hold the ON/OFF ① control button for about 3 seconds till you hear a “beep” to turn the cooktop on. Now the cooktop enters Standby mode. All of the heat setting indicators and the timer setting indicator shows “-”.
2. Place a suitable pan on the cooking zone you wish to use. Make sure the bottom of the pan and the surface of the cooking zone are clean and dry.
3. Set heating level of cooking zone:
 - a. Before adjusting the heating level, touch the heating zone selection control button to select and activate the cooking zone you wish to use.
 - b. The heat setting indicator of the selected zone will flash when it is active.
 - c. Adjust its heat level by touching the ⊖ or ⊕ button to decrease or increase the heat, respectively. The heat level will cycle from 0 to 9.
 - d. If you have a slider control model, use the slider control in increase/decrease as shown below:

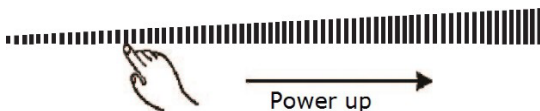

NOTES:

1. When the cooktop is in Standby mode, and no button is pressed for one minute, the cooktop will beep once, then automatically turn off.
2. The default power level setting is level 5.
3. The heat setting indicator of the selected zone will flash when the level is being adjusted or set.
4. After adjusting, the heat setting number will flash for 5 seconds then stop flashing. At this time, the setting will be confirmed.

To Turn Off the Cooktop

1. You can turn the cooking zone off by adjusting heat setting to level 0; the indicator shows “ - “
2. You can also turn the whole cooktop off by touching the ON/OFF ⓘ control button.

NOTES:

- If the power shuts off during cooking, all temperature settings will be cancelled.
- The cooling fan of the induction cooktop will remain on for about 1 minute after the cooktop is turned off.

Power Management

Model SINC2B115/LNC2B115, SINCH115V2B/LNCH115V2B, SINCH115V2BCA/SINC2B115CA includes a power management function that will limit total power to 1800W, even when both zones are in use. If you would like to increase the power level of one burner and the total output is 1800W, the cooktop will automatically reduce the power level of the other element as you adjust.

Using the Knob Control Models

To Start Cooking

After the cooktop is connected to a power source, push the knob down and turn the knob in either direction to the setting you want. When the knob is in any position other than OFF, it can be rotated without pushing it down. You may feel a slight bump when it is rotated through min or max positions.

NOTE: A hot surface indicator will glow when any radiant element is turned on and will remain on until the surface is cooled to a safe temperature to touch.

To Turn off the Cooktop

Be sure you turn the control knob to Off when you finish cooking. It will snap into the Off position.

Using the Extended Cooking Zone

- Some of the ceramic cooktop models have one or several extended cooking zones (Oval/Dual/Triple zone), which can provide a larger cooking area and additional heat to fit a larger cooking pan.
- To use extended zone when cooktop is working, follows below:

For Touch/Slider Control Models

1. Activate the cooking zone with the extended zone feature you would like to use.
2. The central zone will be switched on first.
3. With the central heating zone active (power level indicator flashing), touch the extended zone control button  to activate the extended heating zone.

NOTES:

1. Continuously touching the control button will cycle the active heating zones in the following sequences:
 - Oval zone: “Central-Oval-Central-Oval-Central zone...”
 - Dual zone: “Central-Dual-Central-Dual-Central zone...”
2. When the Oval Zone or the Dual Zone are active, the LED indicator of that particular zone will show the heat setting and  alternately.

For Knob Control Models

- Push down and turn the control knob clockwise, toward the  symbol to activate the dual zone heating area.

- Adjust the power of the dual zone by adjusting the control knob to anywhere between ☉ symbol and the midpoint of the dial.
- To deactivate the dual zone, turn the control knob past the midpoint to the left, toward the ○ symbol to either use the single cooking zone or turn the cooking zone off.

Note: You may feel a slight bump when it is rotated through the midpoint or OFF positions.

Using Keep Warm Zone (Ceramic Cooktop)

- A separate Keep Warm cooking area is available on some ceramic cooktops.
- The Keep Warm cooking area can be used to keep cooked foods warm and may be used whether or not the other surface cooking zones are in use. One hour is the recommended maximum time to maintain food quality.
- It is not recommended for heating cold foods. When the Keep Warm zone is in use, it will not glow red like the other cooking zones, but the indicator will glow on the control panel.
- Food quality may deteriorate if food is kept on the Keep Warm zone for an extended period of time. For best results, keep food warm for no longer than 30 to 45 minutes.

Using Booster Function (Induction Cooktop)

Some of the induction cooktop models have one or several cooking zones which has Booster function. You can use the “Booster” function to boost power of the relevant cooking zone for a maximum power rating for 5 minutes.

Using the Booster Function when a Cooking Zone is Working

- 1) Active the cooking zone you want to use booster function.
Touch the heating zone selection control button to select the cooking zone you want to use boost function.



- 2) Touch the Booster function control button , and the heating zone indicator will show “b” and flash for 5 seconds. The booster function is now active.

Notes:

1. When using booster function, if the other cooking zone in vertical direction is also activated at a power level higher than 2, programmer will automatically turn power of the other zone down to 2.
2. After booster function ceases, the other active cooking zone will return to the original power setting.

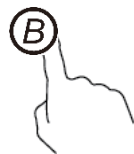

Stopping the Booster Function

- Follow above practice of active Booster function one more time when Booster is working, could cancel the Booster function.
- You can also cancel Booster function by adjust power level setting.

Child Lock Safety Control

NOTE: The Child lock function is for touch/slider control models only.

- You can lock the controls to prevent unintended use (for example children accidentally turning the cooking zones on) by activating the Child Lock function.
- When the controls are locked, except the ON/OFF control button and Child Lock control button, all other touch control buttons are disabled.

To Lock the Controls

Touch the Child Lock control button  once. The timer indicator will show “Lo” and the Child Lock function will be active.

To Unlock the Controls

1. Make sure the electric cooktop is turned on.
2. Touch and hold the Child Lock control button  for 3 seconds, the buzzer beeps once and “Lo” disappears in the timer indicator. The Child Lock is now inactive.

You can now start using your electric cooktop.

Under the child lock mode, all controls buttons be disable except the ON/OFF button  and child lock  button.



You can always turn the cooktop off with the ON/OFF  control in an emergency, but the cooktop will be unlocked the next time it is used.

NOTE: Under Child Lock function, if turn the cooktop off without inactive the Child Lock function. When turn on the cooktop later, the Child Lock function will still valid.

Stop & Go Function

NOTE: The Stop & Go function is for touch/slider models only.

The Stop & Go function can turn off all zones. When you return to the cooktop, simply touch the button to restart cooking at the zones' heat settings.

Activate the Stop & Go Function

Press the Stop & Go function button  once. All temperature program settings be put on hold and the cooktop stop heating. All heat setting indicators will show “P”.

Cancel the Stop & Go Function

After returning to the cooktop, press the Stop & Go function button again. All temperature program settings will return to their previously set temperatures. The Stop & Go indicator “P” disappear from all indicators.



When the Stop & Go function is active, all of the control buttons will be disabled, except the ON/OFF and Stop & Go button.

NOTE: The cooktop will automatically turn off, if the Stop & Go function lasts for more than 10 minutes.

Using the Timer

Note: Timer function is for touch/slider control models only.

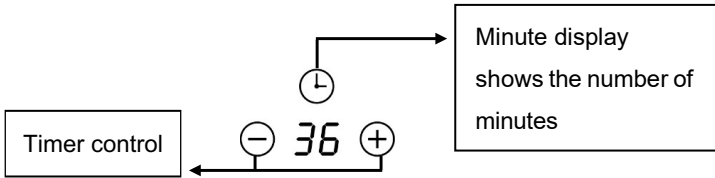

When the cooktop is turned on, you can use the timer in two different ways:



- You can use it as a “minute minder” alert, which can be set for up to 99 minutes. In this case, the timer will not turn any cooking zone off when the set time is up.
- You can set it to turn one or more cooking zones off.

Using the Timer as a Reminder:

If you have not selected any cooking zones, touch the timer control button . The number in timer indicator will start flashing.

To adjust the Minute Minder settings follows the instructions below:

1) Touch control models:

- a. Set the time by touching the  or  button.
- b. If you press and hold either of the two buttons, the value will adjust down or up rapidly in a circle.

NOTE: When the timer indicator is flashing, touching the timer control button once more can quickly confirm the timer setting.

NOTE: For model CRH2BT30115, CRH2BT30230 , SINCH115V2B, SINCH230V2B and SINCH115V2BCA , the timer can be set from 1 to 30 minutes only.

2) Slider Touch control models:

- a. Touch the timer control button  once, and the number in the ones place of the timer indicator will start flashing. Then, adjust the single digit of minute minder by sliding the slider control.
- b. Press the timer control button again, the number in the tens digit of the timer indicator will start flashing. Then, adjust tens digit of the minute minder by sliding the slider control.

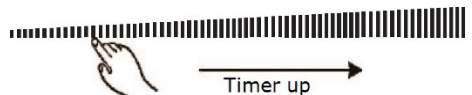



NOTE: By continuously touching the timer control button, the slider works in this sequence: “Single Digit-Tens Digit -Confirm Setting-Single Digit-...”



When the minute minder is set, it will begin to count down immediately and show the remaining time in the display.

The buzzer will beep for 30 seconds, and the timer indicator display shows “- -” when the set time is finished. Press any button to stop the buzzer from beeping.

Setting the Timer to Turn off a Cooking Zone

- 1) Touch the heating zone selection control button  to select the cooking zone you wish to set timer for.
- 2) Touch the timer control button , and the number in the timer indicator display will start flashing. Then adjust timer setting.

1) Touch control models:

- a. Set the time by touching the  or  button.
- b. If you press and hold either of the two buttons, the value will adjust down or up rapidly in circle.

Note: For model CRH2BT30115 and CRH2BT30230, SINCH115V2B, SINCH230V2B and SINCH115V2BCA, the timer can be set from 1 to 30 minutes only.

Note: Model CRH2BT30115, CRH2BT30230, SINCH115V2B, SINCH230V2B and SINCH115V2BCA, will automatically turn off after 30 minutes without any input from the user.

NOTE: When the timer indicator is flashing, touching the timer control button once more can quickly confirm the timer setting.



2) Slider Touch control models:

- a. Touch the timer control button  once, and the number in the ones place of the timer indicator will start flashing. Then, adjust the single digit of minute minder by sliding the slider control.
- b. Press the timer control button again, the number in the tens digit of the timer indicator will start flashing. Then, adjust tens digit of the minute minder by sliding the slider control.

NOTE: By continuous touch the timer control button, the slider works as follows:
“Single Digit-Tens Digit -Confirm Setting-Single Digit-...”

When the minute minder is set, it will begin to count down immediately and show the remaining time in the display.

NOTES:

- The red dot next to the power level indicator will illuminate for those zones set with a timer. 
- After adjusting, the setting in timer indicator will flashing for 5 seconds and then stop flashing, then the setting be confirmed. 
- The default setting of minute reminder and timer is 30 minutes.
- If more than one heating zone has a timer set, the timer indicator will show the lowest time remaining. The red dot next to power level indicator will flash.
- The minute reminder and timer can be used at same time. The timer indicator shows the lowest time setting. If the lowest setting is the minute reminder, the red dot next to timer indicator will flash. If the lowest setting is the timer setting, the red dot of corresponding cooking zone power level indicator will flash.
- If indicator shows the timer setting of a cooking zone and you want to check minute reminder setting, press the timer control button , and the indicator will show minute reminder setting.

Residual Heat Warning

Beware of hot surfaces

- When the cooktop has been operating for some time, there will be some residual heat. The letter “H” appears in power setting indicator to warn you to keep away from it. 

Note for Knob Control Models: A hot surface indicator light will glow  when any radiant element is turned on and will remain on until the surface is cooled to safe temperature.

Auto Shutdown

Another safety feature for touch/slider control cooktop is auto shutdown. This occurs whenever you forget to switch off a cooking zone. The default shutdown times as below table:

Power level	1	2	3	4	5	6	7	8	9
Default working timer (hour)	8	8	8	4	4	4	2	2	2

Overheat Protection

A temperature sensor inside the cooktop monitors its internal temperature. When an excessive temperature is detected, the cooktop will automatically turn off.

Overflow Protection

For your safety, the touch/slider control will automatically shut off the power if boiling liquid or wet cloth touches the control panel. All control buttons became inactive except ON/OFF and Child Lock button, until you wipe the touch control area dry.

Cooking Guidelines

Take care when frying, as the oil and fat heat up quickly, particularly if you are using Booster function. At extremely high temperatures oil and fat can ignite spontaneously, and this presents a risk of fire.

- When food comes to the boil, reduce the power setting.
- Using a lid will reduce cooking times and save energy by retaining the heat.
- Minimize the amount of liquid or fat to reduce cooking times.
- Start cooking on a high setting and reduce the setting when the food has heated through.

Simmering

- Simmering occurs below the boiling point, at around 85°C (185°F), when bubbles are rising occasionally to the surface of the cooking liquid. It is the key to delicious soups and tender stews because flavors develop without overcooking the food. You should also cook egg-based and flour thickened sauces below the boiling point.
- Some tasks, including cooking rice by the absorption method, may require a setting higher than the lowest setting to ensure the food is cooked properly in the time recommended.

Searing steak

1. Stand the meat at room temperature for about 20 minutes before cooking.
2. Heat up a heavy-bottomed frying pan.
3. Brush both sides of the steak with oil. Drizzle a small amount of oil into the hot pan and then lower the meat onto the hot pan.
4. Turn the steak only once during cooking. The exact cooking time will depend on the thickness of the steak and how cooked you want it. Times may vary from about 2 – 8 minutes per side. Press the steak to gauge how cooked it is – the firmer it feels the more ‘well done’ it will be.
5. Leave the steak to rest on a warm plate for a few minutes to allow it to relax and become tender before serving.

For Stir-Frying

1. Choose a ceramic compatible flat-based wok or a large frying pan.
2. Have all the ingredients and equipment ready. Stir-frying should be quick. If cooking large quantities, cook the food in several smaller batches.
3. Preheat the pan briefly and add two tablespoons of oil.
4. Cook any meat first, put it aside and keep warm.
5. Stir-fry the vegetables. When they are hot but still crisp, turn the cooking zone to a lower setting, return the meat to the pan and add your sauce.
6. Stir the ingredients gently to make sure they are heated through.
7. Serve immediately.

Heat Settings

The settings below are guidelines only. The exact setting will depend on factors including your cookware and the amount you are cooking. Experiment with the cooktop to find the settings that best suit you.

Heat setting	Suitability
1 - 2	<ul style="list-style-type: none">• Delicate warming for small amounts of food• Melting chocolate, butter, and foods that burn quickly• Gentle simmering• Slow warming
3 - 4	<ul style="list-style-type: none">• Reheating• Rapid simmering• Cooking rice
5 - 6	<ul style="list-style-type: none">• Pancakes
7 - 8	<ul style="list-style-type: none">• Sautéing• Cooking pasta
9	<ul style="list-style-type: none">• Stir-frying• Searing• Bringing soup to the boil• Boiling water

CLEANING AND MAINTENANCE

CAUTION: Before any maintenance or cleaning work is carried out, DISCONNECT the appliance from ELECTRICITY supply and ensure the appliances is completely cool.

Cleaning the Cooktop Surface

- Clean spillages from the cooktop surface as soon as possible after use. Always ensure the surface is cool enough before cleaning.
- Use a soft cloth or kitchen paper to clean the surface. If the spillage has dried on the surface, you may need to use a specialist vitro-ceramic glass cleaner, which is available for most of supermarkets.
- Do not use other abrasive cleaners and/or wire wool etc., as it may scratch the ceramic glass surface of your cooktop.

Damage from Sugary Spills and Melted Plastic

- Special care should be taken when removing hot substances to avoid permanent damage of the glass surface.
- Sugary spillovers (such as jellies, fudge, candy, syrups) or melted plastics can cause pitting of the surface of your cooktop (not covered by the warranty) unless the spill is removed while still hot. Special care should be taken when removing hot substances.

Tips to Keep your Cooktop Clean

Everyday soiling on glass (fingerprints, general stains left by food or non-sugary spillovers)

1. Switch off the power supply.
2. Apply a vitro-ceramic glass cleaner while the glass is still warm (but not hot!)
3. Rinse and wipe dry with a clean cloth or paper towel.
4. Switch on the power supply to the cooktop.

Notes:

- When turning off the power supply of cooktop, there will be no 'hot surface' indication, but the cooking zone may still be hot! Take extreme care.
- Heavy-duty scourers, some nylon scourers, and harsh/abrasive cleaning agents may scratch the glass. Always read the label to check if your cleaner or scourer is suitable.
- Never leave cleaning residue on the cooktop glass surface: the glass may become stained

Boil over melts and hot/sugary spills on the glass

Remove these immediately with a fish slice, palette knife, or razor blade scraper suitable for ceramic glass of cooktop, but beware of hot cooking zone surfaces:

1. Switch off the power supply.
2. Hold the blade or utensil at a 30° angle and scrape the soiling or spill to a cool area of the cooktop.
3. Clean the soiling or spill up with a dish cloth or paper towel.
4. Follow steps 2 to 4 for 'Everyday soiling on glass' above.

Notes:

- Remove stains left by melts and sugary food or spillovers as soon as possible. If left to cool on the glass, they may be difficult to remove or even permanently damage the glass surface.
- Cut hazard: when the safety cover is retracted, the blade in a scraper is razor-sharp. Use with extreme care and always store safely and out of reach of children.

Spillovers on the touch controls

1. Switch off the power supply.
2. Soak up the spill
3. Wipe the touch control area with a clean damp sponge or cloth.
4. Wipe the area completely dry with a paper towel.
5. Switch on the power supply to the cooktop.

NOTE: The cooktop may beep and turn itself off, and the touch controls may not function while there is liquid on them. Make sure you wipe the touch control area dry before turning the cooktop back on.

TROUBLESHOOTING

If you encounter any issues with your cooktop, consult the table below for a quick resolution before contacting our service team:

ISSUE:	CAUSE/RESOLUTION:
<p><i>There is no power to the appliance</i></p>	<p><i>Check whether there is a power outage.</i> <i>Check whether the appliance is properly connected to the electricity.</i> <i>Has the timer setting elapsed or reached the longest cooking time setting and auto shut off?</i> <i>Is there liquid boiling over the control panel, and has that prompted the auto shutoff?</i></p>
<p><i>The touch control panel buttons can't be activated</i></p>	<p><i>Check if child lock is on</i> <i>Check to see if liquid/wet cloth over touch control panel has activated overflow protection</i></p>
<p><i>After cooking, "H" shows on display</i></p>	<p><i>This is normal. The cooktop is displaying the Residual Heat Warning. It will remain on until the surface is cool enough for touch.</i></p>
<p><i>After turning off the cooktop, the fan remains on.</i></p>	<p><i>This is normal, this is to help appliance completely cool down</i></p>
<p><i>Some pans make crackling or clicking noises</i></p>	<p><i>This is the normal sound of induction coils</i></p>
<p><i>The glass is being scratched</i></p>	<p><i>Check whether you used unsuitable or rough-edged cookware</i> <i>Check whether abrasive cleaning products have been used.</i></p>
<p><i>The heating element of ceramic cooktop turns on and off alternately when working.</i></p>	<p><i>This is a normal feature for ceramic hobs, as internal temperature sensors will prevent the cooktop from reaching dangerous cooking temperatures.</i></p>

If you've checked the table above and find that you still need help with your appliance, call our Customer Service facility at 800-932-4267 between 9:00AM and 5:00PM ET. We will do our best to answer your questions.

NOTES

LIMITED WARRANTY

ONE YEAR LIMITED WARRANTY

Within the 48 contiguous United States, for one year from the date of purchase, when this appliance is operated and maintained according to instructions attached to or furnished with the product, warrantor will pay for factory - specified parts and repair labor to correct defects in materials or workmanship. Service must be provided by a designated service company. Outside the 48 states, all parts are warranted for one year from manufacturing defects. Plastic parts, shelves and cabinets are warranted to be manufactured to commercially acceptable standards, and are not covered from damaged during handling or breakage.

ITEMS WARRANTOR WILL NOT PAY FOR:

1. Service calls to correct the installation of your appliance, to instruct you how to use your appliance, to replace or repair fuses or to correct wiring or plumbing.
2. Service calls to repair or replace appliance light bulbs or broken glass shelves. Consumable parts (such as filters) are excluded from warranty coverage.
3. Damage resulting from accident, alteration, misuse, abuse, fire, flood, acts of God, improper installation, installation not in accordance with electrical or plumbing codes, or use of products not approved by warrantor.
4. Replacement parts or repair labor costs for units operated outside the United States.
5. Repairs to parts or systems resulting from unauthorized modifications made to the appliance.
6. The removal and reinstallation of your appliance if it is installed in an inaccessible location or is not installed in accordance with published installation instructions.

DISCLAIMER OF IMPLIED WARRANTIES; LIMITATION OF REMEDIES

CUSTOMER'S SOLE AND EXCLUSIVE REMEDY UNDER THIS LIMITED WARRANTY SHALL BE PRODUCT REPAIR AS PROVIDED HEREIN. IMPLIED WARRANTIES, INCLUDING WARRANTIES OF MERCHANTABILITY OR FITNESS FOR A PARTICULAR PURPOSE, ARE LIMITED TO ONE YEAR. WARRANTOR SHALL NOT BE LIABLE FOR INCIDENTAL OR CONSEQUENTIAL DAMAGES. SOME STATES DO NOT ALLOW THE EXCLUSION OR LIMITATION OF INCIDENTAL OR CONSEQUENTIAL DAMAGES, OR LIMITATIONS ON THE DURATION OF IMPLIED WARRANTIES OF MERCHANTABILITY OR FITNESS, SO THESE EXCLUSIONS OR LIMITATIONS MAY NOT APPLY TO YOU. THIS WARRANTY GIVES YOU SPECIFIC LEGAL RIGHTS AND YOU MAY ALSO HAVE OTHER RIGHTS, WHICH VARY FROM STATE TO STATE.



WARNING: This product can expose you to chemicals including Nickel (Metallic) which is known to the State of California to cause cancer.

For more information go to www.P65Warnings.ca.gov

Note: Nickel is a component in all stainless steel and some other metallic compositions.

Felix Storch, Inc.
Summit Appliance Division
An ISO 9001:2015 registered company
770 Garrison Avenue Bronx, New York 10474
www.summitappliance.com

SUMMIT®

For parts and accessory ordering,
troubleshooting and helpful hints, visit:

www.summitappliance.com/support