

GB

Instructions for Use



Washing Machine

Thank you for your confidence in purchasing our washing machine, and congratulations on the excellent choice.

Our appliances are friendly to the environment. Your new washing machine meets the requirements of modern clothes care. It consumes less energy, water and washing detergent.

Description of washing machine	3
Cautions	4
Important safety instructions	6
Installation and connection	8
Operation.....	12
Tips for washing and energy saving	19
Cleaning and maintenance	21
Troubleshooting	24
Tables	27
Ownership Registration	29
Warranty	31
Consumer Support.....	32

Description of washing machine

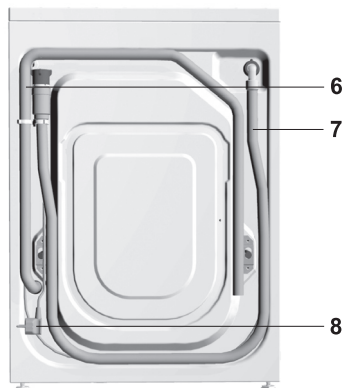

1. Front panel
2. Detergent dispenser
3. Door
4. Filter lid

5. Adjustable legs
6. Water outlet hose
7. Water inlet hose
8. Main power cable

Technical information

Dimensions (w x d x h):

600 mm x 600 mm x 850 mm

Dimensions (w x d x h):

600 mm x 440 mm x 850 mm

Depth with door open:

106 cm / 88 cm (depending on model)

Weight (net): 174 lbs (79 kg)

Nominal voltage: 120 V, 60 Hz

Power: 1500 W

Max. load: 15 lbs (7kg)

Power socket: 120 V, 15 A, 60 Hz

Water pressure:

min. 7 psi (0,05 MPa, max. 116 psi (0,8 MPa)

Fuse: 15 A

Cautions



- **BE SURE TO REMOVE SHIPPING RODS PRIOR TO THE FIRST USE OF THE APPLIANCE. ATTEMPTING TO OPERATE THE MACHINE WITHOUT REMOVING THE SHIPPING RODS MAY RESULT IN IRREPARABLE DAMAGE WHICH IS NOT COVERED UNDER WARRANTY.**
- When connecting your washing machine to the water supply, be sure to use the brand new water inlet hose and appropriate sealing gaskets (included).
- Do not locate the machine in a room with temperature below 0°C. Parts of the machine may be damaged if frozen.
- Install the washing machine in a perfectly horizontal position, on solid flat concrete floor.
- Follow the instructions for correct installation and water and main connections.
- Never immerse the end of the drain hose into the draining water.
- Prior to starting the wash cycle, ensure the door is closed properly.
- Door may not be open during the washing cycle.
- Use only detergents and softeners for machine wash. Manufacturer may not assume responsibility for any damage and eventual discoloring of gaskets and plastic components as a consequence of incorrect use of bleach and/or coloring agents.
- High Efficiency (“HE”) detergent recommended.
- For removal of lime residues use such agents with added anti-corrosion agents. Follow the manufacturer’s instructions. Finish the lime removal by multiple rinsing to completely remove eventual acid residues.
- Never use detergents containing solvents, since there is a danger of creating toxic gasses which may damage the machine and result in ignition or explosion.
- Upon completion of washing operation close the water faucet.



- Before any transport insert at least one shipping rod. Prior to this operation disconnect the appliance from the main power!
- Rating plate with basic information is located on the edge of the door opening.
- The appliance is manufactured in compliance with all relevant safety standards; however, it is recommended that persons with impaired physical, motional, or mental abilities, or persons with inadequate experience and knowledge, do not use the appliance without due supervision. The same recommendation applies to minors using the appliance.



Before connecting the appliance read these instructions carefully. Repairing any failure arising from inappropriate connections or use of the appliance is not covered by the guarantee.



The symbol on the product or on its packaging indicates that this product may not be treated as household waste. Instead it shall be handed over to the applicable collection point for the recycling of electrical and electronic equipment. By ensuring this product is disposed of correctly, you will help prevent potential negative consequences for the environment and human health, which could otherwise be caused by inappropriate waste handling of this product. For more detailed information about recycling of this product, please contact your local city office, your household waste disposal service or the shop where you purchased the product.

Important safety instructions



⚠ To reduce the risk of fire, electric shock, or injury when using your appliance, follow basic precautions, including the following:

1. Read all instructions before using the appliance.
2. Do not wash articles that have been previously cleaned in, washed in, soaked in or spotted with gasoline, dry-cleaning solvents, and other flammable or explosive substances as they give off vapors that could ignite or explode.
3. Do not add gasoline, dry-cleaning solvents, or other flammable or explosive substances to the wash water. These substances give off vapors that could ignite or explode.
4. Under certain conditions, hydrogen gas may be produced in a hot water system that has not been used for 2 weeks or more. **HYDROGEN GAS IS EXPLOSIVE**, if the hot water system has not been used for such a period, before using a washing machine, turn on all hot water faucets and let the water flow from each for several minutes. This will release any accumulated hydrogen gas. As the gas is flammable do not smoke or use an open flame during this time.
5. Do not allow children to play on or in the appliance. Close supervision of children is necessary when the appliance is used near children.
6. Before the appliance is removed from service or discarded, remove the door.
7. Do not reach into the appliance if the tub or agitator is moving.
8. Do not install or store this appliance where it will be exposed to the weather.
9. Do not tamper with controls.
10. Do not repair or replace any part of the appliance or attempt any servicing unless specifically recommended in the user-maintenance instructions or in published user-



repair instructions that you understand and have the skills to carry out.

11. To reduce the risk of electric shock, disconnect the appliance from the power supply before attempting any user maintenance. Turning the control to the »OFF« position does not disconnect the appliance from the power supply.



DANGER

Risk of child entrapment

Before you throw away your old appliance, take off the door so that children cannot easily get trapped inside.

Save these instructions

Grounding instructions

This appliance must be grounded. In the event of malfunction or breakdown, grounding will reduce the risk of electric shock by providing a path of least resistance for electric current. This appliance is equipped with a cord having an equipment-grounding conductor and a grounding plug. The plug must be plugged into an appropriate outlet that is properly installed and grounded in accordance with all local codes and ordinances.



Improper connection of the equipment-grounding conductor can result in a risk of electric shock. Check with a qualified electrician or serviceman if you are in doubt as to whether the appliance is properly grounded.

Do not modify the plug provided with the appliance- if it will not fit the outlet; have a proper outlet installed by a qualified electrician.

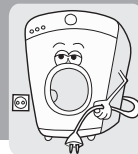

Installation and connection

Package removal

⚠ When removing the wrapping be careful not to damage the appliance with a sharp object.

⚠ Before connecting the appliance, let it warm up to room temperature (wait for two hours).

Removal of transport brackets and shipping rods



- Our appliances are packed in environmentally friendly materials which may be recycled, deposited or decomposed without any threat to the environment.
- To this end all packaging is marked accordingly.
- Move the hoses to allow access to the transport brackets.
- Loosen screws A at the rear of the machine (Fig. 1).
- Remove the brackets B (Fig. 1) by sliding them off the shipping rod (Fig. 1).
- Use the brackets to remove the shipping rods by inserting the notched end of the bracket around the shipping rod (Fig. 2).
- Rotate the bracket 90° in an upward motion to release the shipping rod (Fig. 2).
- Pull the shipping rod out.
- Save bracket and rods for later use.

⚠ Be sure to remove the transport brackets prior to use, otherwise the appliance may be permanently damaged. In such cases the warranty conditions are void.

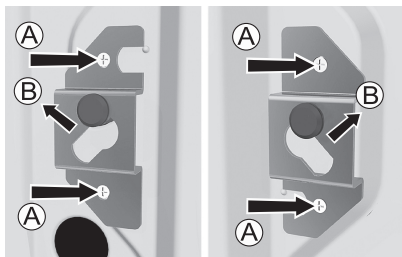

Fig. 1

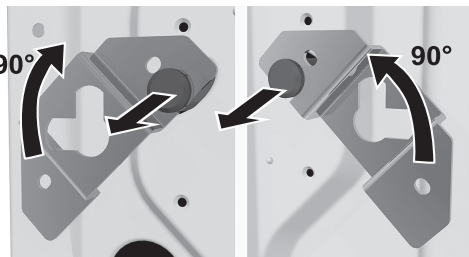
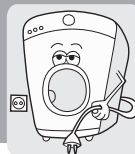

Fig. 2



Leveling the appliance



- Level the appliance by turning the adjustable legs. Placing a “bubble” level on the washer may assist you. The legs are adjustable up to +/- 0,39 inch (1 cm). **After the adjustment tighten the nuts firmly (A) - towards the bottom of the machine!**

- ⚠ **The floor must be a hard surface with a maximum slope of ½” per foot (1,27 cm per 30 cm). To make sure the washer does not vibrate or move, you may have to reinforce the floor.**
- ⚠ **The appliance should be placed on a surface with concrete base; the surface should be dry and clean in order to prevent slipping. The adjustable feet should also be cleaned before installation.**



- If you have a tumble dryer of the same dimensions, you can place it on top of the washing machine.

Water inlet connection

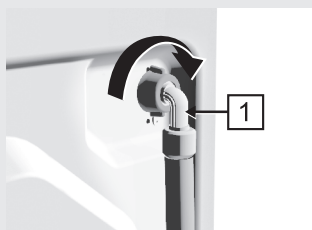

- ⚠ **To ensure correct operation of the appliance, inlet water pressure must be between 7 psi to 116 psi (0,05 MPa and 0,8 MPa).**
- ⚠ **Minimum water pressure can be established by measuring the quantity of poured out water. 0,8 gal (3 litres) of water must be poured out from a completely opened tap in 15 seconds.**

- Take the water inlet hose from the drum and attach the inlet hose angle extension (1) to the washing machine by screwing it onto the provided thread (certain models only).
- Insert the gasket with a filter net into the straight inlet hose attachment nut (2) and screw the nut

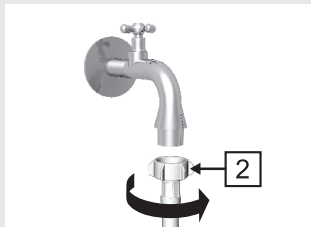
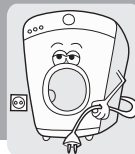

Water outlet connection

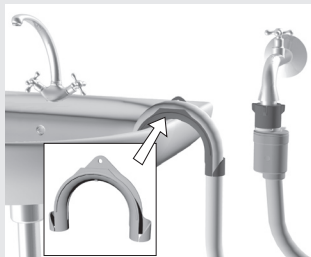

Connect the appliance to the mains supply

onto the water tap. (If your washing machine is fitted with an inlet hose with a partial or complete Aqua-Stop system, the gasket with the filter net is already fitted).

- For hot and cold water connections, connect to the hot and cold faucets as marked at the rear of the appliance (letters C and H) (C - cold; H - hot)

- Fix the outlet hose to drain into the sink or the standpipe (diameter min. 1,6 inch - 4 cm).
- Standpipe must be installed properly and must enable occasional cleaning.
- Fasten the drain hose support with a piece of string or cable tie led through the hose elbow, to prevent the hose from slipping to the floor. The end of drain hose should be placed between minimum 24 inch (60 cm) and maximum 40 inch (100 cm) above the floor level.

- Plug the main power cable to the wall socket.
- Required voltage and other information are written on the rating plate above the door opening of the machine.

⚠ The wall socket must be accessible at all times and must be equipped with a ground lead (in accordance with the local safety regulations).

⚠ Damaged main power cable may be replaced only by the manufacturer or authorized servicer.

⚠ Connect to individual branch circuit.

⚠ WHEN THE WASHING PROGRAM IS OVER, SWITCH THE MACHINE OFF BY DISCONNECTING THE APPLIANCE FROM THE MAIN SUPPLY.

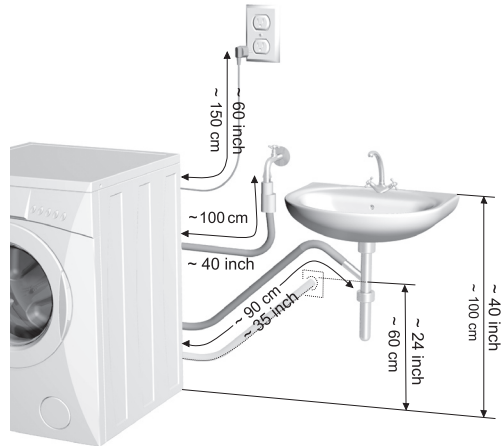
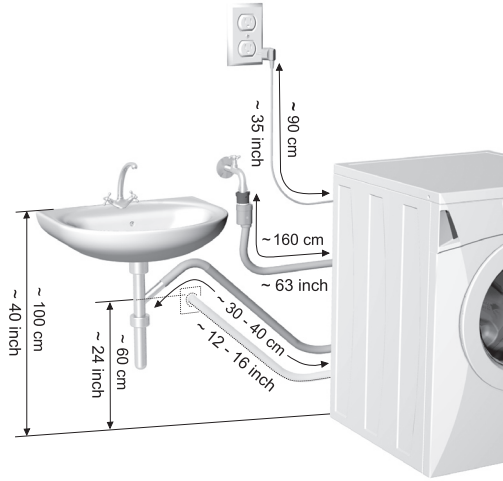

Operation

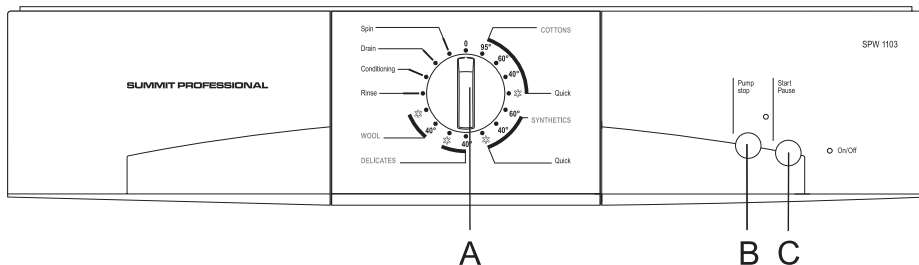

A - program selector
B - Pump stop button
C - START/PAUSE button

Signal LED's: - On/Off (orange)
 - Pump stop (green)

Program selector	Basic programs	Partial programs
	Cottons	Rinse
	Synthetics	Conditioning
	Delicates	Drain
	Wool	Spin

Washing procedure

- Open the door of the machine
- Load the laundry into the drum
- Close the door
- Open the water inlet faucet
- Push the Start/Pause button and select the program
- Add detergent (and softener) into dispenser. See page 16 for instructions about the dispenser.



- **Open the door of the machine.**
Door is opened by pulling the handle (lever) on the right hand side of the door towards you.
- **Sort the laundry by the type of fabric.**

- ⚠ **Fasten buttons and zippers, tie any strings and pull out the pockets.**
- ⚠ **Very delicate laundry should be put in a special protective sack.**
- ⚠ **It is recommended to load the drum with items of different sizes.**
- ⚠ **Pay attention to the labels on the clothes, indicating the recommended washing mode (see table of textile treatment symbols on the last page of these instructions).**

- **Load the laundry into the drum.**
- **Close the door of the appliance.**
- **Open the water inlet faucet.**
- **Push the Start/Pause button** and select washing program.

Washing machine operation

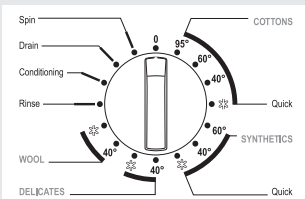

Program is selected by turning the program selector (A) from the “0” position to the desired washing program. The Start/Pause signal LED starts flashing. The program selector (A) may be turned in both directions. Choose the appropriate program according to the type of laundry and desired temperature. For example, cottons and 95°C (Refer to the Program Chart on page 27). You may select basic or partial programs. Selected program may be changed at random prior pushing the START button (C).

- **Selection of basic programs**

Basic programs include all washing stages, softening and spinning (see Program Chart). They are selected by turning the program selector to the appropriate position, including temperature selection.



Cottons: whites/colored

Normally stained cotton: bed linen and underwear, table cloth, bathroom towels, top garments, etc. For less stained laundry of this type, select a cooler wash temperature. It saves energy and washing time.

Synthetics

Normally stained shirts, blouses and other polyester and polyamide garments, or a mixture of these fabrics with cotton.

For less stained laundry of this type, select a cooler wash temperature. It saves energy and washing time.

Delicates

This is a program for delicate fabrics (dresses, skirts, blouses) and curtains.

Wool

Especially gentle program for washing wool and garments made from mixture of other fabrics with wool, appropriately marked for machine washing.

- Selection of additional function

Pump stop

- This function is switched on after the selection of a basic program by pressing the knob (B). It may also be switched on during the operation, prior last rinse. Indicator LED above the washing cycle symbol is lit.
- The function is switched off by pressing the same knob again - signal LED is off.
- The program stops at the end of last rinse, prior spinning: laundry remains soaked in water and prevents crease, if you are unable to remove it from the drum immediately after the end of washing cycle. Indicator LED above the knob is flashing.

SPW 1103

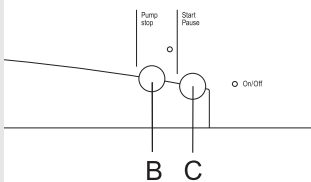

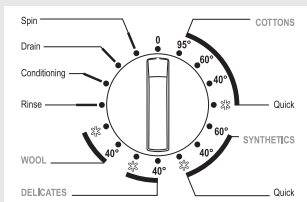

- The selected program is completed by pushing the START button (C), but you may also apply additional programs (pumping or spinning), but you must first return the program selector to the “0” position for at least one second, prior selecting any of the additional programs. When program continues, indicator LED above the knob goes off.

- Selection of partial programs

These are independent programs and may be used when you do not need the entire washing program. In case you would like to use more additional programs in a sequence, you must turn off the appliance prior to any new program selection (turn the program selector (A) to “0” for at least one second). Refer to Program Chart page 27.

Rinse

This program is intended for softening or bleaching washed laundry. It finishes with spinning at 1000 RPM.

Conditioning

Independent program for rinsing delicate laundry, without intermediate spinning and with short final spin. You may use it for rinsing manually washed delicate laundry or for extra rinsing for people with skin sensitive to detergents.

Drain

Use it when the washing program was interrupted or if rinse hold function was engaged, and you only wish to pump the water out of the drum, without spinning.

Spin

Aggressive spinning for non-delicate laundry at high spin RPM.

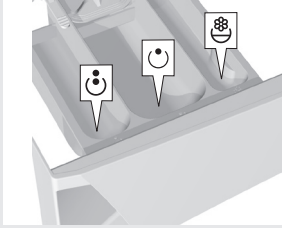

- Adding detergent and fabric softener

(see Tips for washing and energy saving)

- pre-wash compartment ☺
- main wash compartment ☺
- softener compartment ☺

Washing detergent may be added directly into the drum.

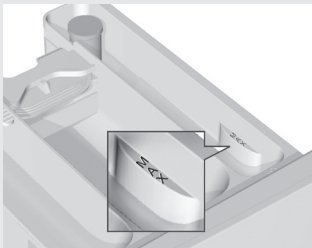

⚠ **When adding softener, be careful to fill the dispenser only up to the marked level.**

⚠ **Be sure to close the detergent dispenser when opening/closing the appliance door.**

Start the operation

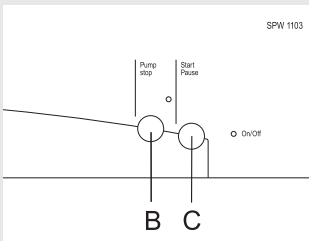

- Push the START button (C). The Start/Pause LED stops flashing, the machine starts operating after a few seconds. If the door is not properly closed after starting the operation, the Start/Pause LED starts flashing again after a few seconds. When you close the door, the machine initiates the selected program.
- In case you would like to alter the washing program after the initiated washing operation, turn the program selector for one second to the position "0", followed by the selection of a new program. Switching the machine off deletes any previously selected additional functions (i.e. PUMP STOP), so they have to be reactivated.

⚠ **If a power failure occurs during the washing program, when the power is restored the machine will resume the execution of a program where it had been interrupted.**



- End of operation

Flashing On/off LED indicates that the program was completed.

- Extract the laundry from the drum and remove any foreign objects from the door gasket.
- Leave the door ajar to allow the interior to dry.
- Close the water inlet faucet.



**SWITCH THE MACHINE OFF BY
DISCONNECTING THE APPLIANCE FROM
MAINS SUPPLY.**



Interruptions

SPW 1103

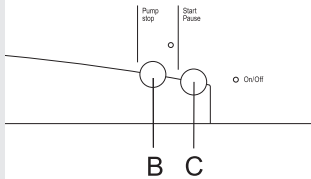

• By the user

Selecting Pump stop function

Program is stopped when it comes to the 'PUMP STOP' stage (if this function had been previously selected). Drum door remains closed all the time. Indicator LED above the 'Pump stop' function starts flashing. Washing procedure is continued by pressing the START knob (C).

Own (physical) interruption

You may also stop the program by turning the program selector to the position "0". If there is water in the drum select one of additional programs (draining, spinning) to empty the water and terminate the program.

Pause button

By pressing the PAUSE button, (C) the program may be suspended at any time. After certain time you may open the door if there is no water in the drum, otherwise this is not possible. Program is continued by pressing the START button (C).

• Failures

Program is suspended in case a failure occurs. Signal LED's are flashing (see Troubleshooting).

• Power failure

At electric cutout the program is interrupted, however, after the power supply has been re-established, the program operation automatically proceeds.

⚠ If a power failure occurs when the drum is still full of water, be careful not to open the door before you drain the water out.

Tips for washing and energy saving



- Before washing sort out the laundry according to the type, degree of dirtiness and color fastness.
- Prior to selecting the washing program consult the sewn tab with information on a particular piece of laundry (see **Maintenance chart** on the last page).
- Wash separately new colored textile products for the first time.
- Wash heavily soiled laundry in small quantities and add more detergent.
- Treat stubborn stains with special stain remover, it will save energy.
- With lightly stained laundry use short program and select lower washing temperature. This way you may save up to 50% of energy.
- Avoid washing very small quantities of laundry to save energy and for better performance of the appliance.
- The largest allowed quantity of dry laundry is indicated in the **Program chart** on page 27.
- Before washing, empty the pockets, close zip fasteners, and remove any metal fasteners or badges that might clog the drain or damage the laundry or drum interior.
- Loosen stacked laundry prior to inserting it into the drum.
- Use only detergents for machine wash.
- Add powder or liquid detergents according to the manufacturer's instructions.
- Chlorine-based whitening agents are not recommended, as it can damage the heater.



In the case of hard water, add appropriate amounts of detergent and water softener according to manufacturer's suggestions.

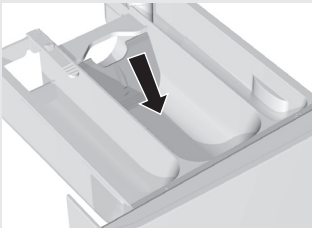
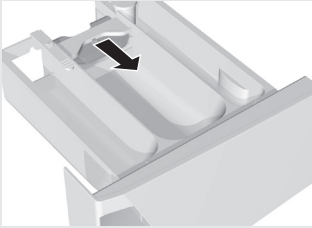

- You may add washing detergent directly into the drum.
- If you use thick liquid softener it is recommended to dilute it with water, to prevent clogging of dispenser compartment ducts.
- Washing machine is equipped with the dispenser partition gate, so you may pour liquid detergent also into the central compartment. If you use powder detergent the gate is lifted up, and in case of liquid detergent it is slid down.
- Insert particularly delicate linen (stockings, delicate female underwear, etc.) into protective wash bags.



Do not put clods of detergent into the soap dispenser as the tube in the washing machine may clog.

Cleaning and maintenance



⚠ Disconnect the washing machine from the main power supply before cleaning!

- The cabinet should be cleaned with soft cloth and mild detergent.
- The interior of the drum and the door gasket is cleaned by washing at 140°F (60°C) without laundry and adding half quantity of detergent.
- Frequent use of low-temperature programs in combination with liquid detergents can lead to development of germs which cause odor in the washing machine.

To prevent this, it is recommended to run the Cotton 95°C program without any laundry at least once per month, using powder detergent.

- If necessary, clean the detergent dispenser. Pull it out from its casing completely by pressing the flap (see Fig.).

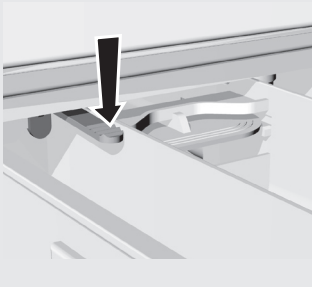

- If necessary, clean the cover of the bung under running water.





- Wash it under running water using a brush, and dry it. Remove any leftover dried detergent from the bottom of the casing.

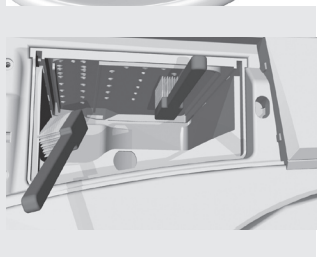

- Clean the entire rinsing area of the washing machine with a brush, especially the nozzles on the upper side of the rinsing chamber.



- Clean the water inlet hose screen under running water regularly.
- After each wash wipe the door rubber gasket. This will prolong its useful life.

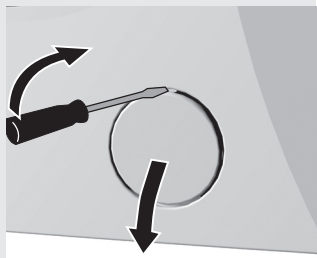

- Open the filter lid using flat screwdriver or similar tool.



- Filter needs occasional cleaning, especially following heavily shaggy or old laundry.



- Before cleaning, drain any water from the machine via drain pipe (certain models only).



- Turn it counter-clockwise, pull it out and clean under running water.

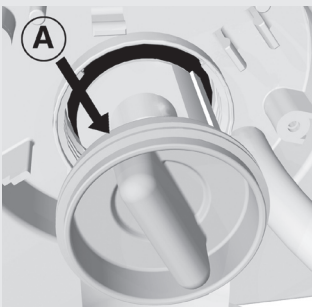

- Insert the filter back as shown on the picture, and tighten by turning it in clockwise direction. To ensure good sealing the gasket surface (A) must be dirt free.



Troubleshooting

The washing machine automatically monitors the execution of particular functions during the operation, and reports any detected failures. In such cases both signal LED's start flashing in certain sequence. Flashing sequence changes in accordance with the nature of the detected failure. In some cases you may attempt correcting certain failures yourself, so count the number of flashes which repeat after a pause.

The machine signals failures immediately after detecting them and stops the program, except for heater failure, where the machine completes the washing program without heating water.

Failures:

In certain cases you may remove the failure yourself (Refer to chart on page 25):

- 2 - two flashes: door is not correctly closed;
- 3 - three flashes: water inlet problem;
- 7 - seven flashes: water outlet problem.

In all other instances mark the number of flashes indicating the failure, switch off the machine and call nearest authorized service center (LED's continue flashing until you switch the machine off).

Environmental interference (for example electrical wiring) could induce signalization of different faults.

In such cases:

- switch the appliance off, and wait for a few seconds;
- switch the appliance back on and repeat the washing program.

If the fault repeats, call authorized service shop.



Failure	Possible cause	Remedy
The machine does not work (symbols are not illuminated).	Machine is not powered.	Check if: <ul style="list-style-type: none"> power in the socket, the fuse is OK, plug is in the socket.
Washing program does not start (Start/Pause LED is flashing).	Door is not properly closed.	Close door firmly.
Water does not enter the machine (after approx. 4 min the machine reports failure -3 flashes).	Water inlet failure.	Check if: <ul style="list-style-type: none"> the water faucet is open, inlet hose screen filter is clean. Push the START button.
Water is leaking from the machine.	Filter is not tightly screwed in. Inlet pipe is not tightly screwed to the machine or to the water faucet. Outlet hose fell to the floor.	Tighten the filter properly. Tighten the inlet pipe. Affix the outlet pipe to the drain.
The machine moves during operation.	The machine is not properly leveled. Transport brackets and shipping rods are not removed.	Level the machine with the adjustable legs. Remove transport brackets and shipping rods.
The machine vibrates during the spin.	Unevenly distributed laundry, especially with very small quantities (for ex. only the bathrobe).	This is normal, the machine will reduce the RPM if vibrations are too strong. Wash larger quantity of laundry.
Excessive foaming during washing.	Excessive measure of detergent.	Use detergent according to the instructions by the producer and according to the water hardness and soiled laundry. Use only detergents <ul style="list-style-type: none"> for machine washing use "HE" detergent.
Water is poorly pumped out or not at all (machine reports failure - seven flashes of LED).	Water outlet is clogged.	Check if: <ul style="list-style-type: none"> the filter is clean, outlet hose is not jammed, outlet hose is positioned higher than 1m. Push START again.
Laundry is not properly spun. No failure is reported.	The machine switched on the UKS function. Because of bad laundry balance, the machine has automatically reduced spin RPM.	The machine operates normally. Wash large and small pieces of laundry together.
Greasy wads appear on the laundry.	Too little detergent (laundry was very greasy).	Wash the laundry again. Add more detergent for such soiled laundry, or use liquid detergent.





Failure	Possible cause	Remedy
Laundry is stained after washing.	You used liquid detergent or detergent for colored laundry which does not contain whitener.	Use the detergent containing whitener.
White powdery residues on the laundry.	It is not the consequence of bad rinsing, but because of neo-phosphate detergents containing non soluble components (zeolites) for water softening. Such substances may be deposited upon the laundry.	Immediately rinse the laundry once again. <ul style="list-style-type: none"> • Use liquid detergents which do not contain zeolites. • Try removing the residues with the brush.
Detergent residues in the dispenser.	Low water flow pressure. Some detergents may stick to the dispenser rather hard if it is wet.	<ul style="list-style-type: none"> • Clean the inlet hose filter screen. • In case of low water pressure increase water level. • Wipe the dispenser prior loading detergent.
Softener is not completely rinsed, or water is left in the dispenser dish.	Syphon cover is not correctly positioned or is clogged.	Clean the dispenser and firmly fix the cover to its place.
Unpleasant smell in the washing machine drum.	<ul style="list-style-type: none"> • Remains of fabrics, washing agent and softener in the filter. • Development of germs 	<ul style="list-style-type: none"> • Check whether the filter is clean. • Run the Cotton 95°C program without any laundry, using a powder detergent.
Washing time is longer than usual.	<ul style="list-style-type: none"> • The machine switched on the UKS* system because of uneven laundry load. • Power failure occurred. 	<ul style="list-style-type: none"> • Washing program time may be up to 60% longer; however, this does not imply a fault in the machine. • Time is prolonged for the power failure period.

* UKS: universal stability control - this function prevents excessive vibrations during spinning.



Tables

Program chart - 15 lbs (7 kg)

Basic program	Max. load		Temp. (°C)	Spin (RPM)	Duration (min.)	Water consumption L	Energy consumption kWh	Additional function Rinse hold
	lbs	kg						
Cotton - white	15	7	95	1000	139	55	2.10	●
Cotton - color	15	7	60		140	52	1.14	●
Cotton - color	15	7	40		116	52	0.66	●
Cotton - quick	15	7			69	52	0.18	●
Synthetic	7,7	3,5	60	1000	112	43	0.93	●
Synthetic	7,7	3,5	40		100	40	0.52	●
Synthetic - quick	7,7	3,5			52	40	0.10	●
Delicates	5,5	2,5	40	700	59	58	0.45	●
Delicates	5,5	2,5			48	58	0.07	●
Wool	4,4	2	40	600	51	42	0.32	●
Wool	4,4	2			40	42	0.02	●
Partial programs								
Rinse	7,7	3,5		700	25	28	0.01	
Conditioning	15	7		1000	13	9	0.01	
Drain	15	7		-	2	-		
Spin	15	7		1000	10	-	0.02	

● possible

* NOTE: represents the inlet water temperature of the cold faucet.





Maintenance chart

Normal wash Delicate wash	95 Max. washing temp. 95°C 95	60 Max. washing temp. 60°C 60	40 Max. washing temp. 40°C 40	30 Max. washing temp. 30°C 30	Manual washing	Washing not allowed
Whitening	Whitening in cold water			Whitening not allowed		
Ironing	Hot iron max. 200°C	Hot iron max. 150°C	Hot iron max. 110°C	Ironing not allowed		
Dry cleaning	Dry cleaning in all solvents	Perchlorin-ethylene R11, R113, Kerosene	Dry cleaning in kerosene, in pure alcohol and in R 113	Dry cleaning not allowed		
Drying	Place on flat surface	Hang wet	Hang	High temperature Low temperature	Tumble drying not allowed	

We reserve the rights to make any changes or mistakes in these operation instructions.