



# Simple User Guide

HW-Q990H



You can access the User guide on Samsung's on-line customer support center by scanning the QR code on the left. To see the manual on your PC or mobile device, download the manual in document format from Samsung's website. (<http://www.samsung.com/support>)

Figures and illustrations in this Simple User Guide are provided for reference only and may differ from actual product appearance.

© 2026 Samsung Electronics Co., Ltd. All rights reserved.

## 01 Checking the Components

- Soundbar
- Subwoofer
- Surround Speaker x 2
- Remote Control / Battery
- Power Cable x 4
- HDMI Cable
- Wall-mounting Guide
- Holder Screw x 2
- Screw (M4 x L10) x 2
- Wall-mounting Bracket x 2
- Rubber-Foot x 4

### Note

- To purchase additional components or optional cables, contact a Samsung Service Center or Samsung Customer Care.
- Some components may differ by model and region, and may not be provided. (e.g., HDMI cable, batteries, etc.)

## 02 Product Overview

### Top side

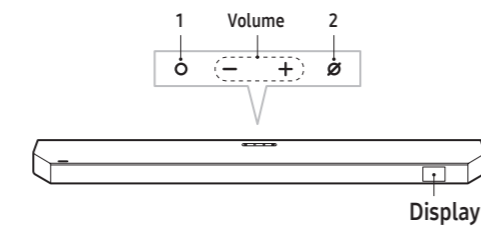

- 1 (Multi) Button**  
In Standby mode, you can turn on the soundbar by pressing the **(Multi)** button. You can switch the input source by pressing the **(Multi)** button.
- 2 (Microphone) button**  
Press the button to turn the microphone on or off. When the microphone is off, the LED indicator will turn red. Press and hold the **(Microphone)** button on the top of the soundbar for 3 seconds or longer to switch to **BT PAIRING** mode.

### Bottom side

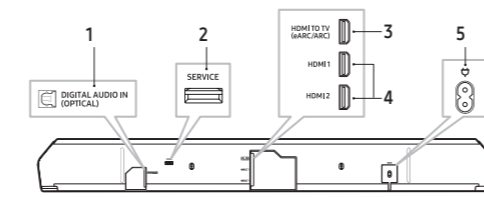

- 1 DIGITAL AUDIO IN (OPTICAL)**  
Connect to a digital (optical) output terminal of TV or external devices.
- 2 SERVICE**  
Use this port to update firmware through USB.
- 3 HDMI TO TV (eARC/ARC)**  
Use this HDMI port to connect to a TV.
- 4 HDMI 1 / HDMI 2**  
This port is used for connecting an HDMI cable to transmit digital video and audio simultaneously. Connect to an HDMI output for external devices.
- 5 (POWER)**  
Connect the power cable to this power port.

## 03 Connecting the Soundbar to Other Units

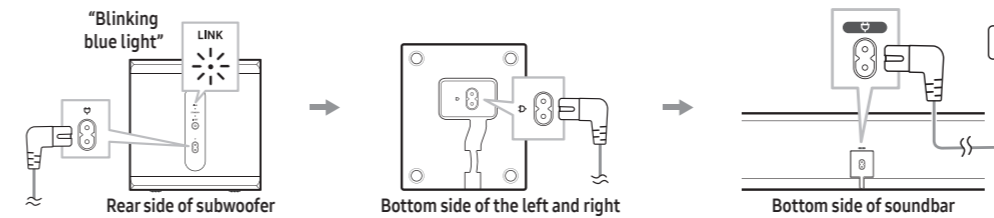

- When the soundbar is properly connected to the subwoofer and surround speakers, the LINK LED indicator will stop blinking and turn solid blue.
- Note**  
Adjust the surround speakers to position them effectively for optimal surround sound. For more information, please refer to the User Guide on the Samsung Electronics website.

## 04 Connecting to the Samsung Sound App

### 1 Installing App

- You can control the soundbar and adjust settings using the Samsung Sound app.
- Download the Samsung Sound app from your mobile device's app store (App Store, Play Store) or scan the provided QR code.



### 2 Registering a Device

1. On your mobile device, run the Samsung Sound app.
  2. Follow the instructions displayed to register the product to your mobile device.
- If a pop-up window does not appear, go to the app's home screen and tap the **(+)** button to register the product.

### Note

You can also register your soundbar to the Samsung Sound app by scanning the QR code on the soundbar.

### 3 Controlling the soundbar with Samsung Sound

1. Open the Samsung Sound app on your mobile device, and then select the soundbar you have registered.
  2. The settings menu will appear for the soundbar, and you can adjust the settings such as **Volume**, **Sound Mode**, and **Equalizer**.
- If another user wants to control the soundbar,
    - Make sure the mobile device is connected to the same Wi-Fi network as the soundbar.
    - Open the Samsung Sound app and follow the on-screen instructions to complete the setup. Once the setup is finished, the soundbar can be controlled through the app.

## 06 Using the Q-Symphony Feature

If you connect the soundbar to a Samsung TV that supports Q-Symphony, sound will play from both the soundbar and TV at the same time. You can enjoy a richer, more immersive sound with the TV's surround sound.

When the soundbar is connected to your TV, "Q-Symphony" will appear on your TV. (Home ( ) → Settings ( ) → All Settings ( ) → Sound → Sound Output)

## 07 Connecting to Bluetooth

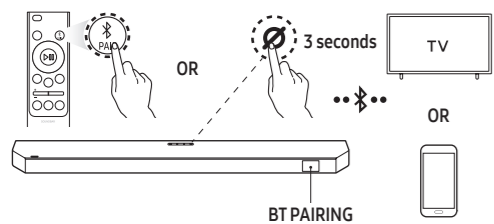

1. Press the **(Bluetooth)** connection button on the remote control or press and hold the **(Microphone)** button for 3 seconds or longer.
2. Search for Bluetooth devices on your TV or mobile device.

### Note

- If prompted for a PIN code when connecting to a Bluetooth device, enter **<0000>**.

## 08 Using the Soundbar Remote Control

- The layout, buttons, and functions of the remote control may vary depending on the model.

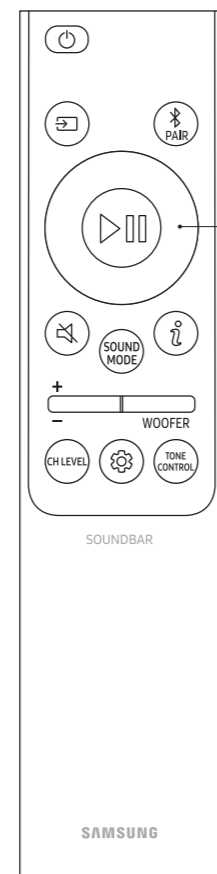

- (POWER)**
- (Input source):** You can select a device connected to the soundbar.
- (Bluetooth):** Press it to enter the Bluetooth pairing mode on the soundbar.
- 1** Directional button (Up/Down/Left/Right)
- (Play/Pause)**
- (Mute):** Press this button to mute the sound. Press it again to unmute.
- (SOUND MODE)** Press it to select a sound mode.
- (Info):** Press this button to see codec information or the current status. In the Bluetooth mode, connected devices will be displayed.
- (Volume)**
  - To mute the sound, press the button.
- WOOFER** You can adjust the subwoofer (bass) levels by pushing the button up or down.
- (LEVEL)** You can adjust the volume levels of each speaker. Press the Up or Down buttons to configure the channel you want to adjust.
  - The channel level specifications may vary depending on the model.
- (Sound Settings):** You can adjust and customize the audio settings. Press the Up or Down buttons to configure the sound settings you want to change.
  - Sound settings may vary by model.
- (TONE CONTROL)** You can adjust the treble and bass volume levels. Press the Up or Down buttons to configure the sound settings you want to change.

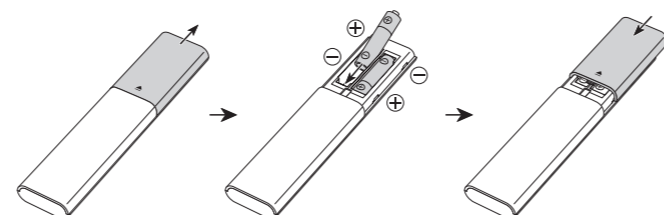

## 09 Installing the Soundbar

### Installing the soundbar on top of the TV stand

- Make sure the soundbar is placed on a flat and solid surface.
- If the soundbar is too close to the TV, voice recognition may be affected, and audio issues could occur.
- As shown in the image, align the center of the TV with the center of the soundbar, then carefully place the soundbar into the TV stand. Make sure the microphone is not blocked when placing the soundbar near the stand to ensure proper voice recognition.
- The actual product may vary in appearance from the image above, depending on the model.

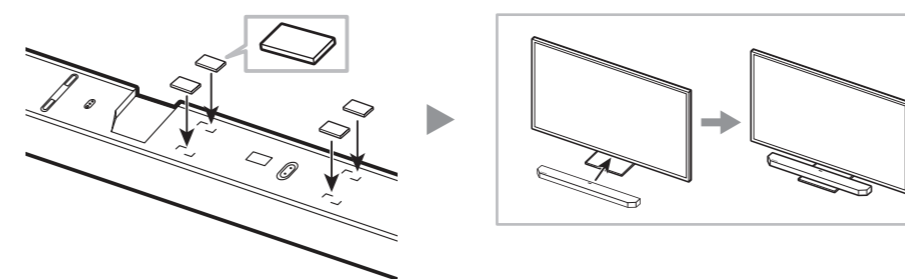

### Installing the soundbar on a wall

- Mount the soundbar only on a vertical wall.
- Avoid installing the soundbar system in areas with high temperatures or humidity.
- Install the system on a sturdy wall capable of supporting the soundbar's weight. If the wall can't support the soundbar's weight, reinforce it before installation. If reinforcement is not possible, choose a different wall that can support the soundbar.
- Use screws or anchor brackets suitable for the wall where the soundbar is being installed. (Gypsum board/steel/wood, etc.) If possible, install the screws directly into the wall.
- Turn off the power and unplug the soundbar before mounting it on the wall. Failure to do so may result in electric shock.
- Connect all cables from external devices before mounting the soundbar on the wall.

## 05 Connecting to TV

### 5-1 Connecting to a TV with Cables

#### Connecting an HDMI Cable

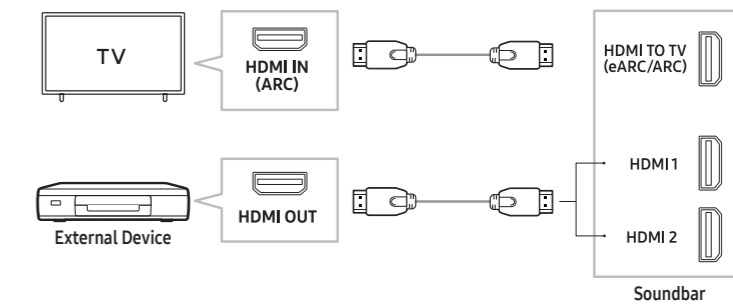

#### Connecting to an Optical Cable

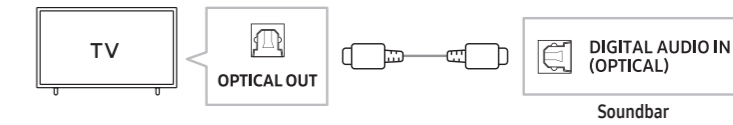

### Note

- If there is no sound from the soundbar, press the **(Multi)** button on the top of the soundbar or press the **(Source)** button on the remote control to switch to the appropriate connected mode.
- Using HDMI cables certified by HDMI.org is recommended.
- When using an optical cable, make sure to remove the cover from the optical cable before use.

### 5-2 Connecting to a TV through Wi-Fi

On the TV Sound menu, change the input source to soundbar.

- Samsung TVs released in 2017 or later: Home ( ) → Settings ( ) → All Settings ( ) → Sound → Sound Output → Soundbar (Wi-Fi)

### Note

- Wi-Fi connection is available only on Samsung TV.
- Connect the soundbar and TV to the same Wi-Fi network.
- Check your TV's manual, as the menu may vary depending on the year of manufacture.

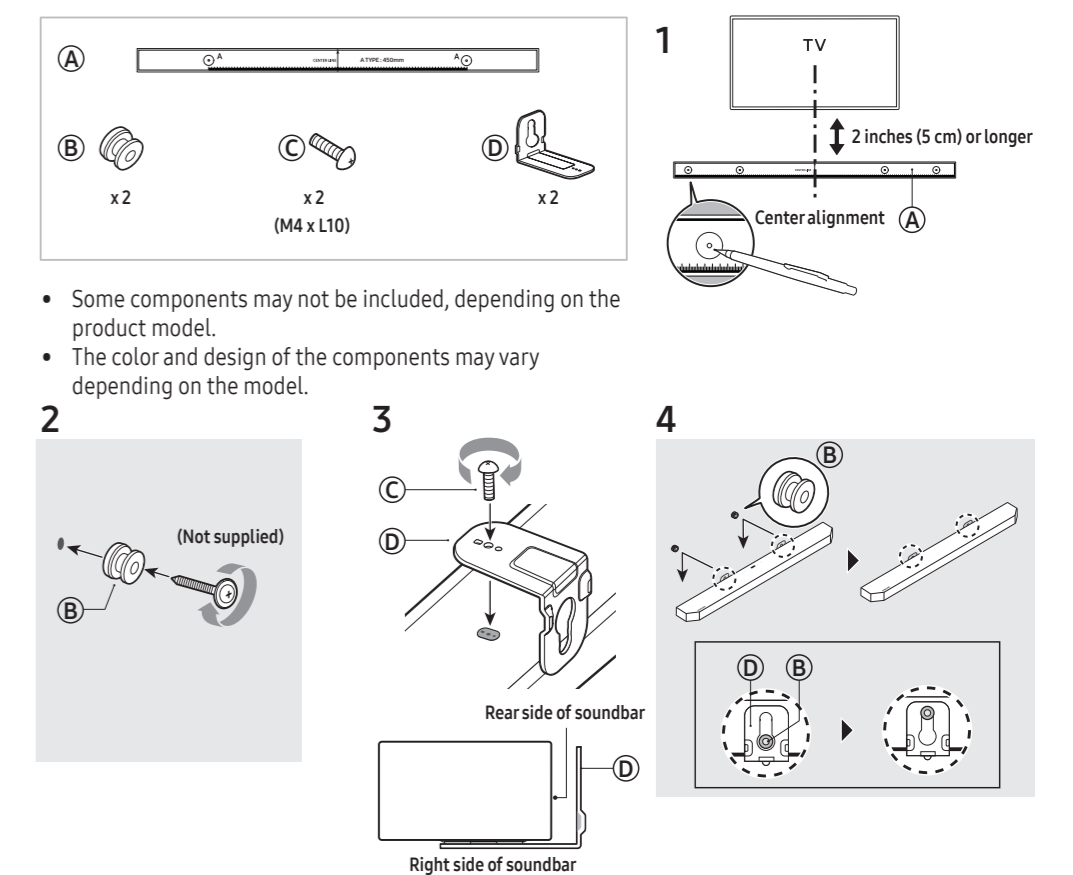

### Note: When mounting surround speakers on a wall (only applicable to certain models)

- The wall used to mount the surround speakers must be able to support at least 17.6 lbs (8 kg).
- Hole size: fits 1/4 - 20 UNC screw
  - Standard screw: 0.25 inches (6.35 mm) ø, 0.05 inches (1.27 mm) pitch / Length: 0.7 inches (18 mm)
  - Quantity: 1 for the left speaker, 1 for the right speaker
- Samsung Electronics doesn't sell wall mounts.

## 10 Troubleshooting

Before seeking assistance, check the following.

### When the power does not turn on

- Check if the power cord is securely connected to the soundbar.

### If the subwoofer and surround speakers don't connect to the soundbar automatically

- Press and hold **ID SET** on the rear of the subwoofer and surround speakers for 5 seconds or longer.

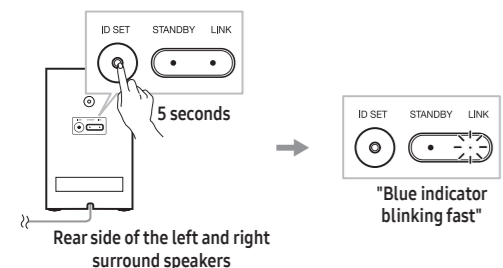
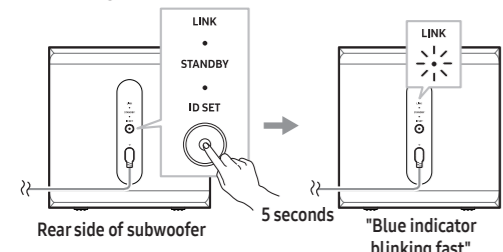

- Press and hold the **UP** button on the soundbar remote control for 5 seconds.

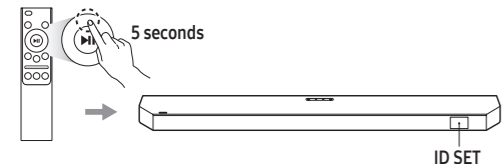

- Make sure the **LINK** LED indicator turns blue (indicating a successful connection).
  - When the soundbar is properly connected to the subwoofer and surround speakers, the **LINK** LED indicator will stop blinking and turn solid blue.

### When some functions are not working properly

- Unplug the power cord, then plug it back in.
- Unplug the power cord from the external device and try again.
- If there is no signal input, the soundbar will automatically turn off after a certain period. Turn on the power.

### If the remote control is not working properly

- Bring the remote control closer to the soundbar and point it directly at the soundbar to select inputs.
- Replace the batteries with fresh ones.

### When the soundbar indicator light stays red

- The microphone is turned off. When the microphone is turned on, the indicator will turn off.

### If there is no sound

- The soundbar volume may be low, or the soundbar may be set to mute. Adjust the volume levels.
- When using external devices (STB, Bluetooth device, mobile device, etc.) connected to the soundbar, adjust the volume on each device.
- The sound output may be set to the TV. Select the soundbar as the sound output for the TV. (Samsung TV: Home ( ) → Settings ( ) → All Settings ( ) → Sound → Sound Output → Select Soundbar)
- Unplug the power cord from the soundbar and plug it in again.

### If there is no sound from the subwoofer or surround speakers

- Check if the LED indicator on the rear of the subwoofer or surround speaker is blue. If the indicator is red or blinking blue, reconnect the soundbar to the subwoofer and surround speakers.
- If there are devices near the Soundbar that may cause wireless interference, the sound may be interrupted. Keep them at least 3.3 ft (1 m) away. Examples: Wireless router or smart outlet with an automatic standby power cut-off feature.

### When the TV can't connect to the HDMI TO TV (eARC/ARC)

- Make sure the HDMI cable is securely connected to the ARC or eARC port.
- The soundbar connection may not work due to other devices (such as set-top boxes, game consoles, etc.) connected to the TV. Connect only the soundbar to the TV, without any other devices.
- HDMI-CEC may not be enabled on the TV. Enable CEC in the TV menu. (Samsung TV: Home ( ) → Settings ( ) → General & Privacy → External Device Manager → Anynet+ (HDMI-CEC) ON)
  - The menu path may vary depending on the model.

### When a Bluetooth connection can't be established

- When connecting a new device to the soundbar, switch to BT PAIRING to connect. Press the **BT** button on the soundbar remote control or press and hold the **Microphone** button for 3 seconds or longer.
- Remove the speaker from the Bluetooth speaker list in the device, then reconnect. (Samsung TV: Home ( ) → Settings ( ) → All Settings ( ) → Sound → Sound Output → Bluetooth Speaker List)

### When the audio stutters due to a weak Bluetooth connection

- Audio may stutter if the soundbar is placed near an electronic device or appliance that causes radio interference. (e.g., microwave oven, wireless router, etc.)
- The sound may cut out if the connected device is too far from the soundbar. Please move the device closer to the soundbar.
- If your body is in contact with the Bluetooth transceiver or the soundbar is placed on metal furniture, the audio may stutter. Check the installation environment and conditions.

### When a Wi-Fi connection can't be established

- Check if your wireless router is on. Turn off the router, then turn it back on and try reconnecting.
- If the wireless router signal is weak, it may not be possible to connect to Wi-Fi. Move the wireless router closer to the soundbar or place it in an unobstructed location.

### When the TV is powered on, but the soundbar does not turn on with it

- If you turn off the soundbar first while watching TV, the Auto Power Link feature on the soundbar will be turned off. Power off the TV first.

### The TV does not show the UHD input signal.

- You may need to adjust the settings on your TV or source device. Refer to your TV or device manual for more details.
- Check if your Ultra High Speed HDMI cable is certified by HDMI.org.

## 11 Specifications and Information

<b>Model name:</b>	HW-Q990H
<b>Weight</b> 7.3 kg	<b>Dimensions (width x height x depth)</b> 1232.0 x 70.8 x 138.0 mm
<b>Subwoofer name:</b>	PS-WQ990H
<b>Weight</b> 8.3 kg	<b>Dimensions (width x height x depth)</b> 249.0 x 251.8 x 249.0 mm
<b>Surround speaker name:</b>	PS-RQ990H (LEFT/RIGHT)
<b>Weight</b> 3.4 kg	<b>Dimensions (width x height x depth)</b> 129.5 x 201.3 x 140.4 mm

### Supported formats for playback

Dolby 5.1ch / Dolby Digital Plus / Dolby TRUE HD / Dolby ATMOS / DTS 5.1ch / DTS HD / DTS-HD Master Audio / DTS:X / LPCM 8Ch

<b>Operating temperature range</b> +10 °C to +40 °C	<b>Operating humidity range</b> 10 % - 80 %, non-condensing
--	--

<b>Storing temperature range</b> -20 °C to +45 °C	<b>Storing humidity level range</b> 5 % - 95 %, non-condensing
--	---

### Precaution : When you activate or deactivate the Wi-Fi or Bluetooth connectivity, the soundbar will automatically restart.

- Press and hold the **CH LEVEL** button on the remote control for 30 seconds or longer to activate or deactivate the Wi-Fi.
- Press and hold the **TONE CONTROL** button on the soundbar remote control for 30 seconds or longer to activate or deactivate the Bluetooth.

### Note

- Samsung Electronics Co., Ltd reserves the right to change the specifications without notice.
- Weight and dimensions are approximate.
- For more information on power supply and power consumption, refer to the label attached on the bottom or back of the product.

For India Only  
This product is RoHS compliant



This marking on the product, accessories or literature indicates that the product and its electronic accessories (e. g. charger, headset, and USB cable) should not be disposed of with other household waste at the end of their working life. To prevent possible harm to the environment or the human health from uncontrolled waste disposal, please separate these items from other types of waste and recycle them responsibly to promote the sustainable reuse of material resources.

For more information on safe disposal and recycling visit our website. [www.samsung.com/in/support](http://www.samsung.com/in/support) or contact our Helpline numbers- 1800 40 SAMSUNG(7267864) 1800 5 SAMSUNG(7267864)

## Safety Information

- The following also applies to the Subwoofer and Surround Speaker SET.

### SAFETY WARNINGS

TO REDUCE THE RISK OF ELECTRIC SHOCK, DO NOT REMOVE THE COVER (OR BACK). NO USER-SERVICEABLE PARTS ARE INSIDE. REFER SERVICING TO QUALIFIED SERVICE PERSONNEL. Refer to the table below for an explanation of symbols which may be on your Samsung product.

	<b>CAUTION</b> RISK OF ELECTRIC SHOCK. DO NOT OPEN.
	This symbol indicates that high voltage is present inside. It is dangerous to make any kind of contact with any internal part of this product.
	This symbol indicates that this product has included important literature concerning operation and maintenance.
	Class II product : This symbol indicates that a safety connection to electrical earth (ground) is not required. If this symbol is not present on a product with a power cord, the product MUST have a reliable connection to protective earth (ground).
	AC voltage : Rated voltage marked with this symbol is AC voltage.
	DC voltage : Rated voltage marked with this symbol is DC voltage.
	Caution. Consult Instructions for use : This symbol instructs the user to consult the user manual for further safety related information.

### WARNING

- To reduce the risk of fire or electric shock, do not expose this appliance to rain or moisture.
- Do not use liquid fumigators containing chemicals, such as mosquito repellent or air freshener, around the product. If steam comes in contact with the product surface or enters the product, it may cause stains or malfunction.
- For crevices or other areas that cannot be thoroughly cleaned with a cloth, use a soft cotton swab, brush, or air blower to remove dirt.

### CAUTION

- TO PREVENT ELECTRIC SHOCK, MATCH WIDE BLADE OF PLUG TO WIDE SLOT, FULLY INSERT.
- This apparatus shall always be connected to a AC outlet with a protective grounding connection.
- To disconnect the apparatus from the mains, the plug must be pulled out from the mains socket, therefore the mains plug shall be readily operable.
- Do not expose this apparatus to dripping or splashing. Do not put objects filled with liquids, such as vases, on the apparatus.
- To turn this apparatus off completely, you must pull the power plug out of the wall socket. Consequently, the power plug must be easily and readily accessible at all times.

## Precautions

- Ensure that the AC power supply in your house complies with the power requirements listed on the identification sticker located on the bottom of your product. Install your product horizontally, on a suitable base (furniture), with enough space around it for ventilation (7-10 cm). Make sure the ventilation slots are not covered. Do not place the unit on amplifiers or other equipment which may become hot. This unit is designed for continuous use. To fully turn off the unit, disconnect the AC plug from the wall outlet. Unplug the unit if you intend to leave it unused for a long period of time.
- During thunderstorms, disconnect the AC plug from the wall outlet. Voltage peaks due to lightning could damage the unit.
- Do not expose the unit to direct sunlight or other heat sources. This could lead to overheating and cause the unit to malfunction.
- Protect the product from moisture (i.e. vases), and excess heat (e.g. a fireplace) or equipment creating strong magnetic or electric fields. Unplug the power cable from the AC wall socket if the unit malfunctions. Your product is not intended for industrial use. It is for personal use only. Condensation may occur if your product has been stored in cold temperatures. If transporting the unit during the winter, wait approximately 2 hours until the unit has reached room temperature before using.
- The battery used with this product contains chemicals that are harmful to the environment. Do not dispose of the battery in the general household trash. Do not expose the battery to excess heat, direct sunlight, or fire. Do not short circuit, disassemble, or overheat the battery. CAUTION : Danger of explosion if the battery is replaced incorrectly. Replace only with the same or equivalent type.

### Contact Samsung World Wide

If you have any questions or comments relating to Samsung products, please contact the Samsung customer care centre.

Country/Region	Samsung Service Center ☎	Web Site
SINGAPORE	1800 7267864   1800-SAMSUNG (All)	<a href="http://www.samsung.com/sg/support">www.samsung.com/sg/support</a>
AUSTRALIA	1300 362 603 (Other) 1300 425 299 (HHP)	<a href="http://www.samsung.com/au/support">www.samsung.com/au/support</a>
NEW ZEALAND	0800 726 7864 (All Products) 0800 726 786 (All products) both numbers are linked with same line	<a href="http://www.samsung.com/nz/support">www.samsung.com/nz/support</a>
VIETNAM	Zalo Samsung Vietnam <a href="https://zalo.me/59884336637438151">https://zalo.me/59884336637438151</a> 	<a href="http://www.samsung.com/vn/support">www.samsung.com/vn/support</a>
THAILAND	Hotline no : 1282 1800-29-3232 (Toll free for all product)	<a href="http://www.samsung.com/th/support">www.samsung.com/th/support</a>
MYANMAR	(General) +95-9-771-001-777 (VIP) +95-9-771-007-771	<a href="http://www.samsung.com/mm/support">www.samsung.com/mm/support</a>
CAMBODIA	1800-20-3232 (Toll free)	<a href="http://www.samsung.com/th/support">www.samsung.com/th/support</a>
LAOS	+856-214-17333	
MALAYSIA	1800-22-8899 (HHP) 1800-88-9999 (OTH) +603-7713 7420 (Overseas contact)	<a href="http://www.samsung.com/my/support">www.samsung.com/my/support</a>
INDONESIA	021-5699-7777 0800-112-8888 (All Product, Toll Free) 0800-112-7777 (All Product, Toll Free)	<a href="http://www.samsung.com/id/support">www.samsung.com/id/support</a>
PHILIPPINES	Dedicated Hotline for Mobile Phones: #GALAXY (just dial #425299)  All Products - 1-800-10-7267864 [ PLDT - Toll Free ] 1-800-8-7267864 [ Globe - Toll Free ] 84222111 [ Landline ]	<a href="http://www.samsung.com/ph/support">www.samsung.com/ph/support</a>
INDIA	1800 5 7267864 (1800 5 SAMSUNG) (Toll-Free) 1800 40 7267864 (1800 40 SAMSUNG) (Toll-Free)	<a href="http://www.samsung.com/in/support">www.samsung.com/in/support</a>
NEPAL	16600172667 (Toll Free for NTC Only) 9801572667 (Toll Free for Ncell users)	<a href="http://www.samsung.com/in/support/contact-us-nepal/">www.samsung.com/in/support/contact-us-nepal/</a>
SRI LANKA	011 SAMSUNG (011 7267864)	<a href="http://www.samsung.com/in/support/contact-us-srilanka/">www.samsung.com/in/support/contact-us-srilanka/</a>
BANGLADESH	08000-300-300 (Toll free) 09612-300-300	<a href="http://www.samsung.com/bd/support">www.samsung.com/bd/support</a>