

# **VEVOR<sup>®</sup>**

## **TOUGH TOOLS, HALF PRICE**

Technical Support and E-Warranty Certificate [www.vevor.com/support](http://www.vevor.com/support)

## **ALUMINUM HANDRAIL**

**MODEL: H8170**

We continue to be committed to provide you tools with competitive price.

"Save Half", "Half Price" or any other similar expressions used by us only represents an estimate of savings you might benefit from buying certain tools with us compared to the major top brands and does not necessarily mean to cover all categories of tools offered by us. You are kindly reminded to verify carefully when you are placing an order with us if you are actually saving half in comparison with the top major brands.

# VEVOR®

## ALUMINUM HANDRAIL

MODEL: H8170

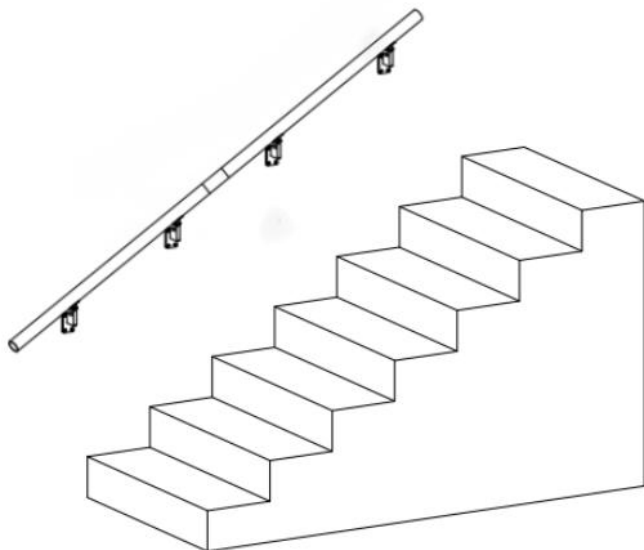

### NEED HELP? CONTACT US!

Have product questions? Need technical support? Please feel free to contact us:

**Technical Support and E-Warranty Certificate**  
**[www.vevor.com/support](http://www.vevor.com/support)**

This is the original instruction, please read all manual instructions carefully before operating. VEVOR reserves a clear interpretation of our user manual. The appearance of the product shall be subject to the product you received. Please forgive us that we won't inform you again if there are any technology or software updates on our product.

## SAFE INSTRUCTIONS

**CAUTION:** Carefully read instructions and procedures for safe operations. Failure to do so can result in serious injury.



### **WARNING:**

1. Before using the handrail, ensure that the handrail is securely installed to prevent personal injury and accidents.
2. When using the handrail, do not overload the handrail to avoid personal injury or accident.
3. Do not draw, cut, or use sharp objects on the handrail to avoid damage.
4. If you need to disassemble the handrail, please follow the reverse steps to disassemble and store it properly.
5. This product is not a toy. Do not allow children to play with this item.

## ASSEMBLY PRECAUTIONS

1. Assemble only according to these instructions. Improper assembly can create hazards.
2. Wear ANSI-approved safety goggles and heavy-duty work gloves during assembly.
3. Keep the assembly area clean and well-lit.
4. Keep bystanders out of the area during assembly.
5. Do not assemble when tired or under the influence of alcohol, drugs or medication.
6. Product capabilities apply to properly and completely assembled products only.
7. For additional information regarding the parts listed in the following pages, please refer to the Assembly Diagram of this manual. Unwrap and separate all parts in a clean work area.
8. For safety reasons, this hardware is recommended to be installed







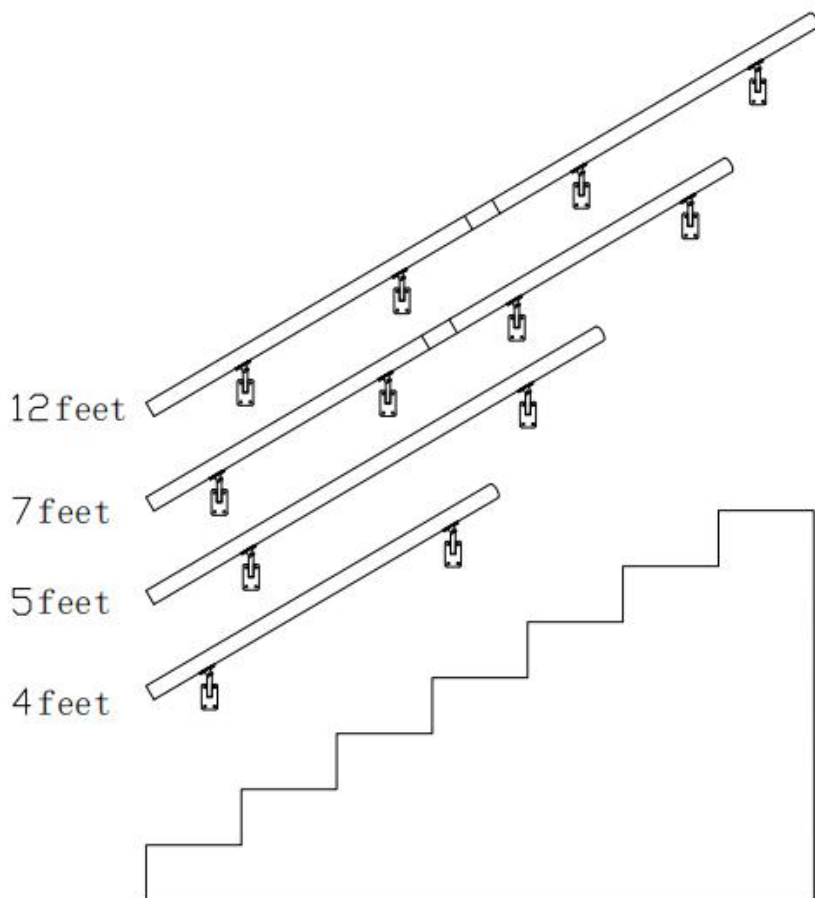

by 2 people.

### SAVE THESE INSTRUCTIONS

Model	H8170-4	H8170-5	H8170-7	H8170-12
Length (ft)	4	5	7	12
Number of Supporting Posts(pcs)	2	2	4	4
Maximum Bearing Capacity (kg)	200	200	200	200



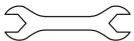



# COMPONENTS

No.	Picture	H8170-4	H8170-5	H8170-7	H8170-12
A		10	10	20	20
B		3	3	6	6
C		-	-	1	1
D		1	1	2	2
E		2	2	4	4
F		1	1	1	1
G		1	1	1	1
H		1	1	1	1
I		-	-	2	2

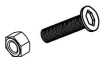
# INSTALLATION INSTRUCTIONS

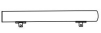
## STEP 1:

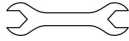
No.	Picture
B	
C	
D	
E	
F	
H	

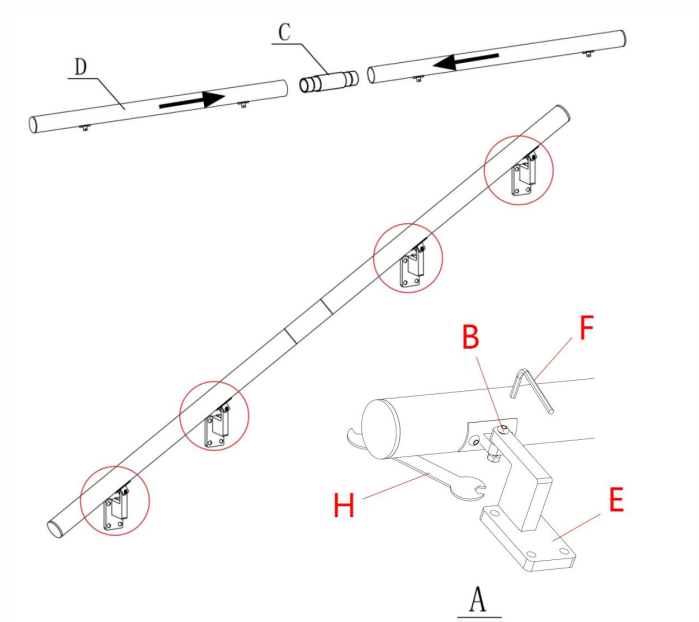

## STEP 2:

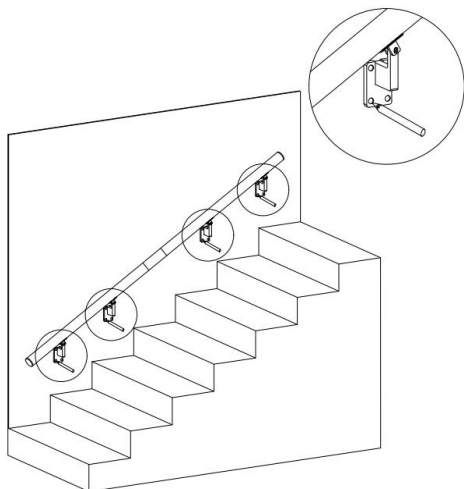

## STEP 3:

No.	Picture
G	

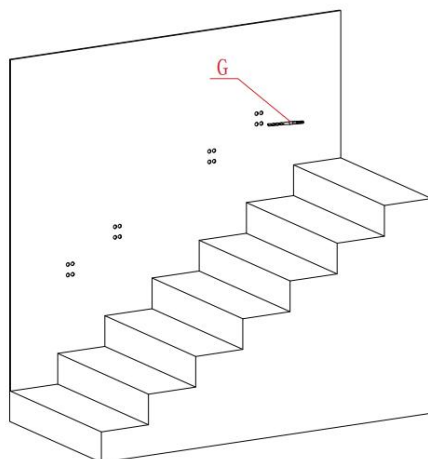

#### STEP4:

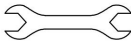
No.	Picture
A	
H	

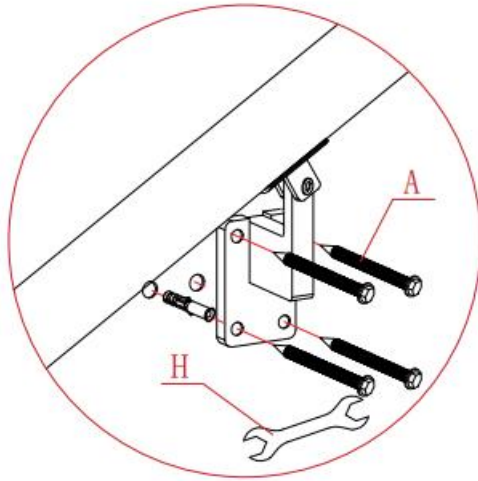

**Above is the H8170-7 installation.**

**Installation of other models are the same as that of H8170-7.**

**Address:** Baoshanqu Shuangchenglu 803long 11hao 1602A-1609shi  
Shanghai

**Imported to AUS:** SIHAO PTY LTD, 1 ROKEVA STREETEASTWOOD  
NSW 2122 Australia

**Imported to USA:** Sanven Technology Ltd., Suite 250, 9166 Anaheim  
Place, Rancho Cucamonga, CA 91730

<b>UK</b>	<b>REP</b>
-----------	------------

Pooledas Group Ltd  
Unit 5 Albert Edward House, The Pavilions  
Preston, United Kingdom

<b>EC</b>	<b>REP</b>
-----------	------------

SHUNSHUN GmbH  
Römeräcker 9 Z2021, 76351  
Linkenheim-Hochstetten, Germany

**VEVOR**®

**TOUGH TOOLS, HALF PRICE**

**Technical Support and E-Warranty Certificate**

**[www.vevor.com/support](http://www.vevor.com/support)**

**Made in China**