

# Gas and Electric Dryer user manual

Imagine the possibilities

Thank you for purchasing this Samsung product.



# contents

---

<b>INSTALLING YOUR DRYER</b>	7	Unpacking your dryer
	7	Basic requirements
	8	Ducting requirements
	9	Important to installer
	9	Location considerations
	9	Alcove or closet installation
	11	Exhausting
	12	Gas requirements
	12	Commonwealth of Massachusetts installation instructions
	13	Electrical requirements
	13	Grounding
	14	Electrical connections
	15	Installation - General procedure
	18	Connecting the Inlet Hose
	18	Final installation check list
	19	Dryer Exhaust Tips
	20	Door Reversal
<b>OPERATING INSTRUCTIONS, TIPS</b>	22	Overview of the control panel
	22	
<b>OPERATING INSTRUCTIONS, TIPS</b>	25	Rack Dry
	26	My Cycle
	26	Drum Light
	26	Sound
	26	Child lock
	27	Smart Care
<b>OPERATING INSTRUCTIONS, TIPS</b>	27	Clean the lint filter
	27	Load the dryer properly
	27	Getting started
	27	Vent sensor
<b>CARE AND CLEANING</b>	30	Control Panel
	30	Tumbler
	30	Powder Coated Tumbler
	30	Dryer Exterior
	30	Dryer Exhaust System
<b>SPECIAL LAUNDRY TIPS</b>	31	Special laundry tips
	31	
<b>TROUBLESHOOTING</b>	32	Check these points if your dryer...
	33	Information codes
	33	
<b>APPENDIX</b>	34	Fabric care chart
	35	Protecting the environment
	35	Declaration of conformity
	35	Specifications
	36	Cycle chart

# safety instructions

Congratulations on your new Samsung Dryer. This manual contains valuable information on the installation, use, and care of your appliance. Please take the time to read this manual to take full advantage of your dryer's many benefits and features.











## WHAT YOU NEED TO KNOW ABOUT SAFETY INSTRUCTIONS

Warnings and Important Safety Instructions in this manual do not cover all possible conditions and situations that may occur. It is your responsibility to use common sense, caution, and care when installing, maintaining, or operating your dryer.

Always contact your manufacturer about problems or conditions you do not understand.

## IMPORTANT SAFETY SYMBOLS AND PRECAUTIONS

What the icons and signs in this user manual mean:

 <b>WARNING</b>	Hazards or unsafe practices that may result in <b>severe personal injury or death</b> . Follow the information in this manual to minimize the risk of fire or explosion or to prevent property damage, personal injury, or death. Do not store or use gasoline or other flammable vapors and liquids near this or any other appliance.
 <b>CAUTION</b>	Hazards or unsafe practices that may result in <b>minor personal injury or property damage</b> .
	Do NOT attempt.
	Do NOT disassemble.
	Do NOT touch.
	Follow directions explicitly.
	Unplug the power plug from the wall socket.
	Make sure the machine is grounded to prevent electric shock.
	Call the service center for help.
	Note

These warning icons are here to prevent injury to you and others.

Please follow them explicitly.

After reading this section, keep it in a safe place for future reference.

 Read all instructions before using the appliance.

# safety instructions

---



**WARNING:** To reduce the risk of fire, electric shock, or injury to persons when using your appliance, follow basic precautions, including the following:

1. Read all instructions before using this appliance.
2. Do not dry articles that have been previously cleaned in, washed in, soaked in, or spotted with gasoline, dry-cleaning solvents, or other flammable or explosive substances, as they give off vapors that could ignite or explode.
3. Do not use the dryer to dry clothes which have traces of any flammable substance, such as vegetable oil, cooking oil, machine oil, flammable chemicals, paint thinner, etc., or anything containing wax or chemicals, such as mops and cleaning cloths. Flammable substances may cause the fabric to catch fire by itself.
4. Do not store or use gasoline or other flammable vapors and liquids near this or any other appliance.
5. Do not allow children to play on or in the appliance. Close supervision of children is necessary when the appliance is used near children.
6. Before the appliance is removed from service or discarded, remove the door to the drying compartment.
7. Do not reach into the appliance if the drum is moving.
8. Do not install or store this appliance where it will be exposed to the weather.
9. Do not tamper with internal controls.
10. Do not repair or replace any part of the appliance or attempt any service unless specifically recommended in the user-maintenance instructions or in published user-repair instructions that you understand and have the skills to carry out.
11. Do not use fabric softeners or products to eliminate static unless recommended by the manufacturer of the fabric softener or product.
12. Clean the lint screen before or after each load.
13. Do not use heat to dry articles containing foam rubber or similarly textured rubber-like materials.
14. Keep area around the exhaust opening and adjacent surrounding areas free from the accumulation of lint, dust, and dirt.
15. The interior of the appliance and exhaust duct should be cleaned periodically by qualified service personnel.
16. Do not place items exposed to cooking oils in your dryer. Items contaminated with cooking oils may contribute to a chemical reaction that could cause a load to catch fire.
17. This appliance must be grounded. See "Electrical requirements" and "Grounding" in installing your dryer section.
18. Do not allow children to play on or in the appliance. Close supervision of children is necessary when the appliance is used near children.
19. Do not insert your hand under the dryer.
  - This may result in injury.
20. Take care that children's fingers are not caught in the door when closing it.
  - This may result in injury.



## WARNING - Risk of Fire

- Clothes dryer installation must be performed by a qualified installer.
- Install the clothes dryer according to the manufacturer's instructions and local codes.
- Do not install a clothes dryer with flexible plastic venting materials. If flexible metal (foil type) duct is installed, it must be of a specific type identified by the appliance manufacturer as suitable for use with clothes dryers. Flexible venting materials are known to collapse, be easily crushed, and trap lint. These conditions will obstruct clothes dryer airflow and increase the risk of fire.
- To reduce the risk of severe injury or death, follow all installation instructions.



### To reduce the risk of fire or explosion:

- Do not dry items that have been previously cleaned, washed, soaked, or spotted with gasoline, dry cleaning solvents, or other flammable or explosive substances. They emit vapors that could ignite or explode. Any material that has been in contact with a cleaning solvent or flammable liquids or solids should not be placed in the dryer until all traces of these flammable liquids or solids and their fumes have been removed. There are many highly flammable items used in homes, such as acetone, denatured alcohol, gasoline, kerosene, some liquid household cleaners, some spot removers, turpentine, wpees, and wpe removers.
- Items containing foam rubber (may be labeled latex foam) or similarly textured rubber-like materials must not be dried on a heat setting. Heated foam rubber materials can, under certain circumstances, produce fire by spontaneous combustion.



### What to do if you smell gas:

- Do not try to light any appliance.
- Do not turn on the appliance.
- Do not touch any electrical switch.
- Do not use any phone in your building.
- Clear the room, building or area of all occupants.
- Immediately call your gas supplier from a neighbor's phone. Follow the gas supplier's instructions.
- If you cannot reach your gas supplier, call the fire department.
- Installation and service must be performed by a qualified installer, service agency, or the gas supplier.



### Gas Appliances:

**WARNING:** This product contains chemicals known to the State of California to cause cancer and reproductive toxicity.

Gas appliances can cause low-level exposure to Proposition 65 listed substances, including but not limited to , benzene, carbon monoxide, formaldehyde and soot, substances resulting from the incomplete combustion of natural gas or LP fuels.

# safety instructions

---

 Do not allow children or pets to play on, in, or in front of the appliance. Close supervision is necessary when the appliance is used near children and pets.

Before discarding or removing your dryer from service, remove the door to the drying compartment to prevent children or animals from becoming trapped inside.

 Do not reach into the appliance when the drum is moving.

Do not install or store this appliance where it will be exposed to the weather.

Do not tamper with controls.

 Do not repair, replace, or attempt to service any part of the appliance unless specifically instructed to in the user-repair instructions and you have the understanding and skills to carry out the procedure.

Do not use fabric softeners or products to eliminate static unless the softener or product is recommended for dryer use by the manufacturer of the fabric softener or product.

Clean the lint screen before or after each load.

Keep the area around the exhaust opening and surrounding areas free from lint, dust, and dirt.

The interior of the dryer and exhaust duct should be cleaned periodically by qualified service personnel.

 This appliance must be properly grounded. Never plug the power cord into a receptacle that is not grounded adequately or not in accordance with local and national codes. See installation instructions for information about grounding this appliance.

Do not sit on top of the dryer.

 **WARNING** Ensure pockets are free from small, irregularly shaped hard objects, foreign material, etc. ie. coins, knives, pins, etc. These objects could damage your dryer.

Do not wash clothing with large buckles, buttons, or other heavy metal or solid objects.

 **WARNING** Gas leaks may occur in your system, resulting in a dangerous situation.

Gas leaks may not be detected by smell alone.

Gas suppliers recommend you purchase and install a UL-approved gas detector.

Install and use in accordance with the manufacturer's instructions.

Do not place items in your dryer that have been spotted or soaked with vegetable oil or cooking oil. Even after being washed, these items may contain significant amounts of these oils.

Residual oil on clothing can ignite spontaneously. The potential for spontaneous combustion increases when items containing vegetable oil or cooking oil are exposed to heat. Heat sources such as your dryer can warm these items, allowing an oxidation reaction in the oil to occur. Oxidation creates heat. If this heat cannot escape, the items can become hot enough to catch fire. Piling, stacking, or storing these kinds of items may prevent heat from escaping and can create a fire hazard.

All washed and unwashed fabrics that contain vegetable oil or cooking oil can be dangerous. Washing these items in hot water with extra detergent will reduce, but not eliminate, the hazard. Always use the Cool Down cycle for these items to reduce their temperature. Never remove these items from the dryer hot or interrupt the drying cycle until the items have run through the Cool Down cycle. Never pile or stack these items when they are hot.

# installing your dryer

## UNPACKING YOUR DRYER

Unpack your dryer and Inspect it for shipping damage. Make sure you have received all of the items shown below. If your dryer was damaged during shipping, or you do not have all of the items, contact 1-800-SAMSUNG (726-7864).

To prevent personal injury or strain, wear protective gloves whenever lifting or carrying the dryer.



**WARNING** Packing materials can be dangerous to children. Keep all packing material (plastic bags, polystyrene, etc.) well out of children's reach.

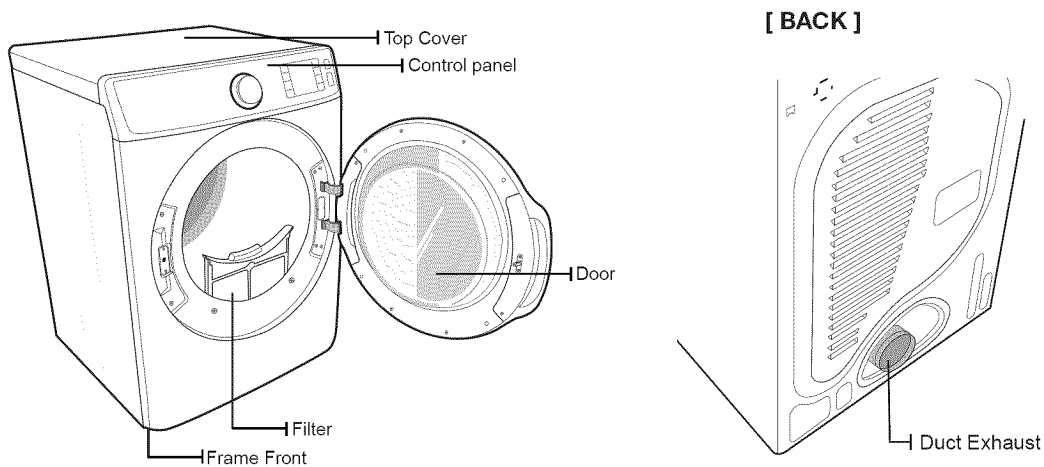

### Tools needed



Pliers



Cutting knife



Pipe wrench (gas only)



Nut drivers



Level



Phillips Screwdriver



Duct tape



Wrench

### Parts supplied



Rubber washer



"Y"- Connector



Hose water



Short inlet hose

## BASIC REQUIRMENTS

Make sure you have everything necessary for proper installation

- A GROUNDED ELECTRICAL OUTLET is required. See Electrical Requirements.
- A POWER CORD for electric dryers (except in Canada).
- GAS LINES (if installing a gas dryer). The gas lines must meet national and local codes.
- EXHAUST SYSTEM - must be rigid metal or flexible stiff-walled metal exhaust ducting.

# installing your dryer

## DUCTING REQUIREMENTS

- Use a 4-inch (10.2 cm) diameter rigid aluminum or rigid galvanized steel duct.
- Do not use a smaller duct.
- Ducts larger than 4 inches (10.2 cm) in diameter can cause increased lint accumulation. Lint accumulation should be cleaned regularly.
- If a flexible metal duct must be used, use the type with a stiff sheet metal wall. Do not use a flexible duct with a thin foil wall. Serious blockage can result if the flexible metal duct is bent too sharply.
- Never install any type of flexible duct in walls, ceilings, or other concealed spaces.
- Keep the exhaust duct as straight and short as possible.
- Secure joints with duct tape. Do not use screws.
- Plastic flexible duct can kink, sag, be punctured, reduce airflow, extend drying times, and affect dryer operation.
- Exhaust systems longer than recommended can extend drying times, affect machine operation, and may collect lint.
- The exhaust duct should end with an exhaust hood with a swing-out damper to prevent back drafts and the entry of wildlife. Never use an exhaust hood with a magnetic damper.
- The hood should have at least 12 inches (30.5 cm) of clearance between the bottom of the hood and the ground or other obstruction. The hood opening should point down.
- Never install a screen over the exhaust outlet.
- To avoid lint buildup, do not exhaust the dryer directly into a window well. Do not exhaust under a house or porch.
- If exhaust ductwork must run through an unheated area, the duct should be insulated and slope slightly down towards the exhaust hood to reduce condensation and lint buildup.
- Inspect and clean the interior of the exhaust system at least once a year. Unplug the power cord before cleaning.
- Check frequently to be sure the exhaust hood damper opens and closes freely.
- Check once per month, and clean at least one time per year. Note: If clothes are not getting dry, then check ducting for obstructions.
- Do not exhaust dryer into any wall, ceiling, crawl space, or concealed space of a building, gas vent, or any other common duct or chimney. This could create a fire hazard from lint expelled by the dryer.

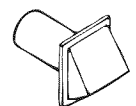
ELECTRIC AND GAS DRYER				
Weather Hood Type				
Recommended			Use only for short-run installation	
 4" (10.2 cm)			 2.5" (6.4 cm)	
No. of 90° elbows	Rigid	Metallic Flexible*	Rigid	Metallic Flexible*
0	80 ft. (24.4 m)	41 ft. (12.4 m)	74 ft. (22.6 m)	33 ft. (10.1 m)
1	68 ft. (20.7 m)	37 ft. (11.2 m)	62 ft. (18.9 m)	29 ft. (8.8 m)
2	57 ft. (17.4 m)	33 ft. (10.1 m)	51 ft. (15.5 m)	25 ft. (7.6 m)
3	47 ft. (14.3 m)	29 ft. (8.8 m)	41 ft. (12.5 m)	21 ft. (6.5 m)

\* Do not use non-metallic flexible duct.

If the new dryer is being installed into an existing exhaust system, you must make sure:

- The exhaust system meets all local, state, and national codes.
- That a flexible plastic duct is not used.
- To Inspect and clean all lint buildup from inside the existing duct.
- The duct is not kinked or crushed.
- The exhaust hood damper opens and closes freely.

The static pressure in any exhaust system must not exceed 0.83 inches of water column, or be less than 0.

This can be measured with the dryer running with a manometer at the point where the exhaust duct connects to the dryer. A no-heat setting should be used. The dryer tumbler should be empty and the lint filter clean.

## IMPORTANT TO INSTALLER

Please read the following instructions carefully before installing the dryer. These instructions should be kept for future reference.

 **WARNING** Remove the door from all discarded appliances to avoid the danger of a child suffocating.

## LOCATION CONSIDERATIONS

Locate the dryer where there is enough space at the front for loading the dryer, and enough space behind for the exhaust system. This dryer is factory-ready for rear exhaust. To exhaust out the bottom or the right or the left (electric model only), use the accessory exhaust kit (sold separately). Instructions are included with the kit. It's important to make sure the room has enough fresh air. The dryer must be located where there is no air-flow obstruction.

On gas dryers, adequate clearance as noted on the data plate must be maintained to ensure adequate air for combustion and proper dryer operation.

Do not install or store the dryer in an area where it will be exposed to water and/or weather. Keep the dryer area clear of combustible materials, gasoline, and other flammable vapors and liquids. A dryer produces combustible lint. The area around the dryer should be kept lint free.

## ALCOVE OR CLOSET INSTALLATION

### MINIMUM CLEARANCES FOR CLOSET AND ALCOVE INSTALLATIONS:

- |                      |                             |
|----------------------|-----------------------------|
| Sides – 1 in / 25 mm | Top – 17 in / 432 mm        |
| Rear – 5 in / 127 mm | Closet Front – 2 in / 51 mm |

If the washer and dryer are installed together, the closet front must have at least a 72 in<sup>2</sup> (465 cm<sup>2</sup>) unobstructed air opening. Your washer alone does not require a specific air opening.

- Recessed area
- Side view - closet or confined area

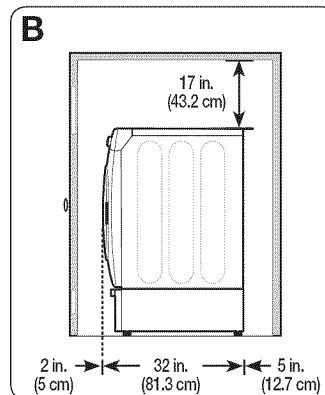
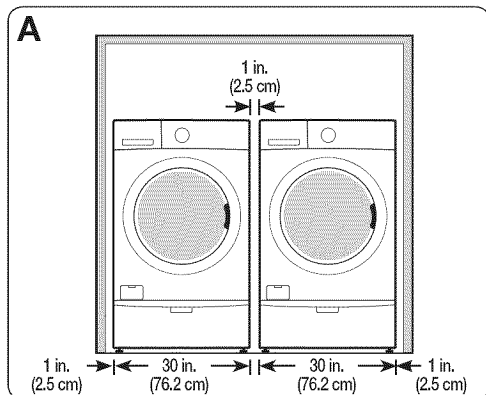



## EXHAUSTING

The dryer shall not be exhausted into a chimney, a wall, a ceiling, an attic, a crawl space, or a concealed space of a building.

Exhausting the dryer to the outside will prevent large amount of lint and moisture from being blown into the room.

### In the United States:

- All dryers must be exhausted to the outside.
- The required exhaust duct is 4 inches (10.2 cm) in diameter.
- Use only those foil-type flexible ducts, if any, specifically identified for use with the appliance by the manufacturer and that comply with the Outline for Clothes Dryer Transition Duct, Subject 2158A shall be used.
- See “Ducting Requirements” in installing your dryer section for the maximum duct length and number of bends shall be used.
- The total length of flexible metal duct shall not exceed 2.4 m.
- Do not assemble the duct with screws or other fastening means that extend into the duct and catch lint

### In Canada:

- All dryer must be exhausted to the outside.
- The exhaust duct should be 4 inches (10.2 cm ) in diameter.
- Use only those foil-type flexible ducts, if any, specifically indentified for use with the appliance by the manufacturer shall be used.
- See “Ducting Requirements” in installing your dryer section for the maximum duct length and number of bends.
- The total length of flexible metal duct shall not exceed 2.4 m.
- Do not assemble the duct with screws or other fastening means that extend into the duct and catch lint.

### Outside the U.S. and Canada:

- Refer to the local codes.



You must exhaust the dryer to the outside to reduce the risk of fire when you install the dryer in an alcove or closet.

**NEVER USE A PLASTIC OR NON-METAL FLEXIBLE DUCT.**

If your existing ductwork is plastic, non-metal, or combustible, replace it with metal.

Use only a metal exhaust duct that is non-flammable to ensure containment of exhaust air, heat, and lint.

# installing your dryer

---

## GAS REQUIREMENTS

---

Use only natural or LP (liquid propane) gases.

**THE INSTALLATION MUST CONFORM WITH LOCAL CODES, OR IN THE ABSENCE OF LOCAL CODES, WITH THE NATIONAL FUEL GAS CODE ANSI/Z223.1, LATEST REVISION (FOR THE UNITED STATES), OR WITH THE CAN/CGA-B149 INSTALLATION CODES (FOR CANADA).**

Gas dryers are equipped with a burner vent for use with natural gas. If you plan to use your dryer with LP (liquid propane) gas, it must be converted for safe and proper performance by a qualified service technician. A 1/2" (1.27 cm) gas supply line is recommended and must be reduced to connect to the 3/8" (1 cm) gas line on your dryer. The National Fuel Gas Code requires that an accessible, approved manual gas shut-off valve be installed within 6" of your dryer.

**Gas dryers installed in residential garages must be raised 18 inches (46 cm) above the floor.**

Additionally, a 1/8" (0.3 cm) N.P.T. (National Pipe Thread) plugged tapping, accessible for test gauge connection, must be installed immediately upstream of your dryer's gas supply connection.

Your dryer must be disconnected from the gas supply pipe system during any pressure testing of the system.

**DO NOT** reuse old flexible metal gas lines. Flexible gas lines must be design certified by the American Gas Association (CGA in Canada).



- Any pipe joint compound used must be resistant to the action of any liquefied petroleum gas.
- As a courtesy, most local gas utilities will inspect a gas appliance installation.

**GAS IGNITION** – Your dryer uses an automatic ignition system to ignite the burner. There is no constant burning pilot.

## COMMONWEALTH OF MASSACHUSETTS INSTALLATION INSTRUCTIONS

---

Your dryer must be installed by a licensed plumber or gas fitter. A "T" handle manual gas valve must be installed in the gas supply line to your dryer. If a flexible gas connector is used to install your dryer, the connector can be no longer than 3' (36").



- Gas leaks may occur in your system, creating a dangerous situation.
- Gas leaks may not be detected by smell alone.
- Gas suppliers recommend you purchase and install a UL-approved gas detector.
- Install and use in accordance with the manufacturer's instructions.

## ELECTRICAL REQUIREMENTS

---



The wiring diagram is located on the plate below the control panel or frame back.



- Improperly connecting the equipment grounding conductor can result in a risk of electric shock. Check with a qualified electrician or serviceman if you are in doubt as to whether your dryer is properly grounded. Do not modify the plug provided with your dryer – if it doesn't fit the outlet, have a proper outlet installed by a qualified electrician.
- To prevent unnecessary risk of fire, electrical shock, or personal injury, all wiring and grounding must be done in accordance with local codes, or in the absence of local codes, with the National Electrical Code, ANSI/NFPA No. 70-Latest Revision (for the U.S.) or the Canadian Electrical Code CSA C22.1 – Latest Revisions and local codes and ordinances. It is your responsibility to provide adequate electrical services for your dryer.
- All gas installations must be done in accordance with the national Fuel Code ANSI/Z2231 – Latest Revision (for the U.S.) or CAN/CGA – B149 Installation Codes – Latest Revision (for Canada) and local codes and ordinances.

## GROUNDING

---

This dryer must be grounded. In the event of malfunction or breakdown, the ground will reduce the risk of electrical shock by providing a path of least resistance for the electrical current.



### Gas models

Your dryer has a cord with an equipment-grounding conductor and a grounding plug.

The plug must be plugged into an appropriate outlet that is properly installed and grounded in accordance with all local codes and ordinances.

Do not modify the plug provided with your dryer – if it doesn't fit the outlet, have a proper outlet installed by a qualified electrician.

Never connect the ground wire to plastic plumbing lines, gas lines, or hot water pipes.



### Electric models

Your dryer has an optional cord with an equipment-grounding conductor and a grounding plug. This cord is sold separately.

The plug must be plugged into an appropriate outlet that is properly installed and grounded in accordance with all local codes and ordinances.

Do not modify the plug provided with your dryer – if it doesn't fit the outlet, have a proper outlet installed by a qualified electrician.

If a power cord is not used and the electric dryer is to be permanently wired, the dryer must be connected to a permanently grounded metal wiring system, or an equipment grounding conductor must be run with the circuit conductors and connected to the equipment grounding terminal or lead on the dryer.

# installing your dryer

---

## ELECTRICAL CONNECTIONS

---

Before operating or testing, follow all grounding instructions in the grounding section.

An individual branch (or separate) circuit serving only your dryer is recommended. **DO NOT USE AN EXTENSION CORD.**

### Gas models – U.S. and Canada

---

A 120 volt, 60 Hz AC approved electrical service, with a 15-ampere fuse or circuit breaker is required.

### Electric models – U.S. only

---

Most U.S. dryers require a 120 / 240 volt, 60 Hz AC approved electrical service. Some require 120 / 208 volt, 60 Hz approved electrical service. The electric service requirements can be found on the data label located behind the door. A 30-ampere fuse or circuit breaker on both sides of the line is required.

- If a power cord is used, the cord should be plugged into a 30-ampere receptacle.
- The power cord is NOT provided with U.S. electric model dryers.



### Risk of Electric Shock

When local codes allow, the dryer electrical supply may be connected by means of a new power supply cord kit, marked for use with a dryer, that is U.L. listed and rated at a minimum of 120/240 volts, 30-ampere with three No. 10 copper wire conductors terminated with closed loop terminals, open-end spade lugs with turned up ends, or with tinned leads.

- Do not reuse a power supply cord from an old dryer. The power cord electric supply wiring must be supported at the dryer cabinet by a suitable UL-listed strain relief.
- Grounding through the neutral conductor is prohibited for (1) new branch-circuit installations, (2) mobile homes, (3) recreational vehicles, and (4) areas where local codes prohibit grounding through the neutral conductor. (Use a 4-prong plug for a 4 wire receptacle, NEMA type 14-30R.)

### Electric models – Canada Only

---

- A 120 / 240 volt, 60 Hz AC approved electrical service fused through a 30-ampere fuse or circuit breaker on both sides of the line is required.
- All Canadian models are shipped with the power cord attached. The power cord should be plugged into a 30-ampere receptacle.





It is not permissible to convert a dryer in Canada to 208 volts.

## INSTALLATION - GENERAL PROCEDURE

**For proper installation, we recommend that you hire a qualified installer.**

Read these instructions completely before you begin the installation.

**To install the dryer, follow these steps:**

1. Move your dryer to an appropriate location for installation. Consider installing the dryer and washer side-by-side so you have easy access to both appliances.  
 To move the dryer easily, lay two of the carton cushion-tops on the floor. Tip your dryer on its side so it lies across both cushion-tops. Push the dryer so that it is near its final location. Set your dryer upright. Leave enough room around the dryer so you can attach the duct work, power cord, etc.
2. If you need to change the direction of the door, go to Door Reversal on page 20. When done, return to Step 3 below.
3. Review the exhausting section before installing the exhaust system. Install the duct work from your dryer to the exhaust hood. The crimped end of the duct sections must point away from your dryer. **DO NOT** use sheet metal screws when assembling ducting. These joints should be taped. Never use plastic flexible exhaust material.  
 A tip for tight installations: Attach a section of the exhaust system to your dryer before putting it in place. Use duct tape to secure this section to your dryer, but do not cover the ventilation slots at the back of the dryer cabinet.
4. If you have an electric model, skip to Step 6. If you have a gas model, go to the next step.
5. Review the Gas Requirements section, then follow the lettered steps below.
  - a. Remove the pipe thread protective cap.
  - b. Apply pipe joint compound or about 1 1/2 wraps of Teflon tape over all threaded connections.  
 The pipe joint compound must be resistant to the action of any liquefied petroleum gas.
  - c. Connect the gas supply to your dryer. An additional fitting is required to connect the 3/4" (1.9 cm) female thread end of a flexible connector to the 3/8" (1 cm) male threaded end on the dryer.
  - d. Securely tighten the gas line fitting over the threads.
  - e. Turn on the gas supply. Check all gas connections for leaks using a soap solution. If bubbles appear, tighten the connections and recheck. **DO NOT** use an open flame to check for gas leaks.
  - f. Go to Step 6 on the next page

# installing your dryer

6. Review the Electrical Requirements section, then follow the 3 Wire system connection instructions (Step 7) or 4 Wire system instructions (Step 8) below.

7. Three Wire system instructions:

- A. External ground connector
- B. Neutral grounding wire (green/yellow)
- C. Center silver-colored terminal block screw
- D. Neutral wire (white or center wire)
- E.  $\frac{3}{4}$ " (1.9 cm) UL-listed strain relief

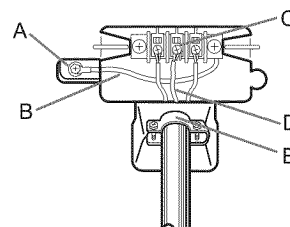

1. Loosen or remove the center terminal block screw.
2. Connect the neutral wire (white or center wire) of the power cord to the center, silver-colored terminal screw of the terminal block. Tighten screw.
3. Connect the other wires to outer terminal block screws. Tighten screws.
4. Tighten the strain relief screws.
5. Insert the tab of the terminal block cover into your dryer's rear panel slot. Secure the cover with a hold-down screw.



If converting from a 4-wire electrical system to a 3-wire, you must connect the ground strap to the terminal block support to ground the dryer frame to the neutral conductor.



We recommend using ring terminals. If you use strap terminals, please ensure you install them perfectly.

8. Four Wire System instructions:

- A. External ground connector
- B. Green or bare copper wire of power cord
- C.  $\frac{3}{4}$ " (1.9 cm) UL-listed strain relief
- D. Center silver-colored terminal block screw
- E. Neutral grounding wire (green/yellow)
- F. Neutral wire (white or center wire)

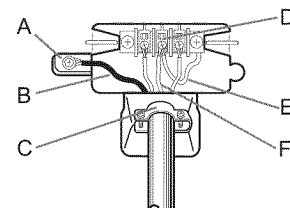

1. Remove the External ground connector screw.
2. Connect the ground wire (green or unwrapped) of the power cord to the external ground connector screw. If you want to connect B (Green or bare copper wire of power cord) to the Neutral Post without connecting it to A (cabinet ground), call a service technician.
3. Loosen or remove the center terminal block screw.
4. Connect the neutral wire (white or center wire) of the power cord and the appliance ground wire (green with yellow stripes) under the central screw of the terminal block.
5. Connect the other wires to the outer terminal block screws. Tighten screws.
6. Tighten the strain relief screws.
7. Insert the tab of the terminal block cover into your dryer's rear panel slot. Secure the cover with a hold-down screw.



We recommend using ring terminals. If you use strap terminals, please ensure you install them perfectly.

**U.S. MODELS:****Risk Of Electric Shock**

All U.S. models are designed for a 3-WIRE SYSTEM CONNECTION. The dryer frame is grounded to the neutral conductor at the terminal block. A 4-WIRE SYSTEM CONNECTION is required for new or remodeled construction, mobile homes, or if local codes do not permit grounding through neutral. If you use the 4-wire system, you cannot ground the dryer frame to the neutral conductor at the terminal block.

Remove the terminal block cover plate. Insert the power cord with a UL-listed strain relief through the hole provided in the cabinet near the terminal block.

A strain relief must be used. Do not loosen the nuts already installed on the terminal block. Be sure they are tight. Use a 3/8" (1cm) deep well socket.

9. To ensure that the dryer provides optimal drying performance, it must be level. To level the dryer, follow the lettered steps below:
  - a. Using a level, check if the dryer is level side to side and then front to back.
  - b. If the dryer is not level, adjust the leveling feet on the bottom of the dryer until the dryer is level side to side and back to front. Turning the feet clockwise retracts the feet. Turning the feet counterclockwise loosens and extends them.

**If you have a dryer and washer**

To set the dryer to the same height as the washer, fully retract the leveling feet by turning them counterclockwise, then loosen the feet by turning them clockwise. Once the dryer is the same height as the washer, follow the directions above to level the dryer.

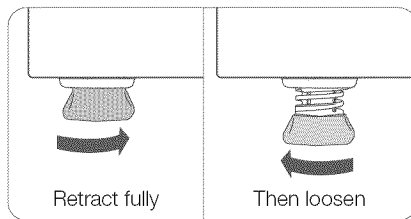

Adjust the leveling feet only as much as necessary to level the dryer. Extending the leveling feet more than necessary can cause the dryer to vibrate.

10. Make sure all gas connections (on gas models) and exhaust, and electrical connections are complete. Plug in your dryer, and then check its operation by using the checklist on the next page.
11. For GAS MODELS ONLY  
The burner may not ignite initially due to air in the gas line. Allowing your dryer to operate on a heat setting will purge the line. If the gas does not ignite within 5 minutes, turn your dryer off and wait 5 minutes. Be sure the gas supply to your dryer has been turned on. To confirm gas ignition, check the exhaust for heat.

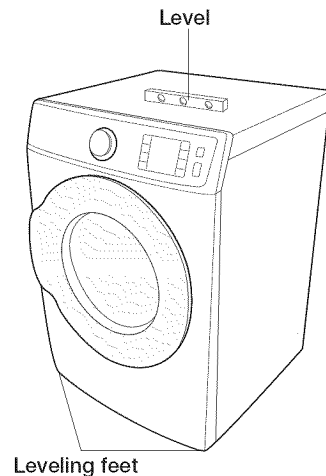

# installing your dryer

## CONNECTING THE INLET HOSE

### METHOD1

The dryer must be connected to the cold water faucet using the new inlet hoses. Do not use old hoses.

1. If space permits, attach the brass female end of the "Y" connector to the cold water faucet.
2. Turn the cold water faucet off.
3. Attach the straight end of long hose to "Y" connector.
4. Using pliers, tighten the coupling with an additional two-thirds turn.

 Do not overtighten, as it may damage the coupling.

5. Attach angled end of long hoses to fill the valve at the bottom of the dryer's rear frame. Screw on coupling by hand until it is seated on fill valve connector.

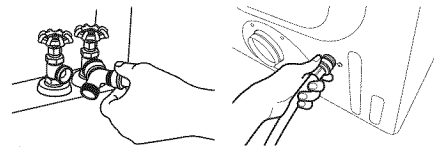

6. Using pliers, tighten the coupling with an additional two-thirds turn.

 Do not overtighten, as it may damage the coupling.

7. Check that the water faucets are on.
8. Check for leaks around "Y" connector, faucets and hoses.

### METHOD2

The dryer must be connected to the cold water faucet using the new inlet hoses. Do not use old hoses.

1. If "Y" connector cannot be attached directly to the cold water faucet, the short hose must be used.
2. Turn the cold water faucet off.
3. Attach short inlet hose to cold water faucet.

Screw on coupling by hand until it is seated on the faucet.

4. Using pliers, tighten the coupling with an additional two-thirds turn.

 Do not overtighten, as it may damage the coupling.

5. Attach "Y" connector to brass male end of small hose. Screw on coupling by hand until it is seated on connector.

6. Using pliers, tighten the coupling with an additional two-thirds turn.

 Do not overtighten, as it may damage the coupling.

7. Attach angled end of long hoses to the fill valve at the bottom of the dryer rear frame. Screw on coupling by hand until it is seated on fill valve connector.

8. Using pliers, tighten the coupling with an additional two-thirds turn.

 Do not overtighten, as it may damage the coupling.

9. Check that the water faucets are on.
10. Check for leaks around "Y" connector, faucets and hoses.

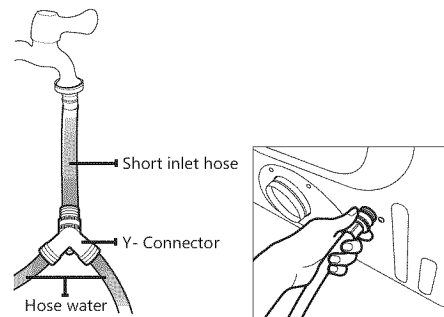

## FINAL INSTALLATION CHECK LIST

- The dryer is plugged into an electrical outlet and grounded properly.
- The exhaust ductwork is hooked up and the joints are taped.
- You have used rigid or stiff-walled flexible metal duct material, not plastic flexible duct.
- The dryer is level and is sitting firmly on the floor.
- For gas models: The gas is turned on and there are no gas leaks.
- Start your dryer to confirm that it runs, heats, and shuts off.

## DRYER EXHAUST TIPS



Plastic or non-metal flexible duct presents a potential fire hazard.

1. Make sure your dryer is installed properly so it exhausts air easily.

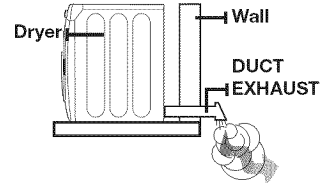

2. Use 4" diameter rigid metal duct. Tape all joints, including at the dryer.  
Never use lint-trapping screws.

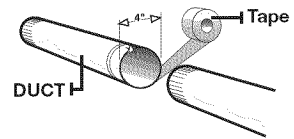

3. Keep ducts as straight as possible.

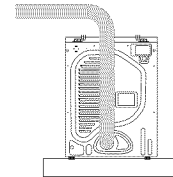

4. Clean all old ducts before installing your new dryer.  
Be sure the vent flap opens and closes freely.  
Inspect and clean the exhaust system annually.

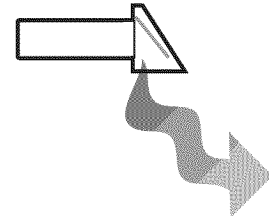

### Don't let a poor exhaust system slow drying by:

1. Restricting your dryer with a poor exhaust system.
2. Using a plastic, thin foil, or non-metal flexible duct.
3. Using unnecessarily long ducts that have many elbows.
4. Using crushed or clogged venting or ducts.

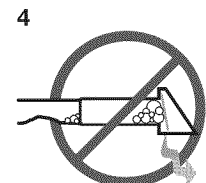
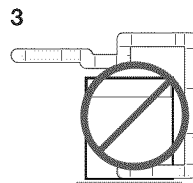
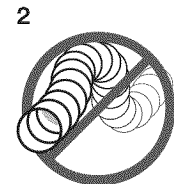
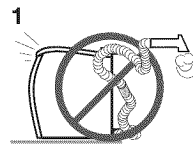

# installing your dryer

## DOOR REVERSAL

If you want to reverse the direction of the door, it is recommended calling a qualified service technician.

1. Unplug the power cord.
2. Remove the one screw from the COVER HANDLE.

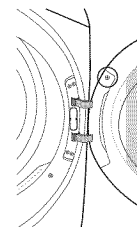

3. Remove the 7 screws (M5, M4 2type) from the BRACKET DOOR.
4. Remove DOOR from BRACKET DOOR.

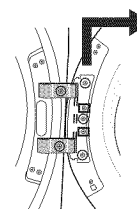

5. Remove the RING-E and PIN from the BRACKET DOOR.

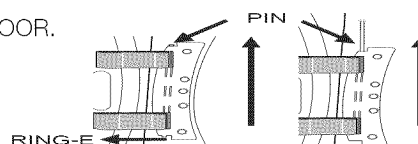

6. Remove the BRACKET DOOR from the HINGE.

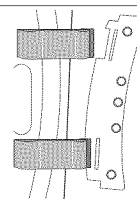

7. Remove the 4 screws (M4 2EA, M5 2EA), HOLDER LEVER, COVER HINGE, BRACKET LEVER from the left side of FRONT.



Push the COVER HINGE strongly when you disassemble screws  
**WARNING** on COVER HINGE from the left side of FRONT.

LEVER LINK will be appear by spring if you don't push COVER HINGE.

Assemble the BRACKET DOOR, PIN and RING-E on the opposite side using the PIN that were removed in Step 4.

 Use to remove COVER HOLDER LEVER With (-) driver.

8. Remove the 2 screws and COVER HOLDER LEVER from the right side of FRONT.

9. Assemble the HOLDER LEVER, COVER HINGE, BRACKET LEVER and COVER HOLDER LEVER on the opposite side using the screws that were removed from the left side in Step-7,8.

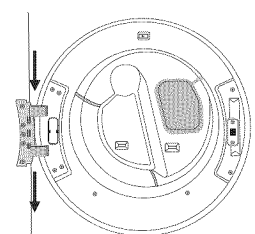
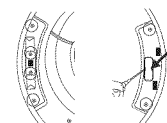
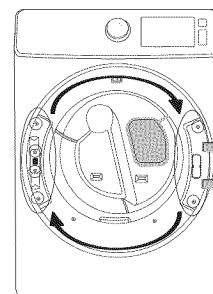

10. Remove the the 9 screws. (L12 1ea, L14 5 ea, L18 2 ea).

11. Remove the COVER HANDLE and LEVER DOOR.

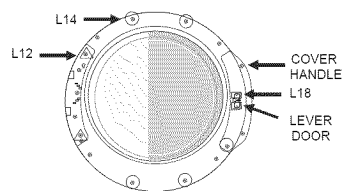

12. Remove the the 1 screw(L14).

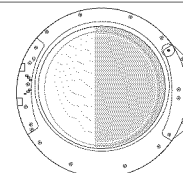

13. Rotate the HOLDER GLASS (BIG ROUNDED STEEL) 180°.

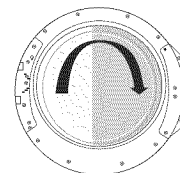

14. Assemble the the 1 screw (L14).

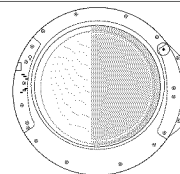

15. Assemble the COVER HANDLE and LEVER DOOR on the HOLDER GLASS.

16. Assemble the 9 screws. (L12 1ea, L14 5 ea, L18 2 ea).

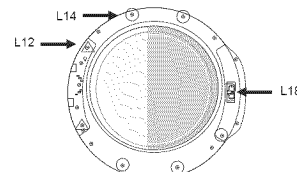

17. Install the DOOR on the 2 screws of BRACKET DOOR.

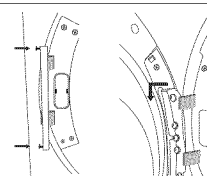

18. Fasten the 3 screws that removed in step 3.

 Check position of screw that installed to bracket door.

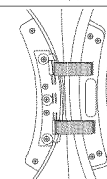

19. Install the COVER HOLDER on the HOLDER GLASS and then Fasten the 1 screws that removed in step 1.

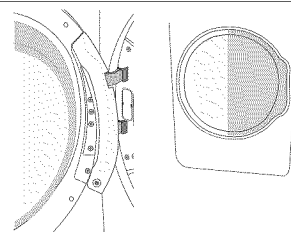

# operating instructions, tips

**WARNING** To reduce the risk of fire, electric shock, or injury to persons, read the IMPORTANT SAFETY INSTRUCTIONS before operating this appliance.

## OVERVIEW OF THE CONTROL PANEL

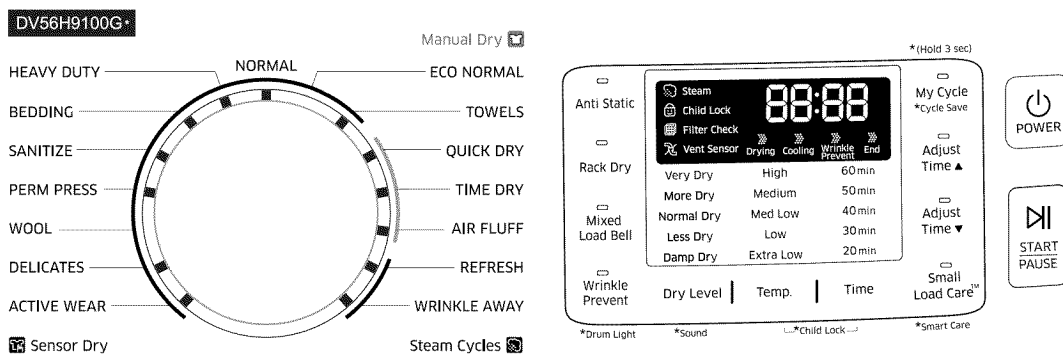
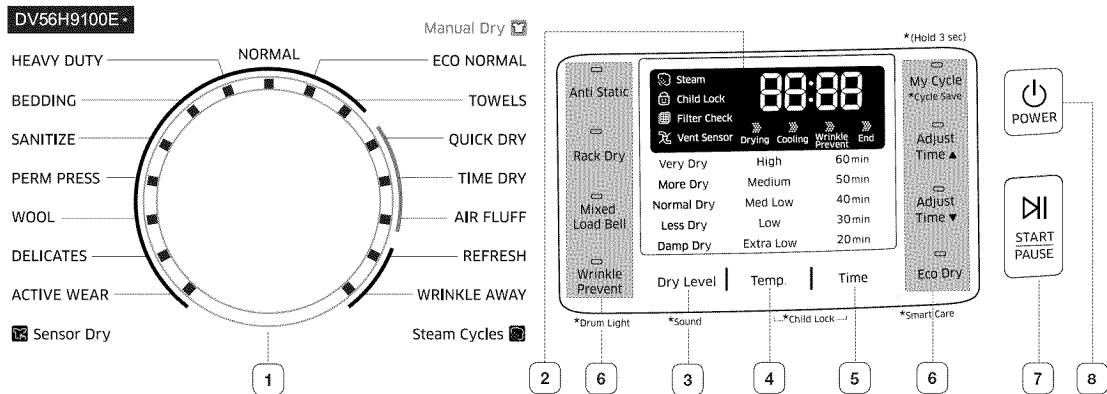

### 1 Cycle Selector

To select a cycle, rotate the Cycle Selector dial to the desired cycle. The indicator light by the cycle name will illuminate. The NORMAL, HEAVY DUTY, BEDDING, SANITIZE, PERM PRESS, WOOL, DELICATES, ACTIVE WEAR, ECO NORMAL, and TOWELS cycles are Sensor Dry cycles. Sensor Dry automatically senses the moisture in the load and shuts the dryer off when the load reaches the dryness level you have selected with the Dry Level Selection Button (see below).

**ECO NORMAL** - For reducing energy usage. This cycle adjusts cycle time and temperature for increased efficiency.

**NORMAL** - The normal cycle is for most fabrics including cotton, linens, and normally soiled garments.

(If this cycle is selected, the Eco Dry function is enabled by default. For more information, please refer to the descriptions about the "Eco Dry" option.)

**HEAVY DUTY** - Use this cycle to get high heat for heavy fabrics such as jeans, corduroys, or work clothes.

**BEDDING** - For bulky items such as blankets, sheets and comforters.

**SANITIZE** - Sanitizes garments by infusing high temperature heat deep into the fabric during the drying cycle. Use this cycle to keep your bedding and curtains clean through sanitization.

**PERM PRESS** - Dry wrinkle-free cottons, synthetic fabrics, knits, and permanent press fabrics automatically.



	<p><b>WOOL</b> - For machine washable and tumble dryable wool only.</p> <p><b>DELICATES</b> - The DELICATES cycle is designed to dry heat-sensitive items at a low drying temperature.</p> <p><b>ACTIVE WEAR</b> - The ACTIVE WEAR cycle is for exercise wear and outdoor wear such as sports jerseys, training pants, water-repellent jackets and other performance clothing. Thick fabrics like a zipper or velcro closure of a jacket, or training socks may not be completely dried.</p> <p><b>TOWELS</b> - To dry bath towels and similar items.</p> <p><b>QUICK DRY</b> - Provides a 30 minute drying cycle.</p> <p><b>TIME DRY</b> - The TIME DRY cycle allows you to select a cycle time in minutes. (If this cycle is selected, the Eco Dry function is enabled by default. For more information, please refer to the descriptions about the "Eco Dry" option.)</p> <p><b>AIR FLUFF</b> - The AIR FLUFF cycle tumbles the load in room temperature air.</p> <p><b>REFRESH</b> - This cycle is best for smoothing out wrinkles and reducing odors from loads consisting of one to four dry items. In this cycle a small amount of water is sprayed into the dryer drum after several minutes of tumbling with heat.</p> <p><b>WRINKLE AWAY</b> - The WRINKLE AWAY cycle removes wrinkles from clothes stored in closets, etc. It provides wrinkle release via optimized steam care. You can change the drying time. (Minimum time : 20 minutes)</p> <p>* For best results, load no more than 3 items.</p>
<p>2 <b>Digital Graphic Display</b></p>	<p>The display window shows the estimated time remaining in the cycle after you have pressed the Start/Pause button. The estimated time remaining may fluctuate as the cycle progresses.</p> <p>The Drying light will illuminate and remain lit until the cycle is complete. When your dryer is in the cool-down phase, the Cooling light will illuminate. When your dryer is in the wrinkle prevent phase, the Wrinkle Prevent light will illuminate. When the cycle is complete, "End" will appear in the display panel until you push the Start/Pause button or the power button. If your dryer is paused during a cycle, the indicator lights will blink until you press the Start/Pause button.</p>
<p>3 <b>Dry Level Selection Button</b></p>	<p>To select the dry level in the NORMAL, HEAVY DUTY, or other Sensor Dry cycles except SANITIZE, WOOL and ACTIVE WEAR press the Dry Level button. An indicator light will illuminate next to the desired dryness level. Press the button repeatedly to scroll through the settings. Larger or bulkier loads may require the Very Dry or More Dry setting for complete dryness. The Less Dry setting is best suited for lightweight fabrics or for leaving some moisture in the clothing at the end of the cycle. Damp Dry is designed to partially dry items. Use for items that lay flat or hang to dry.</p>
<p>4 <b>Temp. Selection Button</b></p>	<p>To select the temperature for the load, press the Temp. button. An indicator light will illuminate next to the temperature you selected. Press the button repeatedly to scroll through the settings.</p> <p><b>High</b> - For sturdy cottons or those labeled Tumble Dry.</p> <p><b>Medium</b> - For permanent press, synthetics, lightweight cottons, or items labeled Tumble Dry Medium.</p> <p><b>Med Low</b> - For heat lower than Medium. Use to dry synthetic or washable knit fabrics.</p> <p><b>Low</b> - For heat sensitive items labeled Tumble Dry Low or Tumble Dry Warm.</p> <p><b>Extra Low</b> - Provides the lowest heated drying temperature possible.</p>
<p>5 <b>Time Selection Button</b></p>	<p>When using Manual Dry cycles, you can adjust the drying time by pressing the time selection button.</p> <p>During the Sensory Dry cycle, the time light indicator is off because exact drying times are determined by fluctuating humidity levels. Therefore, the actual drying time may differ from the displayed time.</p>

# operating instructions, tips

<p><b>6 Select Cycle Option</b></p>	<p><b>Anti Static</b> - To reduce statics by clothing friction and spray steam at the later period of drying cycle. It is only available with: NORMAL, HEAVY DUTY, PERM PRESS, DELICATES (Dry level of every cycle exceeds Normal) and TIME DRY cycle.</p> <p><b>Rack Dry</b> - Rack Dry is available in the TIME DRY cycle. Temperature will be set to Extra Low only. (Refer to the "Rack Dry" section on page 25.)</p> <p><b>Mixed Load Bell</b> - The mixed load bell that notifies you when the average dry level in a load is damp dry (80% dried). This lets you take garments that you don't want fully dried or that dry quickly out of the dryer early while letting others continue to dry. You can select this function in all Sensor Dry cycles except WOOL, SANITIZE and ACTIVE WEAR. The dry level selections are limited to Normal Dry, More Dry, and Very Dry.</p> <p><b>Wrinkle Prevent</b> - Wrinkle Prevent provides approximately 180 minutes of intermittent tumbling in unheated air at the end of the cycle to reduce wrinkling. Press the Wrinkle Prevent button to activate this feature. The indicator light above the pad will illuminate when Wrinkle Prevent is selected. The load is dry, and can be removed at any time during the Wrinkle Prevent cycle.</p> <p><b>My Cycle</b> - Choose your favorite cycle including cycle, temp, dry level option, etc. (Refer to the "My cycle" section on page 26.)</p> <p><b>Adjust Time</b> - Time can be added or subtracted from the automatically set times in the Manual Dry cycles (TIME DRY, QUICK DRY, or AIR FLUFF cycles) and WRINKLE AWAY cycle. To add or subtract time from the cycle, press the Adjust Time arrow pad up or down until the desired time is displayed.</p> <p><b>Small Load Care™ (Gas model Only)</b> - To control the operation rate for drying a small load in the Sensor Dry cycle. It is only available with: NORMAL, HEAVY DUTY, PERM PRESS and DELICATES cycle. It can't be selected/cancelled when the drying cycle is running. In order to improve drying effect and control operation rate, the drum can be paused during operation.</p> <p><b>Eco Dry (Electric model Only)</b> - This function is available in the NORMAL, and TIME DRY cycles. When the Eco Dry function is activated, drying takes longer but the power consumption is reduced. (When the Eco Dry function is enabled, the drying time can be extended up to 3 times depending on the specified temperature and the amount of laundry to be dried. When the product is shipped, the Eco Dry function is set to On by default.)</p>
<p><b>7 Start/Pause selection button</b></p>	<p>Press to pause and restart programs.</p>
<p><b>8 Power button</b></p>	<p>Press once to turn your dryer on, Press again to turn it off. If you turn your dryer on and do not touch any buttons for 10 minutes, the power automatically turns off.</p>

 If you insert laundry into your dryer while it is extremely tangled immediately after your washer has finished a wash or spin cycle, it may degrade the drying efficiency or cause the door to open. We recommend that you disentangle your laundry appropriately before inserting it.

 Each indicator on the graphic display means:

	Steam
	Child Lock
	Filter Check
	Vent Sensor

## RACK DRY

### Using the drying rack

1. The drying rack is installed in the drum at in default state.
2. When using this dryer for the first time, remove the drying rack from the drum. Pull upwards vertically and take the drying rack out of the drum. Remove the package and keep it properly stored.
3. When you need to use drying rack, refer to the following steps for installation.

### Installing the drying rack

1. Open the dryer door.
2. Place the Drying Rack inside the product, and then align the holes of the filter handle of the Drying Rack to the front projections.
3. Place the rear legs in the two recessed areas of the dryer's back wall, and then push down the middle of the drying rack to fix it in place.
4. Place the items to be dried on the rack, leaving space between them so air can circulate.
5. Close the dryer door.
6. Press the RACK DRY button in Time Dry cycle, and then select the time according to the moisture and weight of item.

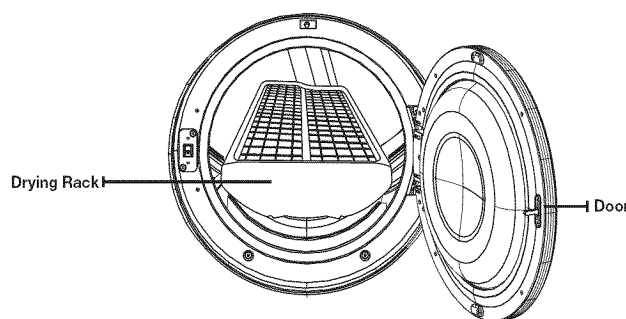

-  Place the Drying Rack inside the dryer, align the holes of the filter handle of the Drying Rack with the front projections, and then secure the back of the Drying Rack.

SUGGESTED ITEMS	SUGGESTED TEMP. SETTINGS
Washable sweaters (block to shape and lay flat on rack)	Extra Low (Time Dry cycle)
Stuffed toys (cotton or polyester fiberfilled)	Extra Low (Time Dry cycle)
Stuffed toys (foam or rubber-filled)	Air Fluff
Foam rubber pillows	Air Fluff
Sneakers	Air Fluff

-  Don't dry the drying rack together with the package when using the drying rack.
- WARNING** Drying foam rubber, plastic, or rubber on a heat setting may cause damage to the items and create a fire hazard.

-  In case this model is not supplied with a Drying Rack, you can purchase it through a service center.

# operating instructions, tips

---

## MY CYCLE

---

Allows you to activate your custom dry (Cycle, Dry Level, Temp) with one button convenience. Press the **My Cycle** button to load and use the saved My Cycle options. The "My Cycle" light will indicate activation. Also, the chosen course and option lights will flicker.

You can set options as follows in the My Cycle mode.

1. Press the **Power** button.
2. Select cycle using the **Cycle Selector**.
3. After cycle selection, set each option (Dry Level, Temp, Time)
4. You can then store the selected cycle and options by pressing and holding the My Cycle button for longer than 3 seconds in My Cycle mode. The cycle and options you select will be displayed the next time you choose the My Cycle function.

 You can change the My Cycle settings by repeating the same process above.  
The last used setting will be displayed the next time you choose the My Cycle function.

 If you press My Cycle and release it within 3 seconds, the previously saved cycle and options appear.  
If you press and hold My Cycle for 3 second or longer, the currently set cycle and options are saved and the LED blinks for 3 seconds.

## DRUM LIGHT

---

Lights the dryer drum while the dryer is running.

### Turning On and Off

---

Press and hold the Wrinkle Prevent button for 3 seconds or more.

 You can turn the Drum Light on and off while your dryer is running and when it is stopped.  
If you do not turn the Drum Light off 5 minutes after turning it on, the Drum Light automatically turns off.

## SOUND

---

The Sound Off function can be selected during all cycles.

### Activating

---

If you want to activate the Sound Off function, press the Dry Level button at the same time for 3 seconds.

### Deactivating

---

If you want to deactivate the Sound Off function, press the Dry Level button at the same time for 3 seconds again.

 When this function is selected, sound is turned off for all cycles.  
Even if the power is turned on and off repeatedly, the setting is retained.

## CHILD LOCK

---

Prevents children from playing with your dryer.

### Setting/Releasing

---

If you want to set or release the Child Lock, press the Temp. and Time buttons simultaneously for 3 seconds.

### Child Lock Details

- You can turn Child Lock on while your dryer is running.
- Once you turn Child Lock on, no button, except for the power button, will respond until you turn off the Child Lock function.
- The Child Lock indicator will be lit.

 If you have not turned off Child Lock, and then turned the dryer off and on, the Child Lock function will still be on. To turn off Child Lock, follow the instructions above.

 When other buttons, except for the power button, do not respond, check the Child Lock indicator. If Child Lock is on, follow the instructions above to turn Child Lock off.

## SMART CARE

This function enables you to check the status of the dryer using a smartphone.

1. To enable the Smart Care function, press the power button to turn the dryer on and then press and hold the Time button for 3 seconds. If you press a button other than the Time button after turning the dryer on, you will not be able to activate the Smart Care function.
  - The error code history is deleted after using the function.
2. If the Smart Care function is activated, the Smart Care indicator is lit on the display.
3. Run the Smart Care app on your smart phone.
  - GalaxyS, GalaxyS2, GalaxyS3, GalaxyS4, GalaxyS2(HD), Galaxy Note, Galaxy Note2, Galaxy Note3 (Other devices may not be normal operation).  
Supported operating system: Android 2.2 or higher.
  - iPhone 3 G S, iPhone 4/4S, iPhone 5/5S.  
Supported operating system : OS 4.3 or higher.
4. Focus the smart phone's camera on the display panel of the dryer.
5. If the smart phone's camera is focused on the display panel of the dryer, the panel and error message is automatically recognized and the error type and countermeasures are displayed on the smart phone.
6. If the smartphone fails to recognize the error code more than twice, please enter the error code displayed on the display panel of the dryer manually into the Smart Care app.

 Downloading the Smart Care app

- Download the Samsung Laundry App into your mobile phone from the Android market or Apple App store. (Search word : Samsung Smart Washer/Dryer)

 Precautions when using Smart Care

- If light from a light bulb, fluorescent bulb, or lamp is reflected on the display panel of the dryer, the smartphone may not be able to recognize the panel or error message easily.
- If you hold the smartphone at too large an angle relative to the front of the display panel, it may not be able to recognize the error code. For best results, hold the smartphone so that the front of the panel and the smartphone are parallel or nearly parallel.

# operating instructions, tips

## CLEAN THE LINT FILTER

- After or before each load.
- To shorten drying time.
- To operate more energy efficiently.

 Do not operate your dryer without the lint filter in place.

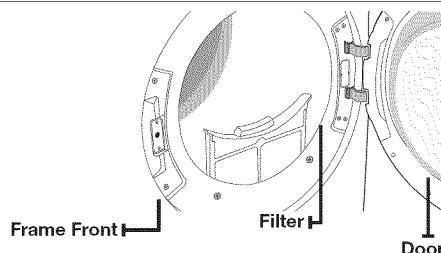



## LOAD THE DRYER PROPERLY

- Place only one washload in your dryer at a time.
- In mixed loads, heavy and lightweight fabrics will dry differently. This may result in lightweight fabrics being dry while heavy fabrics remain damp at the end of a drying cycle.
- Add one or more additional similar items to your dryer when you are drying only one or two items. This improves the tumbling action and drying efficiency.
- Overloading restricts tumbling action, resulting in uneven drying as well as excessive wrinkling of some fabrics.

## GETTING STARTED

1. Load your dryer loosely – DO NOT overload.
2. Close the door.
3. Select the appropriate cycle and options for the load ( See pages “Cycle Chart” ).
4. Press the Start/Pause button.
5. The dryer indicator light will illuminate.
6. The estimated cycle time will appear in the display.  
The time may fluctuate as humidity levels fluctuate in the dryer.

-  • When the cycle is complete, “End” will appear in the display.
- Pressing power cancels the cycle and stops your dryer.
  - The Drying, Cooling, and Wrinkle Prevent indicator lights will illuminate during those portions of the cycle.



 **WARNING** Do not place anything on top of your dryer while it is running.

## VENT SENSOR

Your Samsung dryer is equipped with a Vent Sensor, which detects and notifies you when it is time to clean the ductwork. Keep your dryer safe and efficient by cleaning the ducts when prompted.

### The Vent Sensor detects any duct blockages

You can figure out whether there is a duct blockage from the “Vent Sensor ” lamp of the digital display.

Level	Message	Status	Solution
0	The "Vent Sensor  " lamp is turned off.	The ductwork is free from blockages.	-
1	The "Vent Sensor  " lamp illuminates.	When a part of the duct or the lint filter is blocked by lint or a foreign object. When the resistance is high because the duct is too long or bent.	Check the duct connection and shorten the duct and straighten it if necessary. Check the lint filter or the duct and clean it if necessary.
2	The "Vent Sensor  " lamp blinks.	When the duct is blocked by lint or a foreign object. When the resistance is very high because the duct is too long or bent excessively.	Check the duct connection and shorten the duct and straighten it if necessary. Check the lint filter or the duct and clean it as soon as possible.

In the LEVEL 2 state, this lamp blinks for 3 hours after the completion of the cycle. (If the wrinkle prevention function is activated, this message is displayed for up to 3 hours.)

If the power button is pressed or the door is opened, the power is immediately turned off.

 For more information about the duct installation, please refer to the "Ducting requirements" section on page 8.

- Although the dryer is available even if the blockage message is displayed, the drying time may be extended.
- If the LEVEL 1 message is displayed the first time the dryer is run after the installation, check the connection and clean the duct. If the LEVEL 1 message appears even after you have checked and cleaned the ducts, this may indicate that there are some restrictions of the duct due to the length, condition, etc.  
If this occurs, you can use the dryer normally and no countermeasures need to be taken. However, the drying time may be extended or the drying performance may be degraded.

# care and cleaning

---

## **CONTROL PANEL**

---

Clean with a soft, damp cloth. Do not use abrasive substances.

Do not spray cleaners directly on the panel.

The control panel finish may be damaged by some laundry pre-treatment soil and stain remover products. Apply such products away from your dryer and wipe up any spills or overspray immediately.

## **TUMBLER**

---

Remove any stains from the tumbler caused by crayon, ink, fabric dye (from new items such as towels or jeans) and so on with an all-purpose cleaner.

Tumble old towels or rags to remove any remaining stain or cleaning substance.

Once these steps are followed, stains may still be visible, but should not transfer to subsequent loads.

## **POWDER COATED TUMBLER**

---

To clean the powder coated tumbler, use a damp cloth with a mild, non-abrasive cleaner suitable easily marred surfaces.

Remove cleaner residue and dry with a clean cloth.

## **DRYER EXTERIOR**

---

Clean with a soft, damp cloth. Do not use abrasive substances.

Protect the surface from sharp objects.

Do not place any heavy or sharp objects or a detergent box on the dryer. They can scratch or damage the top cover of the dryer. Keep these items in the separately purchased pedestal or in a separate storage box. The entire dryer has a high-gloss finish. Avoid scratching or damaging the surface when using the dryer.

## **DRYER EXHAUST SYSTEM**

---

Inspect and clean the dryer exhaust system yearly to maintain optimum performance.

The outside exhaust hood should be cleaned more frequently to ensure proper operation.

# special laundry tips

## Special laundry tips

Please follow the care label or manufacturer's instructions for drying special items. If care label instructions are not available, use the following information as a guide.

<b>Bedspreads &amp; Comforters</b>	<ul style="list-style-type: none"><li>• Follow the care label instructions or dry using the Bedding cycle.</li><li>• Make sure the item is thoroughly dry before using or storing.</li><li>• May require repositioning to ensure even drying.</li></ul>
<b>Blankets</b>	<ul style="list-style-type: none"><li>• Use the Normal cycle and dry only one blanket at a time for best tumbling action.</li><li>• Make sure the item is thoroughly dry before using or storing.</li></ul>
<b>Curtains &amp; Draperies</b>	<ul style="list-style-type: none"><li>• Use the Perm Press cycle and medium temperature to help minimize wrinkling.</li><li>• Dry these in small loads for best results and remove as soon as possible.</li></ul>
<b>Cloth Diapers</b>	<ul style="list-style-type: none"><li>• Use the Normal cycle and the High temperature settings for soft, fluffy diapers.</li></ul>
<b>Down-filled Items (jackets, sleeping bags, comforters, etc.)</b>	<ul style="list-style-type: none"><li>• Use the Normal cycle and medium temperature setting.</li><li>• Adding a couple of dry towels shortens drying time and absorbs moisture.</li></ul>
<b>Foam Rubber (rug backs, stuffed toys, shoulder pads, etc.)</b>	<ul style="list-style-type: none"><li>• DO NOT dry on a heat setting. Use the Air Fluff cycle</li><li>• WARNING – Drying a rubber item with heat may damage it or create a fire hazard.</li></ul>
<b>Pillows</b>	<ul style="list-style-type: none"><li>• Use the Normal cycle.</li><li>• Add a couple of dry towels and a pair of clean sneakers to help the tumbling action and to fluff the items.</li><li>• DO NOT dry kapok or foam pillows in the dryer. You can dry these items in the dryer only if you use the Air Fluff cycle.</li></ul>
<b>Plastics (shower curtains, outdoor furniture covers, etc.)</b>	<ul style="list-style-type: none"><li>• Use the Air Fluff cycle or the Time Dry cycle and the Low or Extra Low temperature settings depending on the care label instructions.</li></ul>

### THINGS TO AVOID PUTTING IN THE DRYER :

- Fiberglass items (curtains, draperies, etc.).
- Woolens, unless recommended on the label.
- Items spotted or soaked with vegetable or cooking oils.

# troubleshooting

## CHECK THESE POINTS IF YOUR DRYER...

PROBLEM	SOLUTION
<b>Doesn't run.</b>	<ul style="list-style-type: none"> <li>• Make sure the door is latched shut.</li> <li>• Be sure the power cord is plugged into a live electrical outlet.</li> <li>• Check your home's circuit breakers or fuses.</li> <li>• Press the Start/Pause button again if the door is opened during the cycle.</li> </ul>
<b>Doesn't heat.</b>	<ul style="list-style-type: none"> <li>• Check your home's circuit breakers or fuses.</li> <li>• Select a heat setting other than Air Fluff.</li> <li>• On a gas dryer, check that the gas supply is on.</li> <li>• Clean the lint filter and exhaust duct.</li> <li>• Dryer may have moved into the cool-down phase of the cycle.</li> </ul>
<b>Doesn't dry.</b>	<ul style="list-style-type: none"> <li>• Check all of the above, plus...</li> <li>• Be sure the exhaust hood outside the home can open and close freely.</li> <li>• Check the exhaust system for lint buildup. Ducting should be inspected and cleaned annually.</li> <li>• Use a 4" rigid metal exhaust duct.</li> <li>• Do not overload. 1 wash load = 1 dryer load.</li> <li>• Sort heavy items from lightweight items.</li> <li>• Large, bulky items like blankets or comforters may require repositioning to ensure even drying.</li> <li>• Check that the washer is draining properly to extract adequate water from the load.</li> <li>• Load may be too small to tumble properly. Add a few towels.</li> </ul>
<b>Is noisy.</b>	<ul style="list-style-type: none"> <li>• Check the load for objects such as coins, loose buttons, nails, etc. Remove promptly.</li> <li>• It is normal to hear the dryer gas valve or heating element cycle on and off during the drying cycle.</li> <li>• Be sure the dryer is leveled properly as outlined in the installation instruction.</li> <li>• It is normal for the dryer to hum due to the high velocity of air moving through the dryer drum and exhaust system.</li> </ul>
<b>Dries unevenly.</b>	<ul style="list-style-type: none"> <li>• Seams, pockets, and other similarly heavy areas may not be completely dry when the rest of the load has reached the selected dryness level. This is normal. Select the Very Dry setting if desired.</li> <li>• If one heavy item is dried with a lightweight load, such as one towel with sheets, it is possible that the heavy item will not be completely dry when the rest of the load has reached the selected dryness level. Sort heavy items from lightweight items for best drying results.</li> </ul>
<b>Has an odor.</b>	<ul style="list-style-type: none"> <li>• Household odors from paint, varnish, strong cleaners, etc. may enter the dryer with the surrounding room air. This is normal as the dryer draws the air from the room, heats it, pulls it through the tumbler, and exhausts it outside.</li> <li>• When these odors linger in the air, ventilate the room completely before using the dryer.</li> </ul>

PROBLEM	SOLUTION
<b>Shuts off before load is dry</b>	<ul style="list-style-type: none"> <li>The dryer load is too small. Add more items or a few towels and restart the cycle.</li> <li>The dryer load is too large. Remove some items and restart the dryer.</li> </ul>
<b>Lint on clothes</b>	<ul style="list-style-type: none"> <li>Make sure the lint filter is cleaned before every load. With some loads that produce high amounts of lint, it may be necessary to clean the filter during the cycle.</li> <li>Some fabrics are lint producers (for example, a fuzzy white cotton towel) and they should be dried separately from clothes that are lint trappers (for example, a pair of black linen pants).</li> <li>Divide larger loads into smaller loads for drying.</li> <li>Check pockets thoroughly before washing and drying clothes.</li> </ul>
<b>Garments still wrinkled after Wrinkle Release</b>	<ul style="list-style-type: none"> <li>Small loads of 1 to 4 items work best.</li> <li>Load fewer garments. Load similar-type garments.</li> </ul>
<b>Odors remain in clothing after Air Fluff.</b>	<ul style="list-style-type: none"> <li>Fabrics containing strong odors should be washed in a normal cycle.</li> </ul>

## INFORMATION CODES

Information codes may be displayed to help you understand what is occurring with your dryer better.



































ERROR DISPLAY	MEANING	SOLUTION
<b>tE</b>	The thermistor resistance is very low or high.	Clean the screen or vent. If the problem continues, call for service.
<b>HE</b>	Invalid heating Temp when the dryer is running.	Call for service.
<b>dE</b>	Running the dryer with door open.	Close the door and then restart. If the problem continues, call for service.
<b>FE</b>	Invalid power source frequency.	Try restarting the cycle. If the problem continues, call for service.
<b>9E1</b>	Electronic Control Problem. (Over Voltage Error)	Call for service.
<b>AE</b>	Electronic Control Problem. (Communication Error)	Call for service.
<b>EEE</b>	Invalid state of Eeprom Communication.	Call for service.
<b>dF</b>	Invalid door.	Call for service.
<b>bE2</b>	Unit detects a button is being pressed for over 30secs or button is stuck.	Make sure a button is NOT being pressed continuously. Try restarting the cycle. If the problem continues, call for service.

For any codes not listed above, call 1-800-726-7864 (1-800-SAMSUNG)

# appendix

## FABRIC CARE CHART

The following symbols provide garment care directions. The Clothing care labels include symbols for washing, bleaching, drying and ironing, or dry cleaning when necessary. The use of symbols ensures consistency among garment manufacturers of domestic and imported items. Follow care label directions to optimize garment life and reduce laundering problems.

Wash Cycle		Special Instructions		Warning Symbols for Laundering	
	Normal		Line Dry/ Hang to Dry		Do Not Wash
	Permanent Press / Wrinkle Resistant / Wrinkle Control		Drip Dry		Do Not Wring
	Gentle/Delicates		Dry Flat		Do Not Bleach
	Hand Wash	<b>Heat Setting</b>			Do Not Tumble Dry
<b>Water Temperature**</b>			High		No Steam (added to iron)
	Hot		Medium		Do Not Iron
	Warm		Low	<b>Dryclean</b>	
	Cold		Any Heat		Dry Clean
<b>Bleach</b>			No Heat/Air		Do Not Dry Clean
	Any Bleach (when needed)	<b>Iron-Dry or Steam Temperatures</b>			Line Dry/ Hang to Dry
	Only Non-Chlorine (color-safe) Bleach (when needed)		High		Drip Dry
	Tumble Dry Cycle		Medium		Dry Flat
<b>Normal</b>			Low		
	Permanent Press/ Wrinkle Resistant/ Wrinkle Control				
	Gentle/ Delicates				

\*\* The dot symbols represent appropriate wash water temperatures for various items. The temperature range for Hot is 105° – 125 °F / 41° – 52 °C, for Warm 85° – 105 °F / 29° – 41 °C and for Cold 60° – 85 °F / 16° – 29 °C. (Wash water temperature must be a minimum of 60° F/16° C for detergent activation and effective cleaning.)

## PROTECTING THE ENVIRONMENT

This appliance is manufactured from recyclable materials. If you decide to dispose of this appliance, please observe local waste disposal regulations. Cut off the power cord so that the appliance cannot be connected to a power source. Remove the door so that animals and small children cannot get trapped inside the appliance.

## DECLARATION OF CONFORMITY

This appliance complies with UL2158.

## SPECIFICATIONS

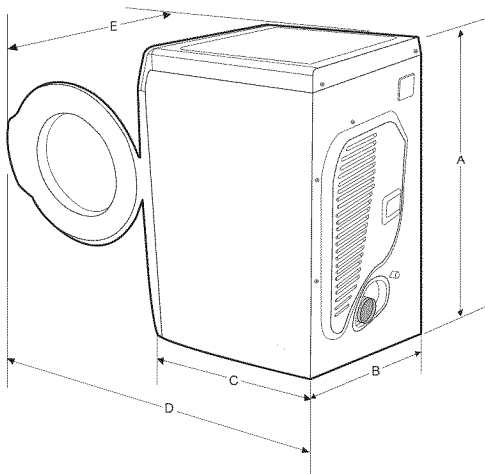

Type	FRONT LOADING DRYER					
DIMENSIONS	Div		Inches (mm)	Div		Inches (mm)
	A. Height	Product	42.6" (1083)	C. Depth	Product	32" (813)
		Install	44.6"		Install	37"
	B. Width	Product	30" (762)	D. Depth with door open 90°	Product	57.8" (1467)
		Install	32"		Install	62.8"
	E. Width with door open 120°	Product	53.7" (1364)			
Install		58.7"				
WATER PRESSURE	20-116 psi (137-800 kPa)					
WEIGHT	158.7 lb (72 kg)					
HEATER RATING	5300 W (Elec.) 22000 BTU/hr (Gas)					

# CYCLE CHART

DV56H9100E(G)\*

(● : factory setting, ● : selectable)

Cycle	Recommended Item	Load Size	Functions
			Sensor Dry Level
Sensor Dry	ECO NORMAL	Cottons, Work clothes, Linen	Normal Dry (Adjustable)
	NORMAL	Cottons, Work clothes, Linen, Mixed Loads	Normal Dry (Adjustable)
	HEAVY DUTY	Heavy Fabrics such as jean, corduroys, heavy work clothes	Normal Dry (Adjustable)
	BEDDING	Bulky items such as blankets, Sheets, Comforters, Pillows	Normal Dry (Adjustable)
	SANITIZE	Bedding, Curtains, Children's clothing	Very Dry (No change)
	PERM PRESS	Shirts, Synthetic Fabrics, Knits, Wrinkle-free cottons, Permanent	Normal Dry (Adjustable)
	WOOL	For machine washable and tumble dryable wool only (Maximum amount : 3lb)	Normal Dry (No change)
	DELICATES	Underwear, Blouses, Lingerie	Normal Dry (Adjustable)
	ACTIVE WEAR	Water-repellent wear, performance clothes, Sports wear (Maximum amount : 4lb)	Normal Dry (No change)
	TOWELS	Bath towels and similar items	Normal Dry (Adjustable)
Manual Dry	QUICK DRY	Small loads	-
	TIME DRY	Any load	-
	AIR FLUFF	Foam, Rubber, Plastic	-
Steam Cycles	REFRESH	Shirts, Trouser, Comforter, Pillows	-
	WRINKLE AWAY	Shirts, Trouser, Blouses	-

Cycle		Functions					Options						
		Temp. Control					Time	Mixed Load Bell	Adjust Time Up/Down	Eco Dry	Small Load Care™	Anti Static	Wrinkle Prevent
		High	Medium	Med Low	Low	Extra Low							
Sensor Dry	ECO NORMAL					●		●					●
	NORMAL	●	●					●		●	●	●	●
	HEAVY DUTY	●						●			●	●	●
	BEDDING	●						●					●
	SANITIZE	●											●
	PERM PRESS		●					●			●	●	●
	WOOL				●								●
	DELICATES					●		●			●	●	●
	ACTIVE WEAR		●										●
	TOWELS	●	●					●					●
Manual Dry	QUICK DRY	●						●					●
	TIME DRY	●	●	●	●	●		●	●	●	●	●	●
	AIR FLUFF							●					●
Steam Cycles	REFRESH	●											●
	WRINKLE AWAY	●						●					●

Eco Dry : Elec. Model Only

Small Load Care™ : Gas model Only

## Load Size Recommendations



**Large load** : Fill the drum to about ¾ full. Do not add items over this level as they need to tumble freely.



**Medium load** : Fill the drum to about ½ full.



**Small load** : Fill the drum with 3~5 items, not more than ¼ full.

\* For best results, follow the load size recommendations for each dry cycle.

# warranty (U.S.A)

---

## **SAMSUNG DRYER**

### **LIMITED WARRANTY TO ORIGINAL PURCHASER**

This SAMSUNG brand product, as supplied and distributed by SAMSUNG ELECTRONICS AMERICA, INC. (SAMSUNG) and delivered new, in the original carton to the original consumer purchaser, is warranted by SAMSUNG against manufacturing defects in materials and workmanship for a limited warranty period of:

One (1) Year All Parts and Labor

Two (2) Years Control Board Parts (Part Only)

This limited warranty begins on the original date of purchase, and is valid only on products purchased and used in the United States.

To receive warranty service, the purchaser must contact SAMSUNG for problem determination and service procedures.

Warranty service can only be performed by a SAMSUNG authorized service center.

The original dated bill of sale must be presented upon request as proof of purchase to SAMSUNG or SAMSUNG's authorized service center.

SAMSUNG will provide in-home service during the warranty period at no charge, subject to availability within the contiguous United States.

In-home service is not available in all areas.

To receive in-home service, product must be unobstructed and accessible to the service agent.

If service is not available, SAMSUNG may elect to provide transportation of the product to and from an authorized service center.

SAMSUNG will repair, replace, or refund this product at our option and at no charge as stipulated herein, with new or reconditioned parts or products if found to be defective during the limited warranty period specified above.

All replaced parts and products become the property of SAMSUNG and must be returned to SAMSUNG. Replacement parts and products assume the remaining original warranty, or ninety (90) days, whichever is longer.

This limited warranty covers manufacturing defects in materials and workmanship encountered in normal, noncommercial use of this product and shall not apply to the following: damage that occurs in shipment; delivery and installation; applications and uses for which this product was not intended; altered product or serial numbers; cosmetic damage or exterior finish; accidents, abuse, neglect, fire, water, lightning, or other acts of nature or God; use of products, equipment, systems, utilities, services, parts, supplies, accessories, applications, installations, repairs, external wiring or connectors not supplied or authorized by SAMSUNG that damage this product or result in service problems; incorrect electrical line voltage, fluctuations and surges; customer adjustments and failure to follow operating instructions, maintenance and environmental instructions that are covered and prescribed in the instruction book; product removal and reinstallation; problems caused by pest infestations.

This limited warranty does not cover problems resulting from incorrect electric current, voltage or supply, light bulbs, house fuses, house wiring, cost of a service call for instructions, or fixing installation errors.

SAMSUNG does not warrant uninterrupted or error-free operation of the product.

# warranty (U.S.A)

---

EXCEPT AS SET FORTH HEREIN, THERE ARE NO WARRANTIES ON THIS PRODUCT EITHER EXPRESS OR IMPLIED, AND SAMSUNG DISCLAIMS ALL WARRANTIES INCLUDING, BUT NOT LIMITED TO, ANY IMPLIED WARRANTIES OF MERCHANTABILITY, INFRINGEMENT OR FITNESS FOR A PARTICULAR PURPOSE.

NO WARRANTY OR GUARANTEE GIVEN BY ANY PERSON, FIRM, OR CORPORATION WITH RESPECT TO THIS PRODUCT SHALL BE BINDING ON SAMSUNG.

SAMSUNG SHALL NOT BE LIABLE FOR LOSS OF REVENUE OR PROFITS, FAILURE TO REALIZE SAVINGS OR OTHER BENEFITS, OR ANY OTHER SPECIAL, INCIDENTAL OR CONSEQUENTIAL DAMAGES CAUSED BY THE USE, MISUSE, OR INABILITY TO USE THIS PRODUCT, REGARDLESS OF THE LEGAL THEORY ON WHICH THE CLAIM IS BASED, AND EVEN IF SAMSUNG HAS BEEN ADVISED OF THE POSSIBILITY OF SUCH DAMAGES.

NOR SHALL RECOVERY OF ANY KIND AGAINST SAMSUNG BE GREATER IN AMOUNT THAN THE PURCHASE PRICE OF THE PRODUCT SOLD BY SAMSUNG AND CAUSING THE ALLEGED DAMAGE.

WITHOUT LIMITING THE FOREGOING, PURCHASER ASSUMES ALL RISK AND LIABILITY FOR LOSS, DAMAGE, OR INJURY TO PURCHASER AND PURCHASER'S PROPERTY AND TO OTHERS AND THEIR PROPERTY ARISING OUT OF THE USE, MISUSE, OR INABILITY TO USE THIS PRODUCT. THIS LIMITED WARRANTY SHALL NOT EXTEND TO ANYONE OTHER THAN THE ORIGINAL PURCHASER OF THIS PRODUCT, IS NONTRANSFERABLE AND STATES YOUR EXCLUSIVE REMEDY.

Some states do not allow limitations on how long an implied warranty lasts, or the exclusion or limitation of incidental or consequential damages, so the above limitations or exclusions may not apply to you. This warranty gives you specific rights, and you may also have other rights, which vary from state to state.

**To obtain warranty service, please contact SAMSUNG at:**

**Samsung Electronics America, Inc.**

**85 Challenger Road Ridgefield Park, NJ 07660**

**1-800-SAMSUNG (726-7864)**

**[www.samsung.com/us/support](http://www.samsung.com/us/support)**

Visits by a Service Engineer to explain functions, maintenance or installation is not covered by warranty.

Please contact your Samsung call agent for help with any of these issues.

# warranty(CANADA)

---

## **SAMSUNG DRYER**

### **LIMITED WARRANTY TO ORIGINAL PURCHASER**

This SAMSUNG brand product, as supplied and distributed by SAMSUNG ELECTRONICS CANADA, INC. (SAMSUNG) and delivered new, in the original carton to the original consumer purchaser, is warranted by SAMSUNG against manufacturing defects in materials and workmanship for a limited warranty period of:

One (1) year part and labor

This limited warranty begins on the original date of purchase, and is valid only on products purchased and used in the Canada.

To receive warranty service, the purchaser must contact SAMSUNG for problem determination and service procedures.

Warranty service can only be performed by a SAMSUNG authorized service center.

The original dated bill of sale must be presented upon request as proof of purchase to SAMSUNG or SAMSUNG's authorized service center.

SAMSUNG will provide in-home service during the warranty period at no charge, subject to availability within the Canada.

In-home service is not available in all areas.

To receive in-home service, product must be unobstructed and accessible to the service agent.

If service is not available, SAMSUNG may elect to provide transportation of the product to and from an authorized service center.

SAMSUNG will repair, replace, or refund this product at our option and at no charge as stipulated herein, with new or reconditioned parts or products if found to be defective during the limited warranty period specified above.

All replaced parts and products become the property of SAMSUNG and must be returned to SAMSUNG.

Replacement parts and products assume the remaining original warranty, or ninety (90) days, whichever is longer.

This limited warranty covers manufacturing defects in materials and workmanship encountered in normal, noncommercial use of this product and shall not apply to the following: damage that occurs in shipment; delivery and installation; applications and uses for which this product was not intended; altered product or serial numbers; cosmetic damage or exterior finish; accidents, abuse, neglect, fire, water, lightning, or other acts of nature or God; use of products, equipment, systems, utilities, services, parts, supplies, accessories, applications, installations, repairs, external wiring or connectors not supplied or authorized by SAMSUNG that damage this product or result in service problems; incorrect electrical line voltage, fluctuations and surges; customer adjustments and failure to follow operating instructions, maintenance and environmental instructions that are covered and prescribed in the instruction book; product removal and reinstallation; problems caused by pest infestations.

This limited warranty does not cover problems resulting from incorrect electric current, voltage or supply, light bulbs, house fuses, house wiring, cost of a service call for instructions, or fixing installation errors.

SAMSUNG does not warrant uninterrupted or error-free operation of the product.

# warranty(CANADA)

---

EXCEPT AS SET FORTH HEREIN, THERE ARE NO WARRANTIES ON THIS PRODUCT EITHER EXPRESS OR IMPLIED, AND SAMSUNG DISCLAIMS ALL WARRANTIES INCLUDING, BUT NOT LIMITED TO, ANY IMPLIED WARRANTIES OF MERCHANTABILITY, INFRINGEMENT OR FITNESS FOR A PARTICULAR PURPOSE.

NO WARRANTY OR GUARANTEE GIVEN BY ANY PERSON, FIRM, OR CORPORATION WITH RESPECT TO THIS PRODUCT SHALL BE BINDING ON SAMSUNG.

SAMSUNG SHALL NOT BE LIABLE FOR LOSS OF REVENUE OR PROFITS, FAILURE TO REALIZE SAVINGS OR OTHER BENEFITS, OR ANY OTHER SPECIAL, INCIDENTAL OR CONSEQUENTIAL DAMAGES CAUSED BY THE USE, MISUSE, OR INABILITY TO USE THIS PRODUCT, REGARDLESS OF THE LEGAL THEORY ON WHICH THE CLAIM IS BASED, AND EVEN IF SAMSUNG HAS BEEN ADVISED OF THE POSSIBILITY OF SUCH DAMAGES.

NOR SHALL RECOVERY OF ANY KIND AGAINST SAMSUNG BE GREATER IN AMOUNT THAN THE PURCHASE PRICE OF THE PRODUCT SOLD BY SAMSUNG AND CAUSING THE ALLEGED DAMAGE.

WITHOUT LIMITING THE FOREGOING, PURCHASER ASSUMES ALL RISK AND LIABILITY FOR LOSS, DAMAGE, OR INJURY TO PURCHASER AND PURCHASER'S PROPERTY AND TO OTHERS AND THEIR PROPERTY ARISING OUT OF THE USE, MISUSE, OR INABILITY TO USE THIS PRODUCT. THIS LIMITED WARRANTY SHALL NOT EXTEND TO ANYONE OTHER THAN THE ORIGINAL PURCHASER OF THIS PRODUCT, IS NONTRANSFERABLE AND STATES YOUR EXCLUSIVE REMEDY.

Some provinces do not allow limitations on how long an implied warranty lasts, or the exclusion or limitation of incidental or consequential damages, so the above limitations or exclusions may not apply to you. This warranty gives you specific rights, and you may also have other rights, which vary from province to province.

**To obtain warranty service, please contact SAMSUNG at:**

**Samsung Electronics Canada Inc. 2050 Derry Road West, Mississauga, Ontario L5N 0B9 Canada.**

**1-800-SAMSUNG (726-7864)**

**[www.samsung.com/ca/support](http://www.samsung.com/ca/support) (English)**

**[www.samsung.com/ca\\_fr/support](http://www.samsung.com/ca_fr/support) (French)**

**FAX : 1-866-436-4617**

Visits by a Service Engineer to explain functions, maintenance or installation is not covered by warranty.

Please contact your Samsung call agent for help with any of these issues.

memo

---

memo

---

memo

---

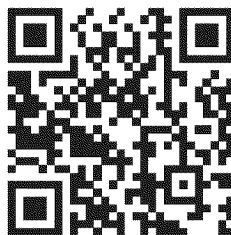

Scan the QR code\* or visit [www.samsung.com/spsn](http://www.samsung.com/spsn) to view our helpful How-to Videos and Live Shows

\*Requires reader to be installed on your smartphone

Scan this with your smartphone

### QUESTIONS OR COMMENTS?

Country	CALL	OR VISIT US ONLINE AT
U.S.A	1-800-SAMSUNG (726-7864)	<a href="http://www.samsung.com/us/support">www.samsung.com/us/support</a>
CANADA	1-800-SAMSUNG (726-7864)	<a href="http://www.samsung.com/ca/support">www.samsung.com/ca/support</a> (English) <a href="http://www.samsung.com/ca_fr/support">www.samsung.com/ca_fr/support</a> (French)
MEXICO	01-800-SAMSUNG (726-7864)	<a href="http://www.samsung.com/mx/support">www.samsung.com/mx/support</a>

Code No. DC68-03170K-01\_EN

Visits by a Service Engineer to explain functions, maintenance or installation is not covered by warranty.  
Please contact your Samsung call agent for help with any of these issues.