

Operator's Manual

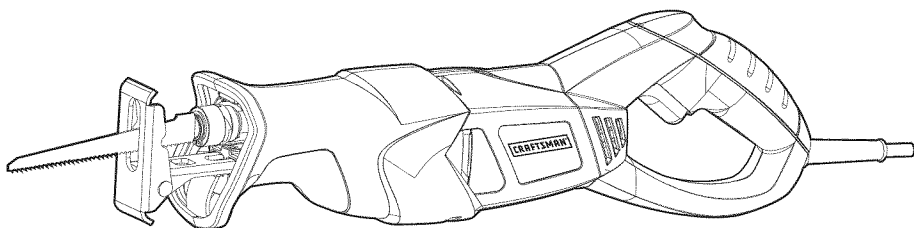

Compact Reciprocating Saw

Model No. 320. 17175



▲ CAUTION! Read, understand and follow all Safety Rules and Operating Instructions in this Manual before using this product.

- Warranty
- Safety
- Operation
- Assembly
- Maintenance

Sears, Roebuck and Co., Hoffman Estates, IL 60179

www.craftsman.com

TABLE OF CONTENTS

Warranty	Page 2
Safety Symbols	Page 3
Safety Instructions	Pages 4-9
Unpacking	Pages 9-10
Description	Pages 10-11
Operation	Pages 12-14
Maintenance	Page 15
Troubleshooting	Page 15
Part list	Pages 16-17
Sears Repair Parts Phone Numbers	Pages 18

ONE YEAR FULL WARRANTY ON CRAFTSMAN® TOOL

If this Craftsman tool fails to give complete satisfaction within one year from the date of purchase, return it to any Sears store or other Craftsman Outlet in the United States for free replacement.

This warranty does not include expendable parts, such as blades and lamps.

This warranty applies for only 90 days from the date of purchase if this product is ever used for commercial or rental purposes.

This warranty gives you specific legal rights, and you may also have other rights, which vary from state to state.

Sears, Roebuck and Co., Hoffman Estates IL 60179

▲ WARNING: Some dust created by using power tools contains chemicals known to the state of California to cause cancer and birth defects or other reproductive harm.

SAVE THESE INSTRUCTIONS!

READ ALL INSTRUCTIONS!

SAFETY SYMBOLS

The purpose of safety symbols is to attract your attention to possible dangers. The safety symbols and the explanations with them deserve your careful attention and understanding. The symbol warnings do not, by themselves, eliminate any danger. The instructions and warnings they give are no substitutes for proper accident prevention measures.

⚠ WARNING: Be sure to read and understand all safety instructions in this manual, including all safety alert symbols, such as “**DANGER,**” “**WARNING,**” and “**CAUTION,**” before using this Reciprocating Saw. Failure to following all instructions listed below may result in electric shock, fire and/or serious personal injury.

SYMBOL MEANNING

⚠ SAFETY ALERT SYMBOL: Indicates **DANGER, WARNING, OR CAUTION.** May be used in conjunction with other symbols or pictographs.

⚠ DANGER: Failure to obey this safety warning will result in death or serious injury to yourself or to others. Always follow the safety precautions to reduce the risk of fire, electric shock, and personal injury.

⚠ WARNING: Failure to obey this safety warning can result in death or serious injury to yourself or to others. Always follow the safety precautions to reduce the risk of fire, electric shock, and personal injury.

⚠ CAUTION: Failure to obey this safety warning may result in death or serious injury to yourself or to others. Always follow the safety precautions to reduce the risk of fire, electric, shock and personal injury.

DAMAGE PREVENTION AND INFORMATION MESSAGES

These inform user of important information and/or instructions that could lead to equipment or other property damage if not followed. Each message is preceded by the word “**NOTE**” as in the example below.

NOTE: Equipment and/or property damage may result if these instructions are not followed.

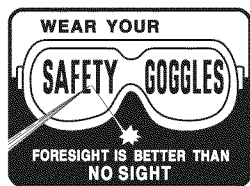

The operation of any power tool can result in foreign objects being thrown into your eyes, which can result in severe eye damage. Before beginning power tool operation, always wear safety goggles or safety glasses with side shields and a full-face shield when needed. We recommend a Wide Vision Safety Mask for use over eyeglasses or standard safety glasses with side shields, available at Sears Stores or other Craftsman outlets. Always use eye protection that is marked to comply with ANSI Z87.1

SAFETY INSTRUCTIONS

⚠ WARNING: Be sure to read and understand all instructions in this manual before using the reciprocating saw. Failure to follow all instructions may result in hazardous radiation exposure, electric shock, fire, and/or serious personal injury.

⚠ WARNING: Do not attempt to operate this tool until you have thoroughly read all instructions, safety rules, and warnings. Failure to comply with them can result in fire, electric shock, or serious personal injury. Save the manual and refer to it frequently.

GENERAL SAFETY PRECAUTIONS

WORK AREA SAFETY

- **Keep your work area clean and well lit.** Do not leave tools or wood scraps on the saw while it is in operation. Cluttered workbenches and dark areas invite accidents
- **Do not operate power tools in explosive environments,** such as in the presence of flammable liquids, gases, or dust. Power tools create sparks that may ignite the dust or fumes.
- **Keep children and bystanders and visitors away** while operating a power tool. Distractions can cause you to lose control.
- **Make your workshop childproof** with padlocks and master switches. Lock tools away when they are not in use.
- **Make sure that the work area has ample lighting** so you can see the work and that there are no obstructions that will interfere with safe operation.

PERSONAL SAFETY

- **Know your power tool.** Read this operator's manual carefully. Learn the reciprocating saw's applications and limitations, as well as the specific, potential hazards related to this tool.
- **Stay alert,** watch what you are doing, and use common sense when operating a power tool.
- **Do not** use a power tool while tired or under the influence of drugs, alcohol, or medication. A moment of inattention while operating power tools may result in serious personal injury.
- **Dress properly.** Do not wear loose clothing or jewelry. Contain long hair. Keep your hair, clothing, and gloves away from moving parts. Loose clothes, jewelry, or long hair can be caught in moving parts.
- **Avoid accidental starting of tools.** Be sure that the switch is off before attaching the tool to a power source. Carrying tools with your finger on the switch or plugging in tools that have the switch "ON" invites accidents.

- **Remove adjusting keys or wrenches before turning the tool on.** A wrench or a key that is left attached to a rotating part of the tool may result in personal injury.
- **Do not overreach. Keep proper footing and balance at all times.** Proper footing and balance enables better control of the tool in unexpected situations.
- **Use safety equipment.** Always wear eye protection. A dust mask, non-skid safety shoes, hard hat, and/or hearing protection must be used for appropriate conditions.

TOOL USE AND CARE

 **WARNING:** Be sure to read, understand, and follow all safety rules and operating instructions in this manual before using this tool. Failure to do so may result in electric shock, fire, and/or serious personal injury.

- **Always** use clamps or other practical ways to support and secure the workpiece to a stable platform. Holding the work by hand or against your body is unstable and may lead to loss of control.
- **Do not force the tool.** Use the correct tool for your application. The correct tool will do the job better and more safely at the rate for which is designed.
- **Do not** use the tool if the switch does not turn it “ON” and “OFF.” Any tool that cannot be controlled with the switch is dangerous and must be repaired.
- **Disconnect** the plug from the power source before making any adjustments, changing accessories, or storing the tool. Such preventive safety measures reduce the risk of starting the tool accidentally.
- **Never** leave the tool running. Always turn it off. Do not leave the tool until it comes to a complete stop.
- **Store idle tools out of the reach of children and other untrained persons.** Tools are dangerous in the hands of untrained users.
- **Maintain tools with care. Keep cutting tools sharp and clean.** Properly maintained tools with sharp cutting edges are less likely to bind and are easier to control.
- **Check** for misalignment or binding of moving parts, breakage of parts, and any other condition that may affect the tool’s operation. If damaged, have the tool serviced before using. Many accidents are caused by poorly maintained tools.
- **Use only** accessories that are recommended by the manufacturer for your model. Accessories that may be suitable for one tool may become hazardous when used on another tool.

 **WARNING:** When using power tools, basic safety precautions should always be followed to reduce the risk of fire, electric shock, and personal injury.

⚠ WARNING: The operation of any tool can result in foreign objects being propelled into your eyes, resulting in severe eye damage. When operating power tool, always wear safety goggles or safety glasses with side shields and a full face shield when needed.

⚠ WARNING: If any part is missing, do not operate the tool until the missing part has been replaced. Doing so could result in serious personal injury.

ELECTRICAL SAFETY

- **Double insulated tools are equipped** with a polarized plug (one blade is wider than the other). This plug will fit into a polarized outlet only one way. If the plug does not fit into the outlet, reverse the plug. If it still does not fit, contact a qualified electrician to install a proper outlet.
- **Avoid contact with grounded surfaces, such as pipes, radiators, ranges, and refrigerators.** There is an increased risk of electric shock if your body is grounded.
- **Do not expose power tools to rain or wet conditions.** A wet power tool will increase the risk of electric shock.
- **Do not abuse the cord.** Never use the cord to carry the tool or to pull the plug out of an outlet. Keep the cord away from heat, oil, sharp edges, or moving parts. Replace damaged cords immediately. Damaged cords increase the risk of electric shock.
- **When operating a power tool outdoors, use an outdoor extension cord that is marked W-A or W.** These cords are rated for outdoor use and reduce the risk of electric shock.
- Replace damaged cords immediately. Using a damaged cord can cause shock, burns, or electrocution.
- If an extension cord is required, use a cord with the proper size of conductor to prevent excessive voltage drop, loss of power, or overheating. The following table shows the correct size to use, depending on cord length and the nameplate amperage rating of the tool. When in doubt, use the next heavier gauge. Always use UL and CSA listed extension cords.

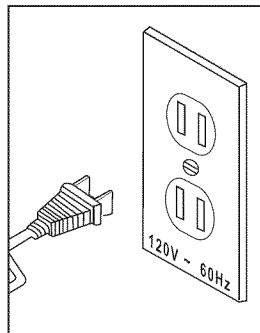



Recommended sizes of extension cords

Ampere Rating		Volts	Total Length of Cord in feet			
		120v	25ft	50ft	100ft	150ft
More Than	Not More Than	AWG				
0	6		18	16	16	14
6	10		18	16	14	12
10	12		16	16	14	12
12	16		14	12	Not Recommended	

- **Before connecting the tool** to a power source (receptacle, outlet, etc.), be sure that the voltage supplied is the same as that specified on the nameplate of the tool. A power source with voltage greater than that specified for the tool can result in serious injury to the user, as well as damage to the tool.

SAFETY SYMBOLS FOR YOUR TOOL

The label on your tool may include the following symbols.

V.....	Volts
A.....	Amps
Hz.....	Hertz
W.....	Watts
min.....	Minutes
	Alternating Current
—.....	Direct Current
no.....	No-load Speed
	Class II construction
.../min.....	Revolutions or Strokes per minute
	Indicates danger, warning caution. It means attention! Your safety is involved.

SERVICE SAFETY

- **If any part of this saw is missing or should break, bend, or fail in any way;** or should any electrical component fail to perform properly: shut off the power switch, remove the saw's plug from the power source, and have the missing, damaged, or failed part replaced before resuming operation.
- **Tool service must be performed only at a Sears Parts and Repair Center.** Service or maintenance performed by unqualified personnel could result in a risk of injury.

- **When servicing a tool, use only identical replacement parts. Follow instructions in the maintenance section of this manual.** Use of unauthorized parts or failure to follow maintenance instructions may create a risk of electric shock or injury.

SPECIFIC SAFETY RULES FOR RECIPROCATING SAW

⚠ WARNING: To avoid injury, hold the tool by the insulated gripping surfaces only. If the tool contacts hidden wiring or its own cord, exposed metal parts of the tool could shock the operator and cause serious injury. Make sure that hidden electrical wiring, water pipes, or other hazards are not in the cutting path.

- **If you are not thoroughly familiar with the operation** of a reciprocating saw, obtain advice from a qualified person.
- **When servicing**, use only identical replacement parts.
- **Avoid cutting nails and staples when operating with the wood blade.** Inspect the workpiece carefully and remove all nails and staples before operation.
- **Make sure** that the blade always extends beyond the shoe and the workpiece throughout the stroke. Blades may shatter if they strike the workpiece or shoe.
- **Do not cut an oversized workpiece.**
- **Check for proper clearance** beyond the workpiece before cutting, so that the blade will not strike the floor, workbench, etc.
- **Make sure that the blade** is not contacting the workpiece before the switch is turned on.
- **Keep the saw blades clean and sharp.**
- **Use only correct blades.** Always use blades recommended for the type of workpiece.
- **Do not leave the tool running.** Operate the tool only when hand-held.
- **Always release the switch to “OFF” and wait for the tool to come to a complete stop before removing the blade from the workpiece.**
- **Keep the handle dry, clean, and free from oil and grease.** Always use a clean cloth when cleaning. Do not use solvents, brake fluids, gasoline or other petroleum products to clean the tool; they may damage plastic parts.
- **Do not operate this tool in a gaseous or explosive environment or near explosive materials.**
- **Never force the tool.** Apply firm pressure against the saw’s pivot shoe for the sawing operation--too little or too much pressure could cause jumping or vibration and may break the blade.

- **Never** operate the saw without the pivot shoe in position. The spindle may strike against the workpiece and damage the reciprocating mechanism.
- **Do not touch the blade** or the workpiece immediately after the sawing operation. They may be extremely hot and could burn your skin.
- **Hold the tool firmly** with two hands when operating the tool.
- **Do not reach underneath** the workpiece. The proximity of the blade to your hand is hidden from your sight.
- **Hold tool by the insulated gripping surfaces when performing an operation where the cutting tool may contact hidden wiring or its own cord.**

UNPACKING

 **WARNING:** Your saw should never be connected to the power source when you are assembling parts, making adjustments, installing or removing blades, cleaning, or when it is not in use. Disconnecting the reciprocating saw will prevent accidental starting, which could cause serious personal injury.

When unpacking the box, do not discard any packing materials until all of the contents are accounted for:

1. Carefully lift the reciprocating saw out of the carton and place on a stable, flat surface.
2. Open the parts bag to locate the following:
 - 1 Wood-Cutting Blade
 - 1 Hex Key
3. Inspect the items carefully to make sure that no breakage or damage has occurred during shipping. If any of the items mentioned is missing, (refer to “PARTS LIST” illustration), return the reciprocating saw to your nearest Sears store or Craftsman outlet to have the missing parts replaced.

 **WARNING:** If any part is broken or missing, do not attempt to assemble the reciprocating saw, plug in the power cord, or operate the saw until the broken or missing parts are replaced. Failure to do so could result in possible serious injury.

CARTON CONTENTS/LOOSE PARTS (Fig. 1)

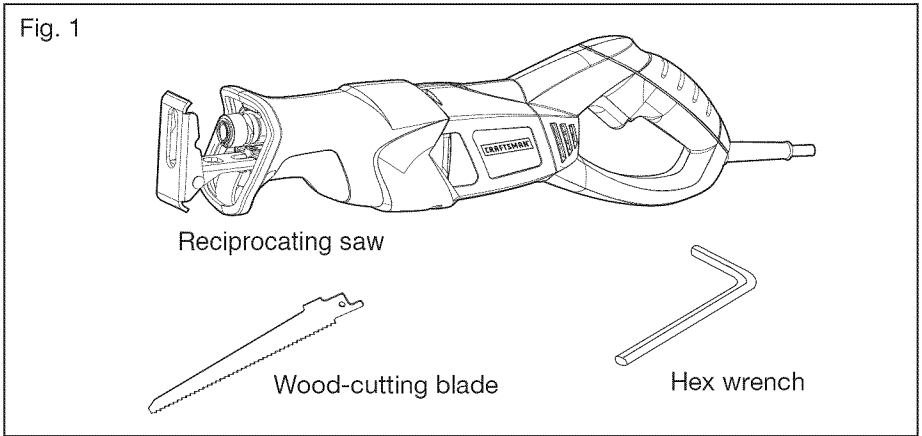

DESCRIPTION

KNOW YOUR RECIPROCATING SAW (Fig. 2)

Before attempting to use this reciprocating saw, familiarize yourself with all of its operating features and safety requirements.

⚠ WARNING: Do not allow familiarity with your reciprocating saw to make you careless. Remember that a careless fraction of a second is sufficient to inflict severe injury.

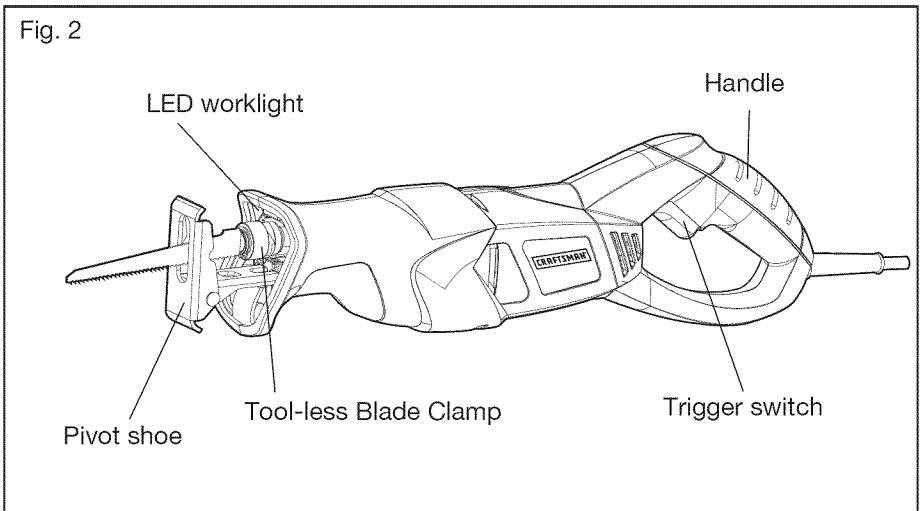

PRODUCT SPECIFICATIONS	
Motor	120V~ 60Hz, 6A
Variable Speed:	0-2700/Min
Blade stroke	25/32"
Weight	6.39 lbs (2.9 kg)

⚠ WARNING: The safe use of this product requires an understanding of the information on the tool and in this operator's manual, as well as knowledge of the project you are attempting. Before use of this product, familiarize yourself with all operating features and safety rules.

TOOL-LESS BLADE CLAMP

The saw has a blade clamp design that does not require the use of a tool (blade wrench) when installing or removing the blade. See **INSTALLING SAW BLADE** on **PAGE 12**.

VARIABLE-SPEED TRIGGER SWITCH

The variable-speed trigger switch delivers higher speed with increased trigger pressure and lower speed with decreased trigger pressure.

LED WORKLIGHT

The LED worklight, located on the front of the saw, illuminates when saw is plugged in. This feature provides extra light for increased visibility.

PIVOT SHOE

The pivoting shoe adjusts in and out to allow control of the amount of blade that is exposed.

⚠ WARNING: To avoid injury and damage, do not operate the saw without the pivot shoe in place. The spindle may strike against the workpiece and damage the reciprocating mechanism.

OPERATION

ON/OFF SWITCH AND VARIABLE SPEED CONTROL (Fig. 3)

Your reciprocating saw is equipped with a trigger switch to turn the saw on and off and to control the speed.

1. To start the saw, squeeze the trigger switch.
2. To stop the saw, release the trigger switch and allow it to return to the "OFF" position.
3. To vary the speed, simply increase or decrease the pressure on the trigger switch. The more tightly the trigger switch is squeezed, the higher the speed.

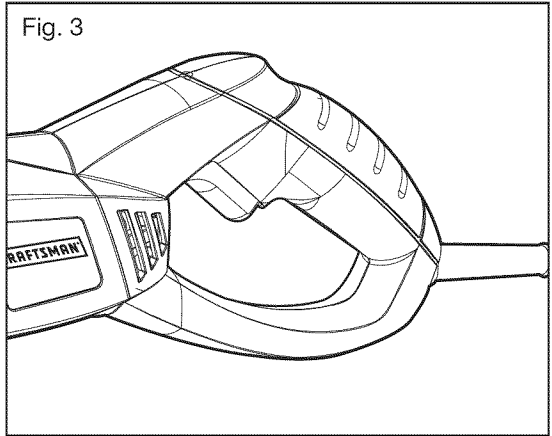

LED WORKLIGHT (Fig. 4)

This LED Worklight is located on the front of the saw and provides additional lighting on the surface of the workpiece for operation in lower-light areas. The worklight will turn on when plugged in. The worklight will turn off when the saw is unplugged.

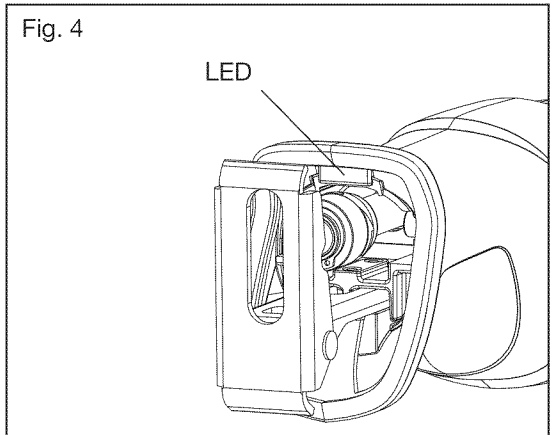

INSTALLING SAW BLADE (Fig. 5)

1. Unplug the saw.
2. While rotating the sleeve of the clamp counter-clockwise, insert the saw blade into the blade clamp as far as possible, then release the sleeve; the blade will lock in place automatically.

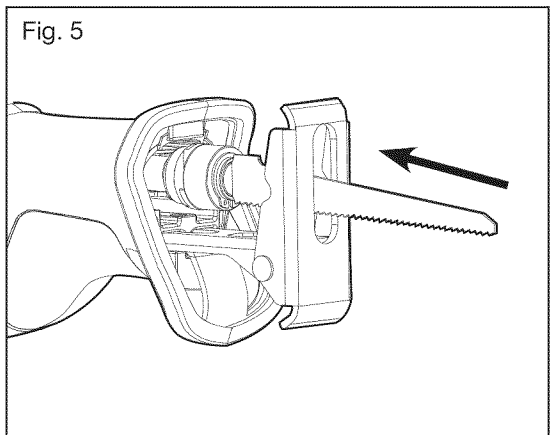

NOTE: The blade may be installed with the teeth pointing up or down, according to the needs of the cutting operation.

REMOVING SAW BLADE (Fig. 5)

1. Unplug the saw.
2. Rotate the sleeve counter-clockwise, and then pull the blade out.

⚠ WARNING: Do not remove the blade immediately after the cutting; the blade may be very hot!

BLADE SELECTION

To obtain the best performance from the saw, it is important to select the correct blade for the particular application and type of material you wish to cut. This will produce a smoother, faster cut and prolong blade life.

BASE (SHOE) ASSEMBLY

To Slide Shoe In or Out: (See Fig.6)

The base assembly slides in or out to adjust the effective stroke length for maximum control and longer blade life.

1. Unplug the saw.
2. Loosen the two Hexagon Socket Screws with the hex key.
3. Pull the shoe base to desired position.
4. Tighten the Hexagon socket screws

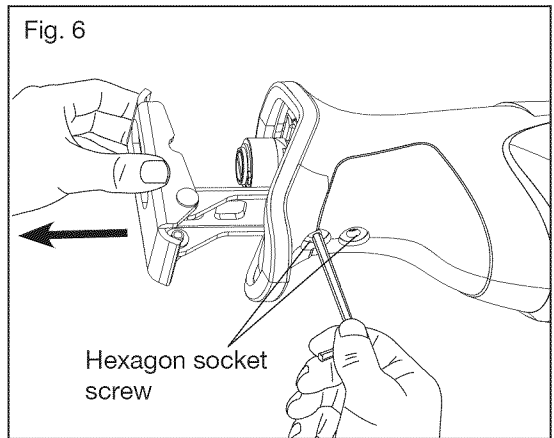

To Pivot Shoe: (See Fig.6)

The shoe pivots to provide maximum control against the surface being cut.

1. Unplug the saw.
2. Firmly hold the saw and then pivot the shoe to the desired position.

GENERAL CUTTING

⚠ WARNING: Before plugging in the tool, always check to determine that the switch performs properly and returns to the “OFF” position when released.

⚠ WARNING: Hold the tool only by the plastic handle and the insulated grip area to help prevent electrical shock. When sawing into walls or floors you may encounter electrical wiring. Sawing into a “live” wire will cause electric shock.

1. Unplug the saw.
2. Make sure that the workpiece is firmly anchored: clamp the workpiece to prevent slipping or moving while cutting.
3. Use the appropriate type and size of blade for the workpiece material and size.
4. Adjust the pivot shoe as necessary to make sure that the blade will extend beyond the shoe and the workpiece at all times.
5. Adjust the pivot shoe as necessary to expose unworn blade teeth for longer blade life.
6. Check for clearance behind the workpiece so that the blade will not impact another surface.
7. Mark the line of cut clearly. If cutting metal, apply cutting oil on the line.
8. Plug the reciprocating saw into an electrical outlet
9. Hold the saw firmly with both hands. Make sure to keep your hands on the insulated gripping areas only.
10. Depress the trigger switch to start the saw and bring it to the maximum desired cutting speed before applying the blade to the workpiece.
11. Do not force the tool. Place the shoe firmly on the workpiece while cutting. Use only enough steady pressure on the blade to keep the saw cutting.
12. Reduce pressure as the blade comes to the end of the cut.
13. Allow the saw to come to a complete stop before removing the blade from the workpiece.
14. If sawing fiberglass, plaster, wallboard, or spackling compound, clean the saw motor vents frequently with a vacuum or compressed air. These materials are very abrasive and may accelerate the wear on motor bearings and brushes.

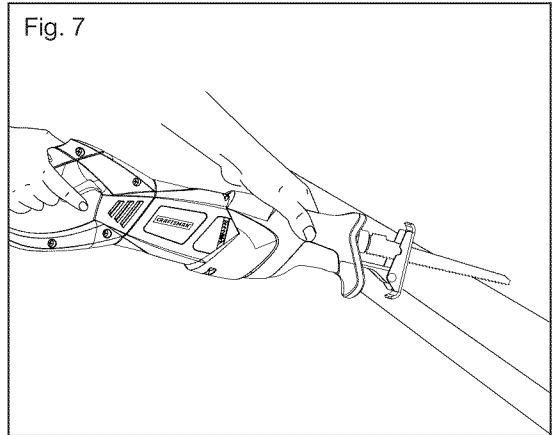

NOTE: Cutting speeds should vary with the workpiece. Hard materials, such as metals, require lower speeds; for softer materials use higher speeds.

⚠ WARNING: Do not allow familiarity with the saw to make you careless. One careless fraction of a second is enough to inflict serious injury.

PLUNGE CUTTING

Your Craftsman compact reciprocating saw is ideal for plunge cutting directly into surfaces that cannot be cut from an edge, such as walls or floors. Plunge cutting may be done two ways depending on how the blade is inserted. Column A shows how to plunge cut with the teeth of the blade facing down. Column B shows how to plunge cut with the teeth of the blade facing up.

⚠ WARNING: Do not plunge cut into metal surfaces.

1. Insert the blade into the tool. If you inserted the blade with the teeth facing downward, hold the tool as shown in Column A, resting the edge of the shoe on the workpiece. If you inserted the blade with the teeth facing upward, hold the tool as shown in Column B, resting the edge of the shoe on the workpiece as shown.
2. With the blade just above the workpiece, pull the trigger. Using the edge of the shoe as a pivot, lower the blade into the workpiece as shown.
3. As the blade starts cutting, raise the handle of the tool slowly until the shoe rest firmly on the workpiece. Then guide the tool along your cutting line to acquire the desired cut.

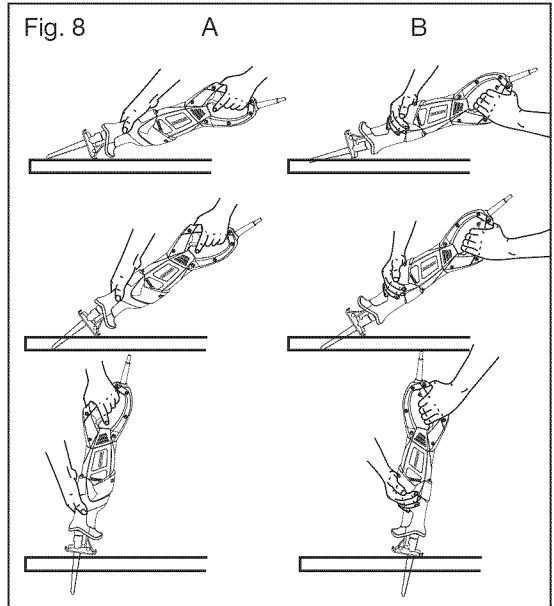

Note: To make plunge cutting easier, use a heavy gauge blade and install the blade with the teeth facing upward as show in colum B.

⚠ WARNING: To reduce the risk of explosion , electric shock and property damage, always check the work area for hidden gas pipes, electrical wires or water pipes when making blind or plunge cut.

4. Switch on the tool, allow it to come to the desired speed, and carefully pivot the tool so that the moving saw blade pierces the workpiece.
5. After the blade has penetrated through the workpiece, continue sawing along the marked cutting line.

⚠ WARNING: To avoid loss of control and serious injury, make sure that the blade reaches maximum speed before touching it to the workpiece.

⚠ WARNING: Do not make plunge cuts in metal materials.

MAINTENANCE

⚠ WARNING: To ensure safety and reliability, all repairs should be performed by a qualified service technician at a Sears Service Center.

⚠ WARNING: For your safety, always turn off the switch and unplug the reciprocating saw from the power source before performing any maintenance or cleaning.

Periodic maintenance of your reciprocating saw allows for long life and trouble-free operation. The saw can generate considerable quantities of cutting residue. A cleaning, lubrication, and maintenance schedule should be maintained.

As a common-sense and preventive maintenance practice, follow these recommended steps:

- Inspect the blade; check the rim for wear or damage.
- Keep the ventilation slots of the motor clean to prevent overheating of the motor. Electric tools are subject to accelerated wear and possible premature failure when they are used to work on fiberglass boats and sports cars, wallboard, spackling compounds or plaster. The chips and grindings from these materials are highly abrasive to electrical tool parts, such as bearings, brushes, commutators, etc. Consequently, it is not recommended that this tool be used for extended work on any fiberglass material, wallboard, spackling compound, or plaster. During any use on these materials, it is extremely important that the tool is cleaned frequently by blowing with an air jet.
- Use a soft clean and damp cloth to wipe the tool housing. A mild detergent can be used but nothing like alcohol, petrol or other cleaning agent. Never use caustic agents to clean plastic parts.

⚠ WARNING: Always wear safety goggles or safety glasses with side shields during power tool operations or when blowing dust. If operation is dusty, also wear a dust mask.

⚠ WARNING: When changing a blade immediately after operation, allow the blade to cool before removing it to avoid possible burning.

⚠ WARNING: Keep the tool's air vents unclogged and clean at all times.

⚠ WARNING: Avoid using solvents when cleaning plastic parts. Most plastics are susceptible to damage from various types of commercial solvents and may be damaged by their use. Use clean cloths to remove dirt, dust, oil, grease, etc.

⚠ WARNING: Do not at any time let brake fluids, gasoline, petroleum-based products, penetrating oils, etc. to come in contact with plastic parts. Chemicals can damage, weaken or destroy plastic which may result in serious personal injury.

⚠ CAUTION: Water must never come into the tool.

TROUBLESHOOTING

PROBLEM	CAUSE	SOLUTION
The saw does not work	Not plugged into power source	Plug the saw into a power source
Blade cannot be removed	Saw dust in the slot	Clean the clamp slot with brush

PARTS LIST

No	Part No	Part Name	QTY
1	5610034000	Tapping Screw	1
2	5610106000	Tapping Screw	6
3	3320452000	Right Handle	1
4	5610024000	Tapping Screw	2
5	3120234000	Cord Anchorage	1
6	4870337000	Switch	1
7	5610006000	Tapping Screw	4
8	4960010000	Carbon Brush	2
9	2800153000	Brush Holder	2
10	3121045000	Cord Guard	1
11	3123256000	Motor Housing	1
12	3320451000	Left handle	1
13	4930061000	Shark Teeth Terminal	2
14	4930056000	Terminal	4
15	4860006000	Internal Wire ASSY	4
16	4930025000	Receptacle	2
17	4810002000	Power Cord & Plug	1
18	2740242000	Stator	1
19	5610049000	Tapping Screw	2
20	3123301000	Fan Baffle	1
21	3121026000	Bearing Holder	1
22	5650038000	Plain Washer	1
23	5700004000	Ball Bearing	1
24	2750842000	Rotor	1
25	3703853000	Bearing Retainer	1
26	5650199000	Plain Washer	1
27	5700010000	Ball Bearing	1
28	5650043000	Plain Washer	1
29	5660009000	Circlips For Shaft	1

No	Part No	Part Name	QTY
30	3121048000	Rubber Spring	1
31	2822287000	Pivot Shoe	1
32	3122839000	Screw Cover	2
33	5620018000	Hexagon Socket Screw	2
34	5650015000	Spring Washer	10
35	3703859000	Front Handle Support	1
36	2822573000	LED ASSY	1
37	3123255000	Front Handle	1
38	5610047000	Tapping Screw	4
39	3123308000	Cover	1
40	4890419000	PCB Assembly	1
41	5700008000	Ball Bearing	1
42	3420549000	Gear Case	1
43	5620039000	Screw	1
44	5650007000	Spring Washer	1
45	5650004000	Plain Washer	1
46	5700048000	Ball Bearing	1
47	4930004000	Connecter	1
48	3550860000	Gear	1
49	3550861000	Gear Shaft	1
50	3550279000	Pin	1
51	3550277000	Crank Roller	1
52	3420550000	gear case cover	1
53	5650014000	Plain Washer	4
54	5620051000	Screw	4
55	3520255000	Guiding Bearing	2
56	3703857000	Bearing Clamp	2
57	5620050000	Screw	4
58	2822253000	Plunger ASSY	1
59	5670169000	Pin	1

No	Part No	Part Name	QTY
60	5670039000	Pin	1
61	5670042000	Located Pin	1
62	3700546000	Felt Block	1
63	5660032000	Circlips For Shaft	1
64	3123316000	Cover	1
65	3660296000	Torsion Spring	1
66	3550863000	Bush	1
67	3550864000	Rotate Bush	1
68	5660145000	Circlips For Shaft	1

NOTE

NOTE

Get it fixed, at your home or ours!

Your Home

For expert troubleshooting and home solutions advice:

manage my home

www.managemyhome.com

For repair – **in your home** – of **all** major brand appliances, lawn and garden equipment, or heating and cooling systems, **no matter who made it, no matter who sold it!**

For the replacement parts, accessories and owner's manuals that you need to do-it-yourself.

For Sears professional installation of home appliances and items like garage door openers and water heaters.

1-800-4-MY-HOME[®]

(1-800-469-4663)

www.sears.com

Call anytime, day or night

(U.S.A. and Canada)

www.sears.ca

Our Home

For repair of carry-in items like vacuums, lawn equipment, and electronics, call anytime for the location of the nearest **Sears Parts & Repair Service Center**

1-800-488-1222 (U.S.A.)

www.sears.com

1-800-469-4663 (Canada)

www.sears.ca

To purchase a protection agreement on a product serviced by Sears:

1-800-827-6655 (U.S.A.)

1-800-361-6665 (Canada)

Para pedir servicio de reparación a domicilio, y para ordenar piezas:

1-888-SU-HOGAR[®]

(1-888-784-6427)

Au Canada pour service en français:

1-800-LE-FOYER^{MC}

(1-800-533-6937)

www.sears.ca

Sears

© Sears Brands, LLC

[®] Registered Trademark / [™] Trademark / SM Service Mark of Sears Brands, LLC

[®] Marca Registrada / [™] Marca de Fábrica / SM Marca de Servicio de Sears Brands, LLC

^{MC} Marque de commerce / ^{MD} Marque déposée de Sears Brands, LLC