



HS600D

User Manual | **V1.0**



+1 (833) 788-4733
www.holystone.com

usa@holystone.com (USA) ca@holystone.com (CA)
eu@holystone.com (EU) au@holystone.com (AU)

CONTENTS

1

Product Introduction

- 01 Package Contents
- 02 Diagram of the Drone
- 03 Diagram of the Transmitter

3

Product Functions

- 27 Flight Functions
- 34 APP Functions
- 49 Stabilization Function

2

Operation Guidance

- 09 Charging 17
- 11 Pre-Flight Preparations Flight
- 16 Pre-Flight Checklist

4

Appendix

- 52 Specifications 56
- 54 Contact Us Compliance Information
- 55 Trouble Shootings

Reading Guidance

Icon

“⚠️” essential precautions.

“💡” tips for operation and usage.

Recommended Steps

Our product offers both tutorial videos and the following resources:

- Disclaimer and Safety Guidelines
- Quick Start Guide
- User Manual

For a smooth start, we suggest watching the tutorial videos and reviewing the "Disclaimer and Safety Guidelines" first. Then, familiarize yourself with the basics through the "Quick Start Guide". For a comprehensive understanding, delve into the "User Manual".

Access Tutorial Videos

To ensure you're using the product safely and correctly, scan the QR code below to view our tutorial videos.



Download the HS FLY App

Simply scan the QR code below.



iOS



Android APP on Google play

Required Operating Systems: iOS 11.0 or later / Android 5.1 or later.

1.1 Package Contents >>

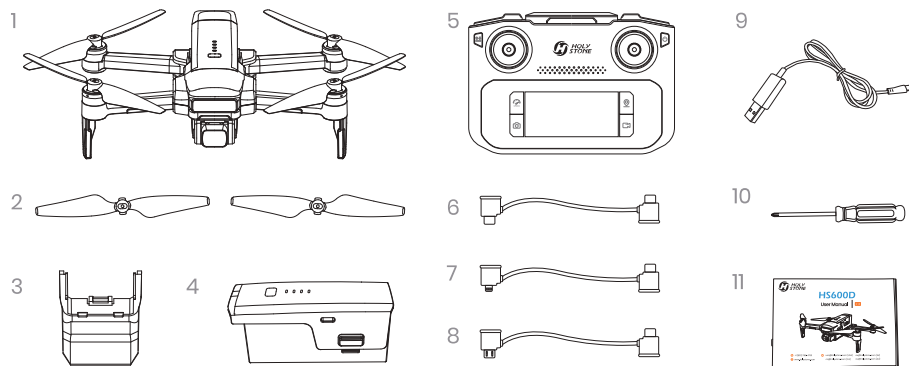

- 1 Drone
- 2 Propellers
- 3 Camera Cover
- 4 Drone Battery
- 5 Transmitter
- 6 Connection Cable (lightning)
- 7 Connection Cable (micro-USB)
- 8 USB Charging Cable (type-C)
- 9 USB Charging Cable (type-C)
- 10 Screwdriver
- 11 User Manual

1.2 Diagram of the Drone >>

Drone

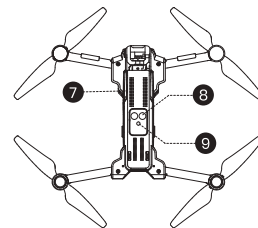
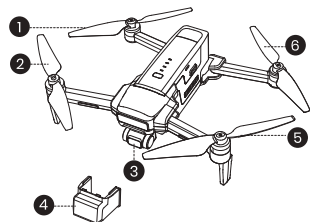

- 1 Propeller A
- 2 Propeller B
- 3 Gimbal and Camera
- 4 Camera Cover
- 5 Propeller A
- 6 Propeller B
- 7 TF Card Slot
- 8 Optical Flow Indicator
- 9 Optical Flow Lens

Battery of the Drone

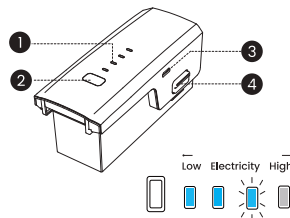

- 1 Battery Level Indicators
- 2 Power Switch
- 3 Charging Port (Type-C)
- 4 Battery Extraction Button

On/Off: Turn the battery on/off by **pressing the power switch for 3 seconds**. When the battery is on, the battery level indicators will display the current battery status. When the battery is powered off, all the indicators are out.

⚡ Equipped with a self-discharge protection, the battery, if left unused for more than 3 days post full-charge, will autonomously lower its charge to 70-75% to maintain its health.

1.3 Diagram of the Transmitter >>

Transmitter Functions

● Front:

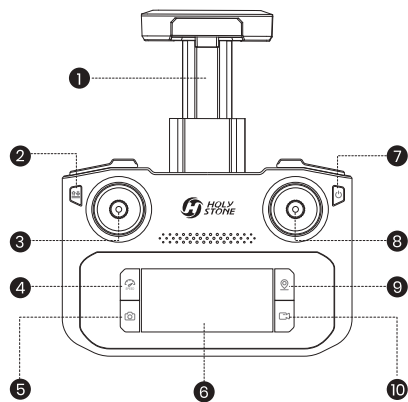

● Top:

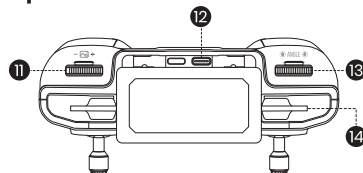

● Bottom:

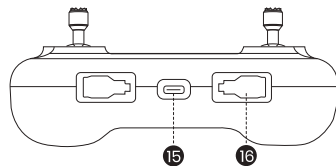

- | | | |
|-------------------------------------|--------------------------------------|--------------------------------|
| 1 Cellphone Holder | 2 Takeoff/Landing: Short Press | Emergency Stop: Long Press |
| 3 Left Joystick | 4 Speed Switch: Short Press | Cruise Control: Long Press |
| 5 Take Photo | 6 LCD Screen | |
| 7 Check Battery Level : Short Press | Power Switch: Short press, then hold | 8 Right Joystick |
| 9 Return to Home: Short Press | GPS Switch on/off: Long Press | 10 Record Video |
| 11 Zoom Dial | 12 Connection Port | 13 Gimbal Dial |
| 14 Cellphone Slot | 15 Charging Port (Type-C) | 16 Storage Slots for Joysticks |

- 💡 Check Battery Level: Short press the power switch (🔌) once to check the current battery level. If the battery level is too low, recharge before use.
- Turning on/off: Short press the power switch (🔌) once, then hold it for 3 seconds to turn on/off the transmitter.

1.3 Diagram of the Transmitter >>

LCD Screen

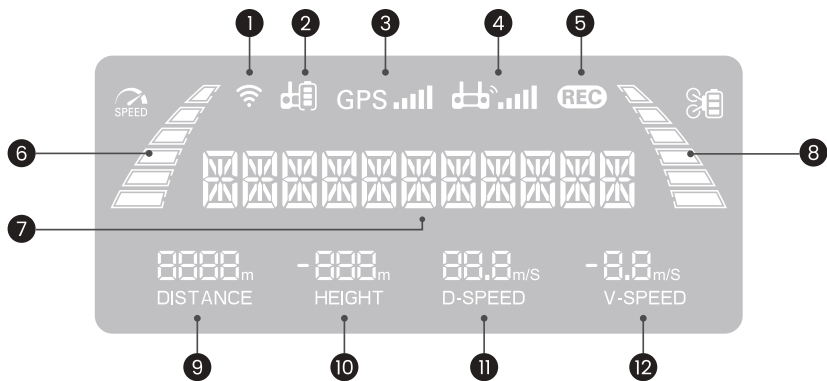

- | | | |
|-------------------------------|-----------------------------|-----------------------|
| 1 Transmitter WiFi Signal | 2 Transmitter Battery Level | 3 GPS Signal Strength |
| 4 Transmitter Signal Strength | 5 Camera Status | 6 Flight Speed |
| 7 Drone Status | 8 Drone Battery Level | 9 Flight Distance |
| 10 Flight Height | 11 Horizontal Speed | 12 Vertical Speed |

- ⚠ Unit Switching: Press and hold the button while simultaneously pressing the power button twice. The units "m" and "ft" on the LCD screen can be toggled between each other. The last toggled unit will be the default unit upon restarting.
- When the battery level of the transmitter is low, its icon () will start to flash. When this happens, please bring the drone down to the ground immediately and charge the transmitter.

1.3 Diagram of the Transmitter >>

Joystick Mode

- **Mode 2:** (Left joystick as the throttle joystick)

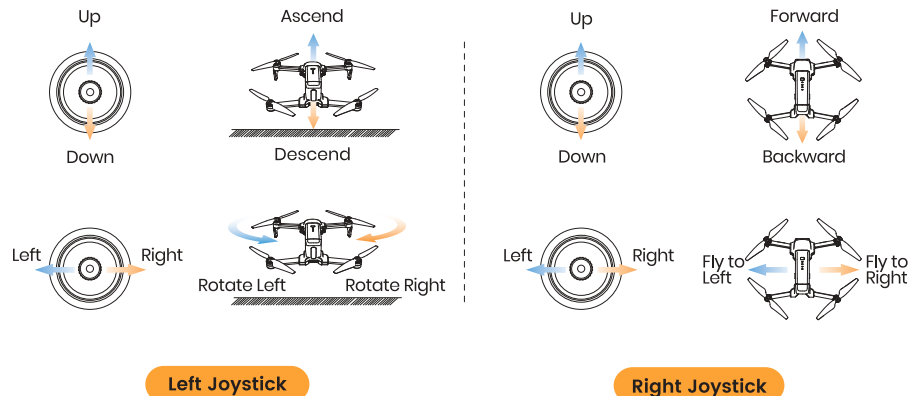

- **Mode 1:** (Right joystick as the throttle joystick)

Hold the button, short press the button of the transmitter once, then hold the latter until the transmitter quickly beeps 3 times. You will see "R HAND MODE" displayed on the LCD screen, which means the transmitter is now in Mode 1.

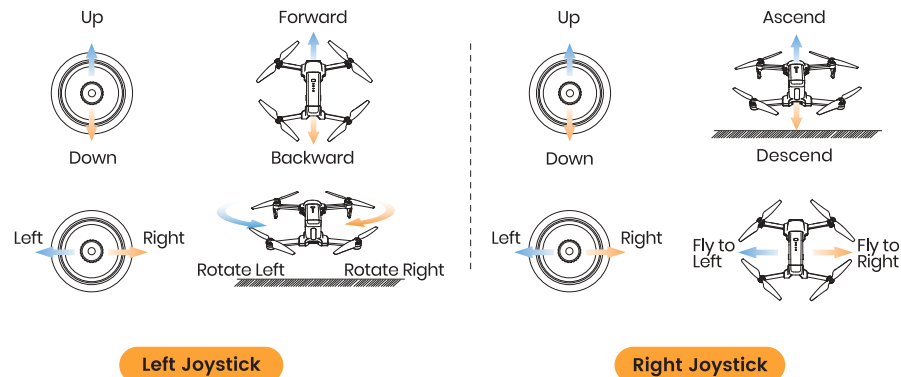

2.1 Charging >>

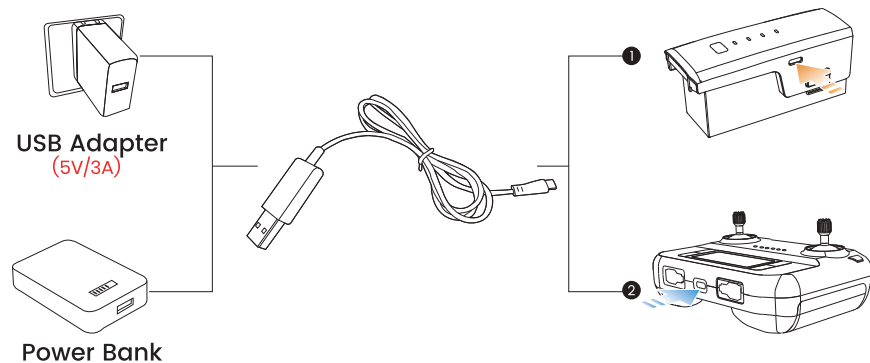

- ⚠** · Before charging, please read the instructions in the "Battery Safety" section of the "Disclaimer and Safety Guidelines" carefully!
- DO NOT charge the drone battery immediately after a flight as the temperature may be too high. Please wait until it cools down to room temperature before charging again.
 - Please use the original charging cable to charge the drone battery and transmitter.
 - The transmitter cannot be turned on while charging.

1 Charging of the Drone Battery:

- 1 Insert the Type-C plug of the charging cable into the drone battery.
- 2 Plug the other end of the cable into a USB adapter (5V/3A) or power bank to start charging.
- 3 When the battery is charging, the battery level indicators **will keep flashing**. When it is fully charged, all the indicators **will be on**.
- 4 It takes about 2 hours to fully charge a drone battery.

2 Charging of the Transmitter:

- 1 Insert the Type-C plug of the charging cable into the Type-C port of the transmitter.
- 2 Plug the other end of the cable into a USB adapter (5V/3A) or powerbank to start charging.
- 3 When charging, the cells in the battery level bar will light up in turn. The LCD screen displays "**CHARGING.**" When the charging is done, all 3 cells will light up and the LCD screen displays "**CHARGE DONE.**"
- 4 It takes about 2 hours to fully charge the transmitter. A fully charged transmitter offers about 2.5 hours of usage time.

2.2 Pre-Flight Preparations >>

Joysticks

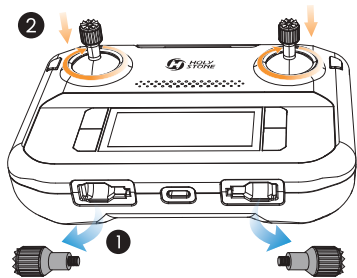

Take the joysticks out of the storage slot and mount them onto the transmitter.

Landing Gear

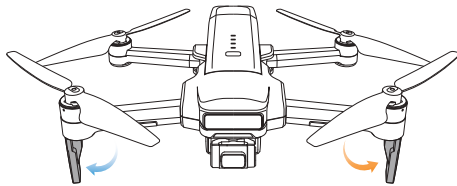

Please unfold the two front landing gears separately.

2.2 Pre-Flight Preparations >>

Camera Cover

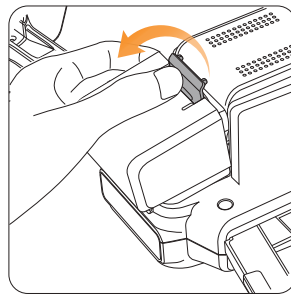

Loosen the buckle on the camera cover.

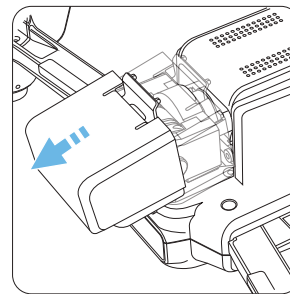

Gently pull the cover toward the front of the drone.

- ⚠ • Please remove the gimbal cover cover before you turn on the drone.
- Put the gimbal cover back in place when the drone is not in use.

2.2 Pre-Flight Preparations >>

Propellers

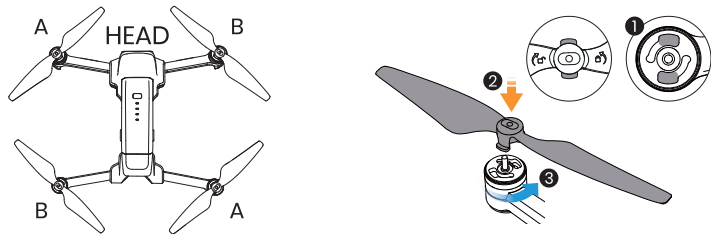

Installation: First, identify the correct A/B propellers. To install a propeller, align it with the motor shaft's clamp. Press down on the propeller and rotate it in the direction shown by the lock icon "🔒" to secure it.

Removal: To remove, press down on the propeller and rotate it in the direction shown by the unlock icon "🔓" on the propeller.

- ⚠️ • Ensure that you attach the propeller to the appropriate motor shaft. Failure to do so will result in the propeller not being installed correctly.
- Please check that the propellers are properly installed and tightened before each flight.
- Exercise caution when attaching/detaching the propellers to prevent any cuts or injuries.

2.2 Pre-Flight Preparations >>

Drone Battery

• Installation:

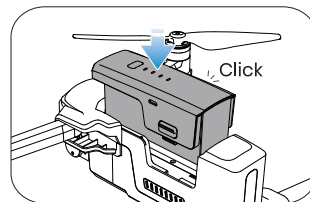

Insert the battery into the battery compartment of the drone. Make sure it is installed securely and that the battery buckles are clicked into place.

• Removal:

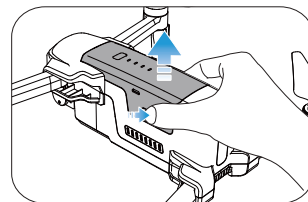

Press the battery buckles on the sides of the battery to remove the battery from the compartment.

- 💡 • Before installing the battery, please check if it has a detachable insulation pad/band. If yes, remove it.
- Please make sure that the battery is firmly installed. Otherwise, the flight safety of your drone may be affected. The drone may crash due to a power-cut during the flight.
- Only install/remove the battery when it is powered off.

2.2 Pre-Flight Preparations >>

TF Card

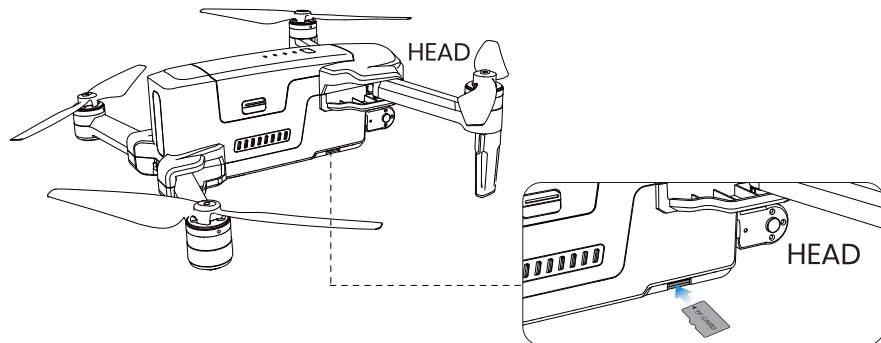

To store your photos and videos, insert a TF card (TF card not included) into the slot before inserting the battery into the drone. This drone supports TF card (Class 10 or above) with capacities up to and including 128GB.

2.3 Pre-Flight Checklist >>

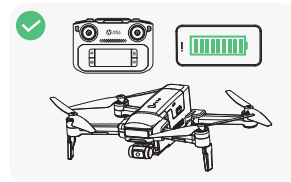

Make sure the transmitter, the cellphone and the drone battery are fully charged.

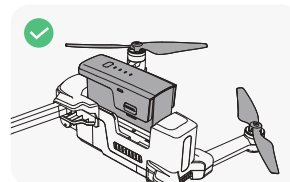

Make sure the drone battery and the propellers are installed securely.

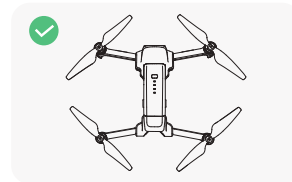

Make sure the drone arms are fully expanded.

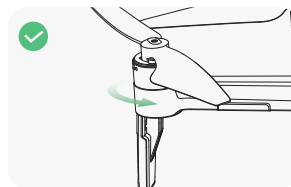

Make sure that there is nothing obstructing the motors.

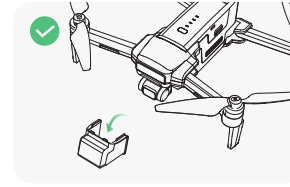

Make sure the camera cover is removed.



Make sure you use accessories provided by this company.

2.4 Flight >>

Pairing

- All of the operations shown in this manual are demonstrated using MODE 2.
- Make sure that you go outdoor to an open area to operate the drone.

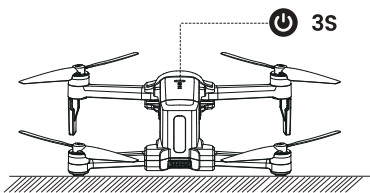

1 Turning on the drone

Press and hold the Power Switch  for 3 seconds to turn on the drone. **Place it on a level surface with its head pointing forward.** The drone status indicator starts to blink red. The drone is now waiting to be paired.

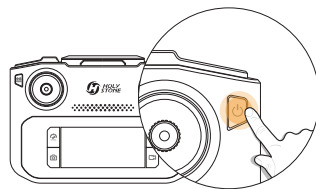

2 Turning on the transmitter

Short press the power switch () once, then press and hold for 3 seconds to turn it on.

- Short pressing the button once will only display the battery level.

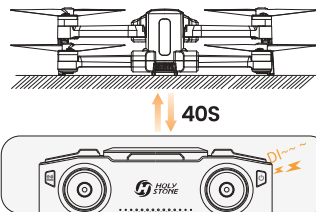

3 Auto-Pairing

It takes about **40 seconds** to pair the transmitter with the drone. During the pairing, the transmitter will continue to beep. Finally, it will long beep once and the transmitter signal strength () on the LCD screen is full and glowing, indicating that the pairing is complete.

2.4 Flight >>

App Connection

- 1 Cellphone connection:** Pull out the phone holder. Select the appropriate connection cable (Type-C, Micro-USB, or Lightning) from the package. Connect the end marked with a transmitter icon () to the transmitter and plug the other end into your cellphone.

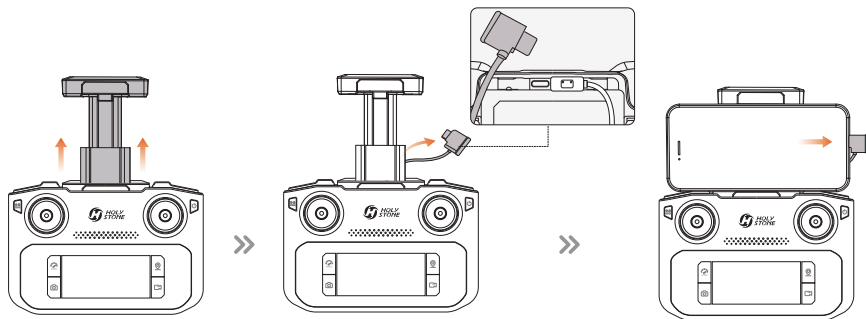

- 2** Run the "HS FLY" app and open up the live-feed interface.



HS FLY App



When using an Android phone, please choose "charge only" when the cellphone asks you to choose a connection mode. Other options may cause the connection to fail.

2.4 Flight >>

Compass Calibration

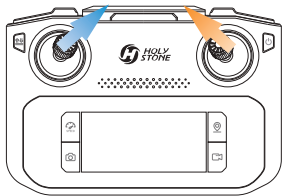

- **STEP 1**

Push both joysticks **towards the inner, upper corners** simultaneously to start the compass calibration.

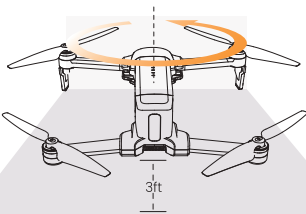

- **STEP 2**

Rotate the drone horizontally (**keeping it parallel to the floor**) until the transmitter beeps once.

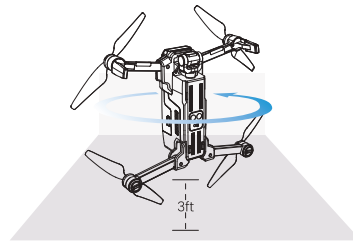

- **STEP 3**

Point the head of the drone **upward and rotate it** till the transmitter beeps again. The compass calibration is complete.



- To ensure a stable flight, we recommend that pilots perform a compass calibration before each flight.
- We recommend that the pilot hold the drone approximately 3 ft above the ground while performing the compass calibration.
- **DO NOT** calibrate the compass in locations where magnetic interference may occur, such as close to magnetite deposits or large metallic structures such as parking structures, steel reinforced basements, bridges, cars, or scaffolding.
- **DO NOT** carry objects (such as mobile phones) that contain ferromagnetic materials near the drone during calibration.

2.4 Flight >>

GPS Signal Search

 Please don't use the GPS mode when you are indoors.

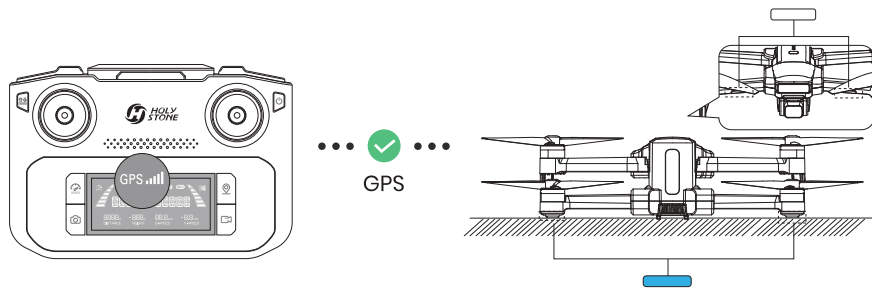

After calibrating the compass, put the drone on a flat surface. Make sure there are no external sources of signal interference around.

The drone will automatically perform a search for GPS signals. The drone has successfully located the GPS signal when its front indicator turns solid white and its rear indicator turns solid blue. The GPS signal strength (GPS ) will be at its maximum when the LCD screen is full and glowing.



- If the indicator lights on the drone keep blinking White (front) and Blue (rear), it indicates the drone is searching for GPS signals.
- If the GPS signal is weak, or if you plan to fly the drone indoors, press and hold the  button on the transmitter for 2 seconds to exit GPS mode for a proper takeoff. The LCD screen will then display "ATTI MODE", indicating that the drone has entered Attitude Mode. In this mode, the drone can take off, but please be aware that all GPS-related functions will be unavailable.

2.4 Flight >>

Unlocking the Motors



Push both of the joysticks simultaneously toward the inner, lower corners. The motors start to spin, the drone is unlocked.

Lightbulb Locking: If no command is given, the motors will lock themselves automatically 20s after they are unlocked. You can also push both of the joysticks to the inner corners to manually lock them.

Takeoff/Landing

Lightbulb Remember to unlock the motors before takeoff.



Takeoff Short press the  button, the drone slowly takes off. You can control the drone with the joysticks now.

Landing When the drone is in the air, short press the  button. The drone slowly descends to the ground.

Lightbulb When operating the drone, it's important to periodically adjust the orientation and distance between the transmitter and the drone to ensure that the drone always remains within the optimal communication range.

Optimal Reception Range:

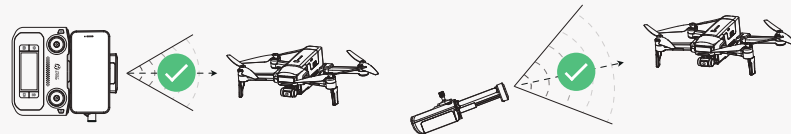

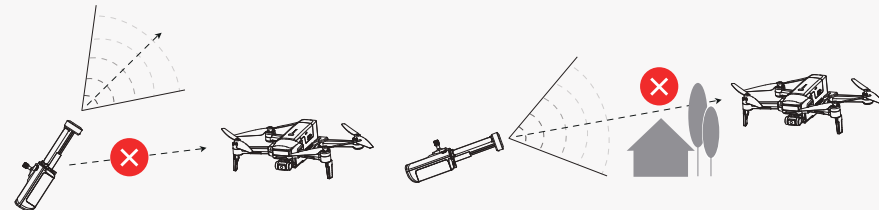

Weaker Signal:

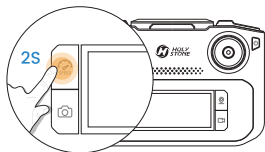

3.1 Flight Functions >>

Cruise Control



Long press the  button to enter the cruise control function. The drone will automatically fly in a straight line at the same speed it was going before it entered cruise control. Long press the  button again to exit the function.

Gimbal Dial





The 3-axis gimbal stabilizes the camera, allowing you to capture clear, stable images and video. The control tilt range is -80° to 0° . Use the gimbal dial ( ANGLE ) to control the tilt of the camera.

3.1 Flight Functions >>

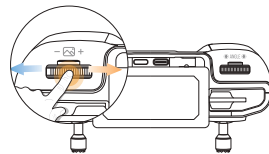
Zoom



To zoom in, scroll the zoom dial + to the right. The LCD screen displays "ZOOM IN."
To zoom out, scroll the zoom dial + to the left. The LCD screen displays "ZOOM OUT."

Emergency Stop

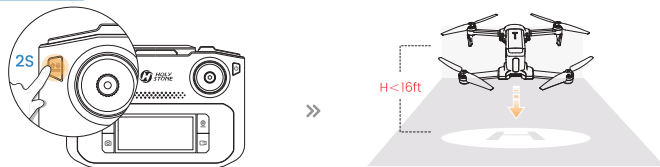

Hold the  button for 2 seconds to use Emergency Stop. This function only works when the drone's altitude is lower than 16ft.

 The Emergency Stop function should only be used in case of emergency during the flight to avoid any damage or injury.

3.1 Flight Functions >>

Speed Switch

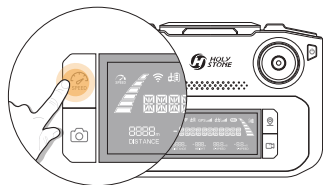

Short press the  button once to switch speed.

 The normal mode is the default setting.

● Low:



The transmitter beeps once.
The LCD screen displays
"CAMERA MODE" .

● Middle:



The transmitter beeps twice.
The LCD screen displays
"NORMAL MODE" .

● High:





The transmitter beeps 3 times.
The LCD screen displays
"SPORT MODE" .

3.1 Flight Functions >>

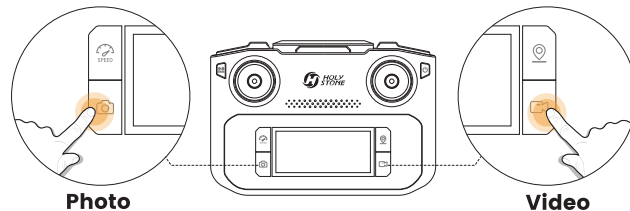
Photo/Video



- 1 Short press the  button on the transmitter. The **REC** on the LCD screen flashes once, which means that you have successfully taken a photo.
- 2 Short press the  button on the transmitter. The **REC** on the LCD screen starts to blink, which means the camera is recording. Short press the button again will stop video recording.

 During the recording, the "Take Photo" function is disabled.

3.1 Flight Functions >>

Return to Home

- The Return to Home (RTH) function brings the drone back to the recorded Home Point. This function can only be triggered when the drone is in GPS mode.
- The drone's default home point is the location where it first receives a strong GPS signal (When this occurs, the GPS signal strength (GPS signal strength icon) will be on the LCD screen is full and glowing). The drone will record its takeoff position at that moment as the home point. During flight, if the drone lands at a new location, the position of the next takeoff will become the newly recorded home point.

* RA: the Return Altitude set in the app setting. (The default RA is 65 ft.)

1 Smart RTH:

Short press the  button to activate Smart RTH. The drone will fly back to the last recorded Home Point.

During Smart RTH, the transmitter will keep on beeping. Short press the  button again to exit Smart RTH.

2 Failsafe RTH:

The Failsafe RTH will be activated when:

1. The drone receives a strong GPS signal; and

2. There is a pre-recorded Home Point; and
3. The connection between the transmitter and the drone is lost; and
4. The compass has no interference.

Once the Failsafe RTH is activated, the drone will start to fly back to the pre-recorded Home Point automatically. If the connection between the drone and the transmitter is re-established during the Failsafe RTH procedure, the pilot can manually end the RTH procedure by pressing the  button again, thus regaining control of the drone.

 The following are two possible returning procedures for Smart RTH and Failsafe RTH:

a Flight altitude \geq RA: When the drone's current altitude is higher than or equal to RA, the drone will maintain its current altitude, fly back above the Home Point, then descend to the ground.

b Flight altitude $<$ RA: When the drone's current altitude is lower than RA, the drone will first ascend to RA, fly back above the Home Point, then descend to the ground.

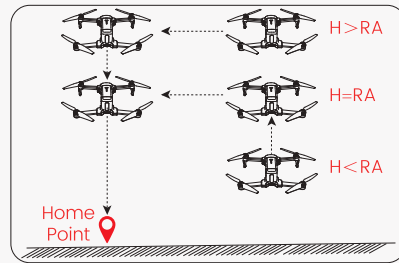

3.1 Flight Functions >>

Return to Home

3 Low Voltage RTH :

When the flight battery is too low or there is not enough power to return home, the pilot should land the drone as soon as possible to avoid damage to the drone or other hazards.

To prevent unnecessary risks due to insufficient battery power, the low voltage RTH function will be automatically triggered when the drone battery is low. According to the remaining power, there are two scenarios:

The First Stage of Low Voltage RTH: The drone automatically flies back and hover over the Home Point. While the drone is returning, the transmitter emits a continuous beep. The LCD screen displays "GOING HOME."

After the drone returns, you will be restricted to fly it within a "safety zone", which is centered around the Home Point and has a radius of 328 ft and a height of 98 ft. The drone will not be able to exit this zone.

The Second Stage of Low Voltage RTH: The drone returns directly to the Home Point and initiates an automatic landing.

- ⚠ · During the RTH procedure, the drone can NOT avoid obstacles.
- If the GPS signal is weak or unavailable, the RTH cannot be activated.
- Always keep the transmitter ON during flights. Turning it off will trigger the Failsafe RTH due to a lost connection.





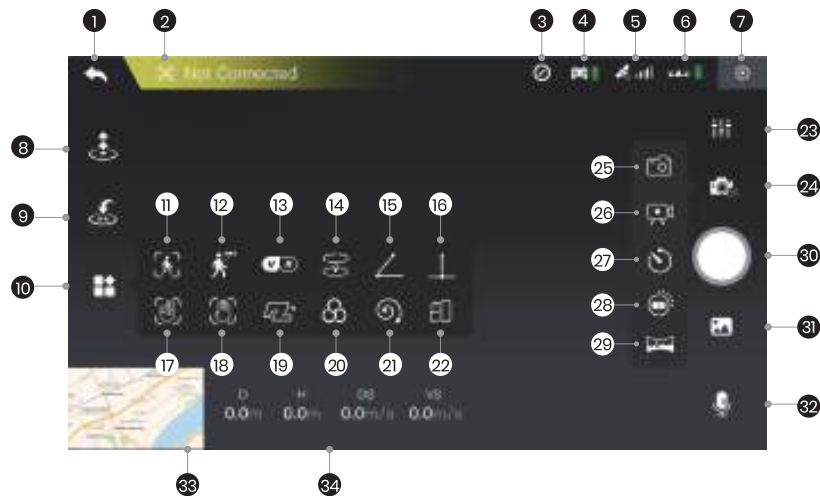





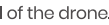

3.2 APP Functions >>

The Interface

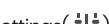
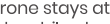
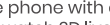

3.2 APP Functions >>

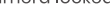
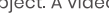
The Interface

- 1 Homepage (): Tap this icon to return to the main menu.
- 2 System Status (): Displays the flight status and various warning messages.
- 3 Interference Index of Compass (): Displays the current level of electromagnetic interference. "0" means no interference, "1000" means max. interference.
- 4 Transmitter Battery Level (): Real-time display of the current battery level of the transmitter.
- 5 GPS Signal (): Displays current GPS signal strength.
- 6 Drone Battery Level (): Real-time display of the current battery level of the drone.
- 7 Settings (): Tap to enter the setting interface. Alter settings for flight height/distance, return altitude, PTZ parameters, etc.
- 8 Takeoff/Landing (): Tap the icon, follow the instructions in the prompt box to takeoff/land.
- 9 Return to Home (): The drone returns to the last recorded Home Point.
- 10 Multi-functions ()
- 11 Image Follow (): After selecting a target, the camera will always point towards it no matter how the target moves. The position of the drone in the air remains unchanged. (The target should not move too fast.)
- 12 GPS Follow (): The drone stays at a distance from the operator and follows the GPS position of the paired mobile phone.
- 13 VR Screen-Split (): Pair the mobile phone with a pair of VR glasses (not included) first. Then use this function to watch 3D live feed in real-time.
- 14 Point of Interest (): The drone flies around a point.
- 15 Catapult (): The drone flies backward and ascends, with the camera locked on the subject. A video is made during this.
- 16 One-key Ascension (): The drone ascends with the camera locked on the subject. A video is made during this.
- 17 Gesture Selfie (): When in this mode, you can trigger the shutter of the drone camera by holding a "V" -sign near your face. (The drone camera should be pointing to your face.)
- 18 Gesture Selfie video (): When in this mode, you can trigger the shutter of the drone camera by holding your palm near your face. (The drone camera should be pointing to your face.)
- 19 TapFly (): The drone flies along the flight path you draw on the screen of the mobile phone.
- 20 Camera Filter ()
- 21 Spiral Up (): The drone ascends and spiral around the subject. A video is made during this.
- 22 Portrait (): The shooting mode will turn from landscape to portrait.
- 23 Camera Settings (): Tap to access and configure camera parameters.

3.2 APP Functions >>

The Interface

- 24** Shooting Mode (📷): Tap to use the photo function.
- 25** Take Photo (📷): Tap to use the photo function.
- 26** Record Video (📹): Tap to use the record function.
- 27** Time-lapse (⌚): Videos captured using this feature will be played back at a faster speed. You can select the playback rate as needed.
- 28** Slow Motion (🎥): Videos captured using this feature will be played back at a slower speed. You can select the playback rate as needed.
- 29** Panorama (🌄): Tap to use the Panorama function.
- 30** Shutter (⬛ / 📷):
- 31** Album (🖼️): Tap to preview photos and videos taken by the drone camera.
- 32** Voice Recording (🎤): Record sounds and voices with your mobile phone while shooting videos.
- 33** Map (🗺️): Tap the Mini Map to switch between Camera View and Map View.
- 34** Flight Parameters
- Flight Distance ($\frac{D}{N/Am}$): Horizontal distance from the Home Point.
 - Flight Altitude ($\frac{H}{N/Am}$): Vertical distance from the Home Point.
 - Horizontal Speed ($\frac{DS}{N/Am/s}$): Drone's speed in the horizontal direction.
 - Vertical Speed ($\frac{VS}{N/Am/s}$): Drone's speed in the vertical direction.

3.2 APP Functions >>

Beginner Mode

The beginner mode is the default operating mode. When in the Beginner mode:

- 1 The flight distance can not exceed 98 ft.
- 2 The flight altitude can not exceed 98 ft.
- 3 The return altitude during RTH is 65ft.

 >>
**Flight Settings
 On APP**

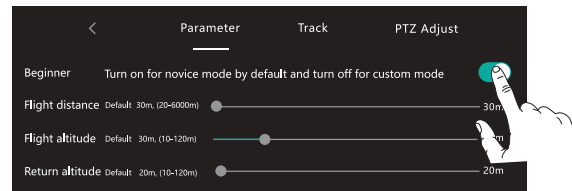





If you want to alter the above-mentioned parameters, please first turn off the beginner mode. You can go to the "Settings" to modify these parameters.

3.2 APP Functions >>

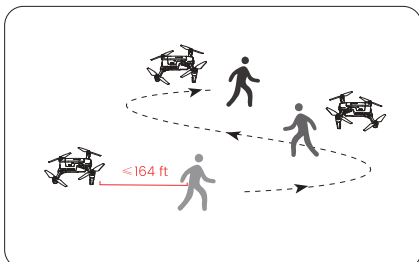
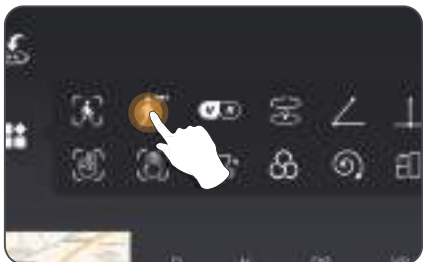
GPS Follow

When the GPS Follow function is enabled, the drone will track your movement by following the GPS signal on your cellphone. (Please make sure that the connection between the drone and the transmitter is strong and stable.)







- 1 Make sure that the drone's flight distance is within 164 ft. Tap the  icon first, then select the  icon.
- 2 Follow the prompt box to enter the GPS Follow function — the drone will now follow your cellphone's coordinates.
- 3 To exit GPS Follow function, simply tap the  icon on the app interface again.

- ⚠ The GPS Follow function can only be used if the flight distance is within 164 ft.
- Follow Me function may be difficult to activate if the mobile phone's GPS signal is too weak. This could be caused by signal interference from surrounding buildings, trees, mobile network congestion etc.
- Please use this function in an open area and be mindful of your surroundings. The drone is NOT equipped with obstacle avoidance.

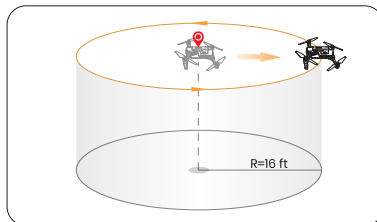
3.2 APP Functions >>

Point of Interest





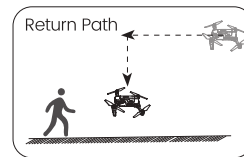
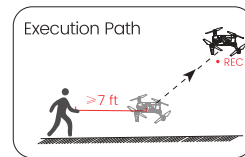

- 1 Tap the  icon first, then select the  icon, and follow the prompt box to activate the Point of Interest function. You can set the circling radius in the prompt box.
- 2 The moment you activate this function, the drone will record its current flight position as the "point of interest". It will then continuously circle around that point clockwise. (default radius: 16 ft)
- 3 To exit Point of Interest mode, simply tap the  icon again.

3.2 APP Functions >>

Catapult





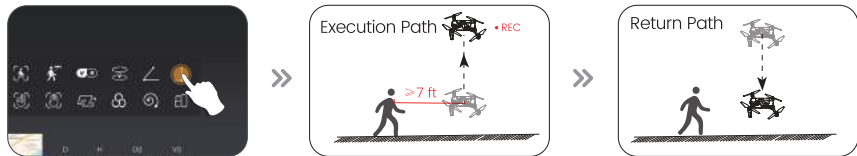

- 1 Make sure that the drone is a least 7 ft away from the target. Adjust the camera angle so it points directly to the target.
 - 2 Tap the  icon, then tap . Swipe in the prompt box to confirm.
 - 3 The drone will automatically start recording, while flying about 82 ft away from the target.
 - 4 After this, it will fly back to the starting point.
 - 5 Tap the  icon again, or push the right joystick to exit this function.
-  Make sure there is no obstacles or people in the flight path of the drone. In case of emergency, push the right joystick to exit Catapult.

3.2 APP Functions >>

One-key Ascension



- 1 Please make sure that the drone is at least 7 ft away from the target. Adjust the camera angle so it points directly to the target.
- 2 Tap the  icon, then tap . Swipe in the prompt box to confirm.
- 3 The drone will start recording and climb 49 ft upwards.
- 4 After this, the drone will fly back to the starting point.
- 5 Tap the  icon again, or push the right joystick to exit this function.



 Make sure there are no obstacles or people in the flight path of the drone. In case of emergency, push the right joystick to exit One-key Ascension.

3.2 APP Functions >>

TapFly

When using the TapFly, it is recommended to enlarge the map before drawing the flight path.







- 1 Tap the  icon, then Tap .
- 2 You can tap a dozen of times (but no more than 16) on the phone screen to create a flight path. Hit "GO" to submit the route. The drone will then fly along the path created by connecting the points you tap in order.
- 3 You can exit TapFly by tapping the  icon again, or pushing the right joystick in any direction.

 · DO NOT fly the drone towards people, animals, or small/thin objects (e.g. tree branches and power lines) or transparent objects (e.g. glass or water).
· The actual flight path and the path you draw may not align perfectly.

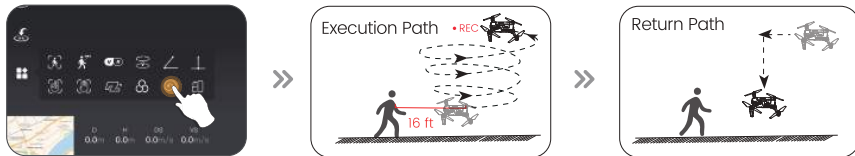
3.2 APP Functions >>

Spiral Up







- 1 Make sure that the drone is about 16 ft away from the target. Adjust the camera angle so it points directly to the target.
- 2 Tap the  icon, then tap . Swipe in the prompt box to confirm.
- 3 The drone will automatically ascend and circle around (max. radius: about 49 ft) and start recording.
- 4 After this, it will fly back to the starting point.
- 5 Tap the  icon again, or push the right joystick to exit this function.

 Make sure there is no obstacles or people in the flight path of the drone. In case of emergency, push the right joystick to exit Spiral Up.

3.2 APP Functions >>

Time-lapse







- 1 Tap the  icon, then tap  to use time-lapse shooting.
- 2 Swipe to choose the video playback speed, tap again to confirm.
- 3 Tap the shutter , the time-lapse shooting begins.
- 4 Tap the shutter  again to stop recording.

3.2 APP Functions >>

Slow Motion





- 1 Tap the  icon, then tap  to use slow motion shooting.
- 2 Swipe to choose the video playback speed, tap again to confirm.
- 3 Tap the shutter , the slow motion shooting begins.
- 4 Tap the shutter  again to stop recording.

3.2 APP Functions >>

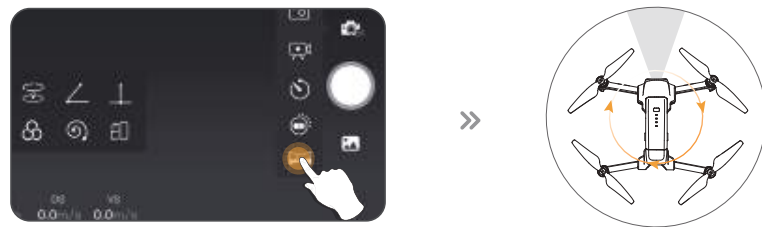
Panorama



- 1 Tap the  icon, then tap  to use the Panorama function.
- 2 Tap the shutter .
- 3 The drone will maintain its current position and rotate. A panorama picture is then auto-generated and saved to the album. A prompt box will pop up when this is done.

3.3 Stabilization Function >>

Optical Flow Positioning

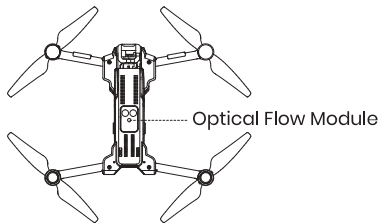

The Optical Flow Positioning System consists of a camera module, which acquires the position information of the drone through visual images to ensure precise positioning of the drone.

! The precision of the Optical Flow Positioning System is easily affected by the light intensity and features of the surface textures. Once the image sensor is not available, your drone will switch on the altitude-hold function automatically. Please exercise utmost caution when operating the drone under these circumstances:

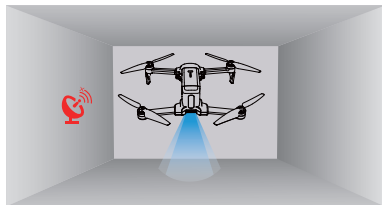

The Optical Flow Positioning System is typically used in an indoor environment when the GPS signal is weak or unavailable. The optimal usage height for Optical Flow Mode is **1.6–9.8 ft**.

When in a dark environment, you can turn on the lights by pressing the  button on the transmitter to facilitate the image positioning function.

- Fly over surfaces without clear patterns or textures.
 - Fly over extremely dark or bright surfaces.
 - Fly in an area where the lighting changes dramatically and frequently.
 - Fly over moving surfaces or objects. (e.g., above crowds, above bushes or grasses swayed by strong winds).
 - Fly over water or transparent surfaces.
 - Fly over highly light reflective surfaces. (e.g., mirrors).
 - Fly over monochrome surfaces (e.g. pure black, red, or green).
 - Flying over surfaces with repeating identical patterns or textures (e.g., tiles with the same design).
 - Flying speed should be controlled not to be too fast.
- Keep sensors clean at all times.
 - DO NOT scratch or tamper with the sensors. DO NOT use the aircraft in dusty or humid environments.
 - Make sure that the light is bright enough and the surface is with clear textures so that the Optical Flow Positioning can acquire the movement information through recognizing the ground textures.

3.3 Stabilization Function >>

Altitude-Hold Function

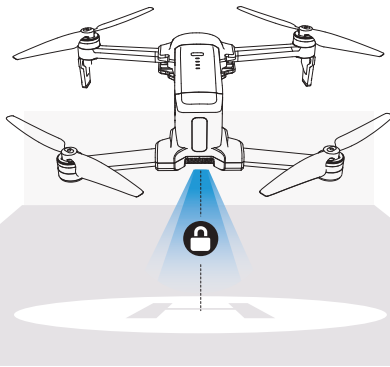

The drone is designed with an altitude-hold function to maintain its altitude after releasing the left joystick. (The left joystick will automatically spring back to the middle)

4.1 Specifications >>

• DRONE :

Model: HS600D	Weight: 603g/21.3oz
Max Flight Time (per battery) : 40 minutes <small>(in a windless environment)</small>	Max Flight Height: 394ft/120m
Max Wind Speed Resistance: 7.9m/s	Max Takeoff Altitude: 9842ft/3000m
Operating Temperature Range: 32° to 104°F (0° to 40°C)	
Size: 202*95*83 mm (folded)	375*258*83 mm (unfolded)

• DRONE BATTERY :

Capacity: 3500mAh	Voltage: 11.1V
Battery Type: Lithium-ion Polymer Battery	Rated Power: 38.85Wh
Charging Temperature Range: 41° to 104°F	Charging Time: about 2 hours

• USB CHARGING CABLE :

Input: 5V/3A	Rated Power: ≤15W
--------------	-------------------

4.1 Specifications >>

• GIMBAL:

Stabilization: 3-axis (tilt, roll, pan)	Controllable Range: about -80° to 0°
---	--------------------------------------

Mechanical Range: Tilt -100° TO +70°, Roll -35° TO +35°, Pan -15° TO +15°

• CAMERA:

Operating Frequency: 5745-5825MHz	Max Transmission Distance: 19685ft/6000m <small>(outdoor and unobstructed)</small>
-----------------------------------	---

Photo Resolution: 8000×6000P <small>(when stored in TF card)</small>	3840×2160P <small>(when stored in cellphone)</small>
---	---

Video Resolution: 3840×2160P@30fps <small>(when stored in TF card)</small>	1280×720P@30fps <small>(when stored in cellphone)</small>
---	--

Photo Formats: JPEG	Video Formats: MP4
---------------------	--------------------

Supported TF Cards: Supports a TF Card <small>(Class 10 or above)</small> with capacity of up to 128 GB

Supported File Systems: FAT32

4.1 Specifications >>

• TRANSMITTER:

Operating Frequency: 5745-5825MHz	Charging Time: about 2 hours
-----------------------------------	------------------------------

Max Flight Distance: 19685ft/6000m <small>(outdoor and unobstructed)</small>	Usage Time: about 2.5 hours
---	-----------------------------

Operating Temperature Range: 32° to 104°F	Battery Type: 7.4V 1100mAh Lithium-ion Battery
---	--

4.2 Contact Us >>

Please do not hesitate to contact us if you need further support.



usa@holystone.com (America)
ca@holystone.com (Canada)
eu@holystone.com (Europe)
au@holystone.com (Australia)



+1 (833) 766-4733



www.holystone.com

4.3 Troubleshootings >>

Issue	Possible Causes	Suggested Solutions
Gimbal cannot be adjusted.	Gimbal protection activated due to not removing the gimbal cover before powering on.	Ensure the gimbal cover is removed before powering on.
	Drone is not in a level position.	Place the drone on a level surface before turning it on and wait for the gimbal to complete its self-check.
	In compass calibration mode.	The gimbal doesn't function during compass calibration. After calibration, place the drone on a level surface and wait for the gimbal to stabilize and re-center.
	Drone placed on uneven surfaces like grass or sand.	Position the drone levelly on a landing pad or switch to another even surface. Ensure there's ample space below the gimbal and avoid obstacles that might affect its stabilization.
Unstable flight or abnormal posture.	GPS signal instability due to flying near buildings or in areas with obstructions.	Operate the drone in open spaces free from obstructions.
	Compass interference	1. Manually land the drone immediately and recalibrate the compass. 2. Try operating in a different location, ensuring you're away from buildings, power lines, and signal towers.
	Propeller deformation or damage.	Replace with new propellers.
Video lag or limited transmission range	Interference with the video transmission signal.	Operate the drone in open areas away from potential obstructions like buildings, power lines, and towers to minimize interference.
	The transmitter and mobile device are not oriented towards the drone.	Ensure the transmitter and mobile device are facing the drone's direction to optimize signal strength.
	Overly rapid joystick movements during flight control.	Use gentle, steady joystick movements during flight.
	Phone performance issues.	Close any unused apps running in the background to optimize your phone's performance.

4.4 Compliance Information >>

FCC Notice:

This device complies with part 15 of the FCC Rules. Operation is subject to the following two conditions:

- (1) This device may not cause harmful interference, and
- (2) This device must accept any interference received, including interference that may cause undesired operation.

The Supplier's Declaration of Conformity is available at the following address:

https://www.holystone.com/Download/US/HS600D_FCC_sDoC.pdf

This equipment has been tested and found to comply with the limits for a Class B digital device, pursuant to part 15 of the FCC Rules. These limits are designed to provide reasonable protection against harmful interference in a residential installation. This equipment generates, uses and can radiate radio frequency energy and, if not installed and used in accordance with the instructions, may cause harmful interference to radio communications. However, there is no guarantee that interference will not occur in a particular installation. If this equipment does cause harmful interference to radio or television reception, which can be determined by turning the equipment off and on, the user is encouraged to try to correct the interference by one or more of the following measures:

- Reorient or relocate the receiving antenna.
- Increase the separation between the equipment and receiver.
- Connect the equipment into an outlet on a circuit different from that to which the receiver is connected.
- Consult the dealer or an experienced radio/TV technician for help.

Changes or modifications not expressly approved by the party responsible for compliance could void the user's authority to operate the equipment.

RF Exposure:

The equipment complies with FCC radiation exposure limits set forth for an uncontrolled environment. This device should be installed and operated with minimum distance 20cm between the radiator & your body. This part belongs to the drone.

This equipment complies with FCC/ISED radiation exposure limits set forth for an uncontrolled environment. End user must follow the specific operating instructions for satisfying RF exposure compliance. This transmitter must not be co-located or operating in conjunction with any other antenna or transmitter.

The portable device is designed to meet the requirements for exposure to radio waves established by the FCC/ISED. These requirements set a SAR limit of 1.6 W/kg averaged over one gram of tissue.

IC Notice:

This device is restricted to indoor use when operating in the 5150 to 5250 MHz frequency range.

This device complies with Industry Canada license-exempt RSS standard(s). Operation is subject to the following two conditions:

- (1) this device may not cause interference, and
- (2) this device must accept any interference, including interference that may cause undesired operation of the device.

CAN ICES-003 (B):

Avis d' Industrie Canada

Le présent appareil est conforme aux CNR d'Industrie Canada applicables aux appareils radio exempts de licence. L'exploitation est autorisée aux deux conditions suivantes :

- (1) l'appareil ne doit pas produire de brouillage, et
- (2) l'utilisateur de l'appareil doit accepter tout brouillage radioélectrique subi, même si le brouillage est susceptible d'en compromettre le fonctionnement.

CAN NMB-003 (B):**RF Exposure**

Radiation Exposure Statement:

The device is compliance with RF exposure guidelines, users can obtain Canadian information on RF exposure and compliance. The minimum distance from body to use the device is 20cm.

Le présent appareil est conforme

Après examen de ce matériel aux conformité ou aux limites d' intensité de champ RF, les utilisateurs peuvent sur l' exposition aux radiofréquences et compliance d' acquérir les informations correspondantes. La distance minimale du corps à utiliser le dispositif est de 20cm.

EU RF Power (EIRP): <14 dBm (5745-5825MHz)**Caution:**

The max operating of the EUT is 40°C. and shouldn't be lower than 0°C.

The device complies with RF specifications when the device used at 0mm from your body.

Declaration of Conformity.

We, Xiamen Huoshiquan Import & Export CO., LTD hereby, declare that the essential requirements compliance with the Directive 2014/53/EU, the RoHS Directive 2011/65/EU and Safety Directive 2009/48/EC have been fully fulfilled on our product with

Indication Below:

Product Name: REMOTE CONTROL MODEL/RADIO CONTROLLED

Model/Mark: HS600D/HOLYSTONE

The Statement of compliance is available at the following address:

http://www.holystone.com/Download/CE/HS600D_EU_DOC.pdf

This product can be used across EU member states.

Manufacturer Information:

Manufactured by Xiamen Huoshiquan Import & Export CO.,LTD

Address: Unit 1, Room 501, Hongxiang Building, No.258 Hubin Nan Road, Siming District, Xiamen, China

+1 (833) 766-4733

MTOM Statement

HS600D is a quadrotor drone. The MTOM of HS600D is 603g, including the propellers, the Flight Battery, which is compliant with C1 requirements.

Users must follow the instructions below to comply with the MTOM C1 requirements. Otherwise, the drone cannot be used as a C1 aircraft:

1. DO NOT add any payload to the aircraft except the items listed in the List of Items including qualified accessories section.
2. DO NOT use any non-qualified replacement parts, such as flight batteries or propellers, etc.
3. DO NOT retrofit the aircraft.

List of Items including qualified accessories

1. HS600D Propellers (5.1 g each propeller)
2. HS600D Flight Battery (approx. 246 g)
3. HS600D TF card (approx. 0.3 g)

List of Spare and Replacement Parts

1. HS600D Propellers (5.1 g each propeller)
2. HS600D Flight Battery (approx. 246g)

List of Safe Guards

Below is the list of the mechanical safeguards and operation safeguards for HS600D.

1. Emergency Stop function can be performed to stop the motors in case of an emergency. Refer to the Emergency Stop section for details.
2. The Return to Home (RTH) function. Refer to the GPS Return to Home section for details.
3. The Optical Flow Positioning. Refer to the Optical Flow Positioning section for details.
4. Prevent the drone from flying in restricted airspace. Refer to the Flight Environment Requirements section for details.



MADE IN CHINA(CN)