



U Match

SLIM CONCEALED DUCT UNIT OWNER'S MANUAL

Models:

UMAT18HP230V1AD

UMAT24HP230V1AD

UMAT30HP230V1AD

UMAT36HP230V1AD

UMAT42HP230V1AD

UMAT48HP230V1AD



Thank you for choosing a U-Match Slim Concealed Duct Air Conditioning & Heating System!

You can feel confident in your selection because the same pride in craftsmanship and engineering knowledge that goes into millions of other Gree installed products worldwide has gone into your unit.

Please read this owner's manual carefully before operation and retain it for future reference.

Table of Contents

<i>Introduction</i>	<i>2</i>
<i>Nomenclature</i>	<i>3</i>
<i>Safety Precautions</i>	<i>4-5</i>
<i>System Schematic</i>	<i>6</i>
<i>System Functions</i>	<i>7-9</i>
<i>Operating Instructions</i>	<i>10-22</i>
<i>Care and Cleaning</i>	<i>23</i>
<i>Troubleshooting & Diagnostic Codes</i>	<i>24</i>
<i>Energy Saving Tips</i>	<i>25</i>
<i>Warranty</i>	<i>Back</i>

INTRODUCTION

Superior Design for Superior Performance

Compact and powerful, this Gree U-Match Slim Concealed Duct indoor unit offers the ultimate in flexibility and discretion. It is designed to be concealed above suspended ceilings or within open closet spaces to deliver conditioned air via ducting and suitable ceiling or wall grilles. This arrangement provides immense flexibility, in terms of both the distribution of conditioned air and the type of grille or diffuser that best complements any room's styling. Your unit is easily operated from the wall-mounted wired Tether Controller.

Like all Gree systems, this unit provides quiet comfort and energy efficient heating and cooling. For many residential and light commercial applications, it is the ideal solution to balance comfort, efficiency and ease of use.

The Slim Concealed Duct unit works in conjunction with the U-Match outdoor compressor section, featuring Gree's exclusive G-10 Inverter technology. The Inverter constantly adjusts compressor speed to save energy, reduce outdoor noise and maintain a steady room temperature, by eliminating the harsh starts and stops of conventional systems.

Thank you for selecting this Gree air conditioner. Before operating your unit, please read this manual carefully and retain it for further reference.

NOMENCLATURE

Indoor unit

Example: UMAT18HP230V1AD

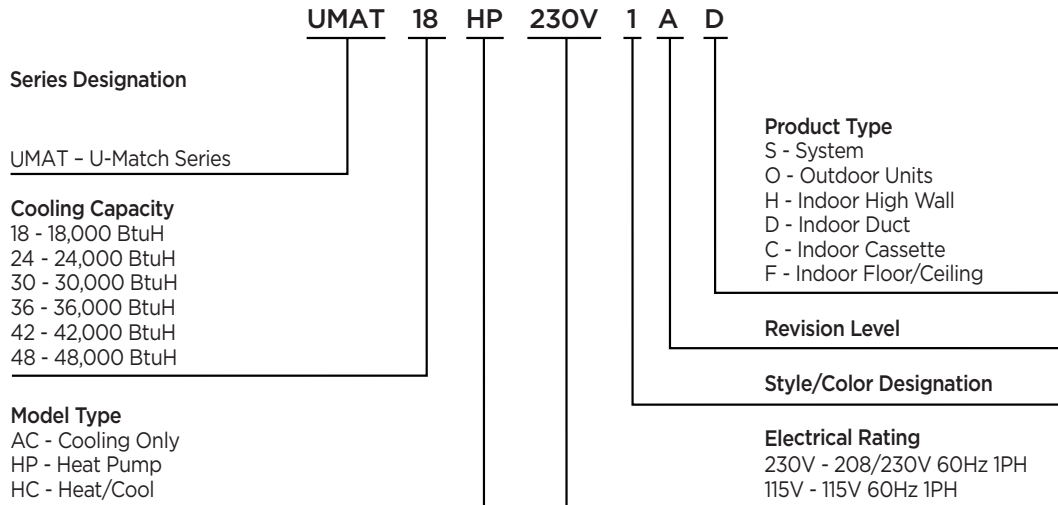

Outdoor unit

Example: UMAT18HP230V1AO

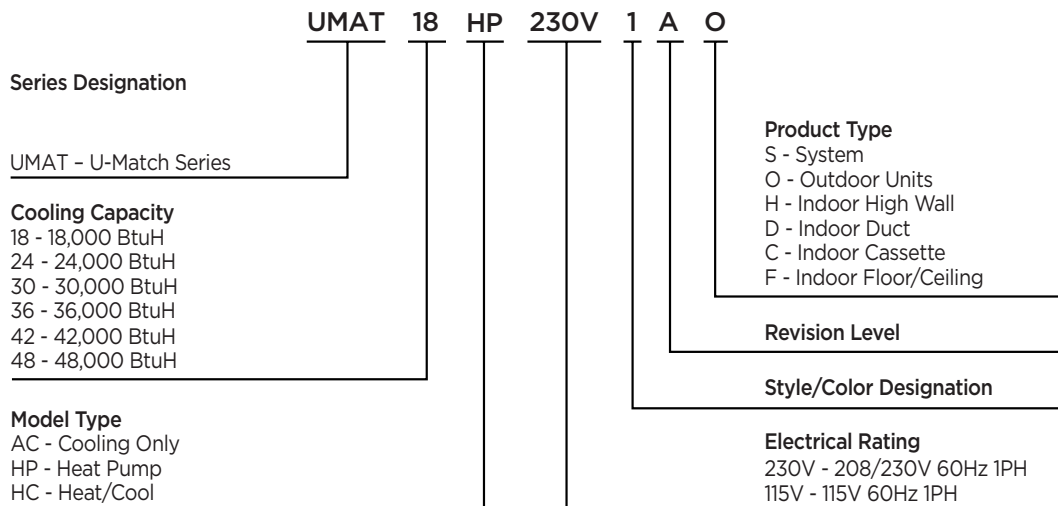

SAFETY PRECAUTIONS

Please read the following before operation.

Recognize safety information.  This is the safety-alert symbol. When you see this symbol on the unit and in instructions or manuals, be alert to the potential for personal injury. Understand these signal words: **DANGER**, **WARNING**, and **CAUTION**. These words are used with the safety-alert symbol.

DANGER identifies the most serious hazards which will result in severe personal injury or death.

WARNING signifies hazards which could result in personal injury or death.

CAUTION is used to identify unsafe practices which may result in minor personal injury or product and property damage.

NOTE is used to highlight suggestions which will result in enhanced installation, reliability, or operation.

NOTE: Your actual air conditioning & heating system and related devices may differ from the images shown in this manual.

WARNING

Heat pumps, air conditioners & heating equipment should be installed, started up, and serviced only by qualified installers and service technicians. Air conditioning, heat pumps and refrigeration systems are hazardous due to high voltage electrical components, high refrigerant pressures, and moving parts.

SAFETY PRECAUTIONS

Please read the following before operation.

WARNING

- *Disconnect electrical power to the indoor and outdoor units before performing any maintenance or cleaning.*
- *Do not attempt to repair the Gree system yourself. Incorrect repairs may cause electric shock or fire. Contact a qualified service technician for all service requirements.*
- *Keep combustible materials away from the unit.*

CAUTION

- *Do not put hands or any objects into the air inlets or outlets. This may cause personal injury or damage the unit.*
- *When cleaning, be careful not to splash water on the unit. Doing this may cause electric shock or damage to unit.*

System Schematic

Indoor Unit

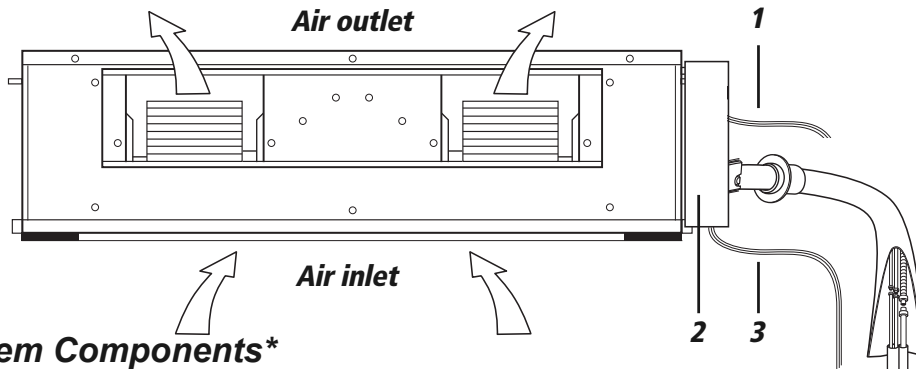

System Components*

1. Indoor Power Supply
2. Electric Box
3. Communication Cable
4. Wired Tether Controller
5. Communication Cable
6. Front Panel
7. Service Cover
8. Liquid Pipe
9. Gas Pipe
10. Drain Hose
11. Outdoor Power Supply

* Not all items included in equipment purchase



Outdoor Unit

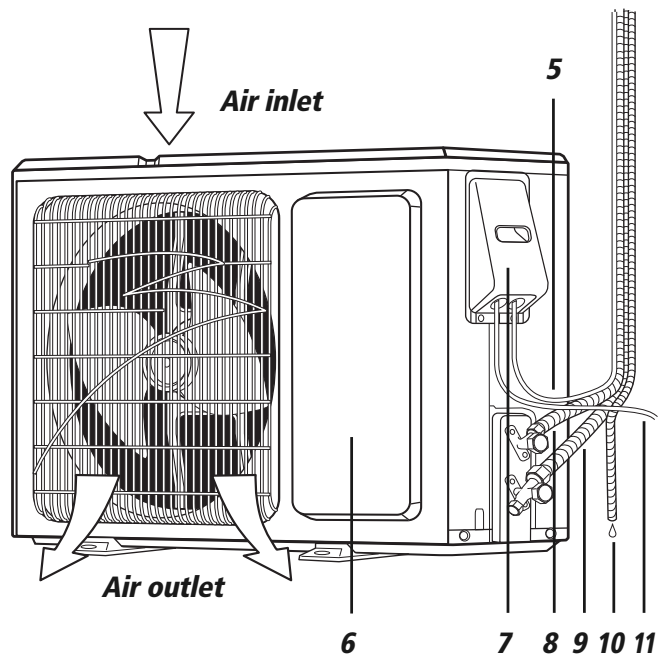

SYSTEM FUNCTIONS

WHISPER QUIET

Not only are the Gree systems energy efficient but they are quiet too. Slim Concealed Duct operates with sound levels starting as low as 28 dB(A).

MULTI FAN SPEEDS

Whether operating in either Cooling or Heating mode, the indoor fan can be set to your choice of three different speeds (Low, Medium or High) to achieve maximum comfort.

BUILT IN CONDENSATE LIFT PUMP

The indoor unit features a built-in drain pump that pumps condensate from the basepan to the drain system.

CONDENSATE SENTRY

The unit's fail-safe mechanism recognizes when there is a high level in the condensate pan and shuts off the system to prevent overflow.

INTELLIGENT PRE-HEATING

The U-Match system guards against the annoying cool air blown into the room in heating mode. The system constantly monitors the discharge air temperature. It will delay the indoor fan until the indoor coil has warmed up to prevent blowing uncomfortable cool air into the room.

TETHER CONTROLLER

The Gree wired Tether Controller mounts to the wall up to 25 feet from the unit. It provides complete control over your unit's operation mode, desired temperature, fan speed, airflow direction and more.

INTELLIGENT DEFROST

The U-Match Intelligent Defrost function increases room comfort and saves energy by eliminating unnecessary defrost cycles. In heating mode, the unit will monitor the outdoor coil for frost buildup. Once frost buildup has been detected, the system will switch into a defrost mode to remove the frost.

In defrost mode the wired Tether Controller display will show "H1" and the indoor fan and outdoor fan will turn off while the system removes frost from the outdoor coil. Once the frost has been removed, the wired Tether Controller display shows room set point and the system will revert back to normal heating operation.

SYSTEM FUNCTIONS

POWER FAILURE MODES

Power interruptions are no problem for the U-Match system. User selections and system parameters are stored in non-volatile memory. These parameters are retained during a power failure. When power is returned, the slim duct system will automatically return to the last operating mode. Or, the system can be set to power up in standby mode.

TURBO MODE

Use Turbo Mode for situations when you wish to achieve the desired room temperature in the shortest possible time. This mode runs the unit at ultra high speeds for quickest results.

CLOCK

Using the 24-hour clock feature, you can control each function in real time, for the most user-friendly operation.

MODE BUTTON

The unit can be set to five different operating modes: HEAT, COOL, DRY, FAN ONLY and AUTO.

NOTE: AUTO MODE has fixed setpoints of 68° F heating and 77° F cooling, which are not adjustable. The system will automatically select heating or cooling to maintain room temperature within this band.

DRY MODE

Select this mode to increase moisture removal during warm humid conditions. In Dry mode the indoor fan will run at low speed during the cooling cycle. When setpoint is reached, the indoor fan will turn off with the compressor.

TIMER MODE

The unit can be programmed to turn ON or OFF after a specific amount of time. The time period is adjustable between one half and 24 hours.

SLEEP MODE

The unit will automatically adjust room temperature during your sleep time. This slight change in temperature will not affect your comfort level due to the natural effects that sleeping has on the body, but it will save on energy consumption and will lower electric bills.

X-FAN MODE

When operating in humid areas, U-Match has a Dry Coil function called X-Fan that will allow the indoor fan to run for a pre-determined amount of time after the unit is turned off (cooling or dry modes) to ensure that additional moisture is removed from coil.

SYSTEM FUNCTIONS

FAHRENHEIT °F / CELSIUS °C

The wired Tether Controller can be set to display in either °F or °C.

SELF-DIAGNOSIS

With an on-board computer using real-time diagnostics, the Gree U-Match system helps to prolong its own life. The automatic diagnosis feature continuously scans for unacceptable operating conditions or malfunctions. If such conditions occur, the system takes corrective action or stops. Error codes are shown on the unit display to facilitate easy troubleshooting and repair.

PRIVACY LOCK MODE

The wired Tether Controller has a Privacy Lock. The Privacy Lock averts unauthorized access or tampering with system settings.

AGENCY LISTINGS

All systems are listed with AHRI (Air conditioning, Heating, and Refrigeration Institute) and are ETL certified per UL Standards.

INTRODUCTION TO THE TETHER CONTROLLER

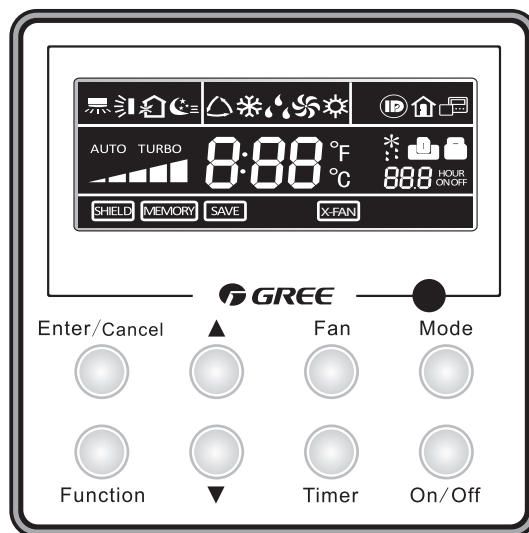

OPERATING INSTRUCTIONS

ON/OFF BUTTON

Press On/Off to turn On the unit. Press again to turn it Off.

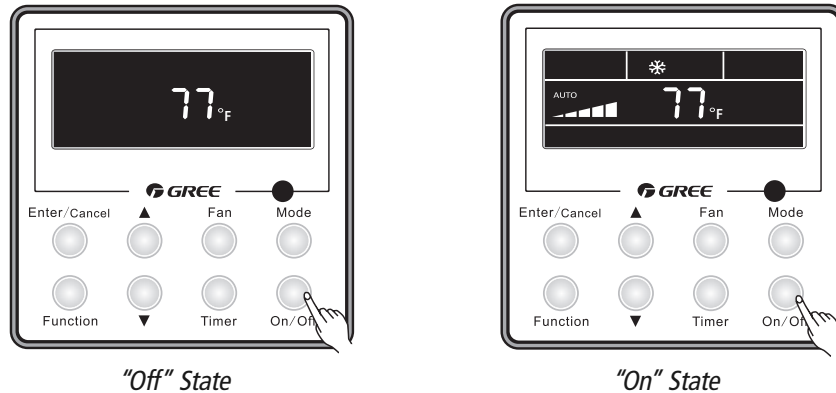

MODE SETTING

When the unit is ON, press Mode button to select an operating mode. It will change sequentially as shown below: Auto–Cool–Dry–Fan–Heat

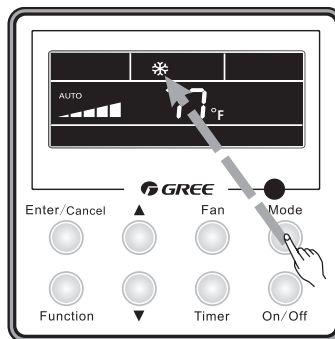
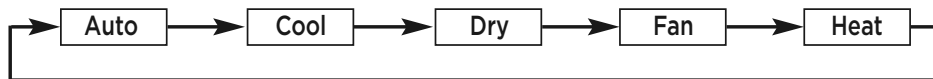

TEMPERATURE SETTING

Press ▲ or ▼ to increase/decrease the setpoint temperature as shown below. In Cool, Dry, Fan or Heat mode, the setpoint temperature range is 61°-86°F. In Auto mode, the setpoint temperature is not adjustable.

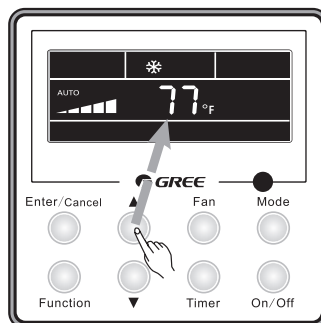

OPERATING INSTRUCTIONS

FAN SETTING

When the unit is ON, press Fan button to select the fan speed of the indoor unit. It will change sequentially as shown below.

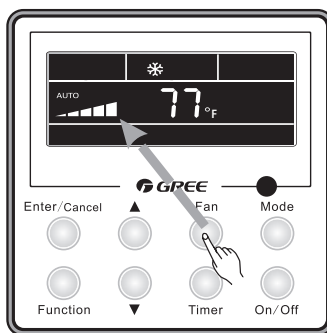
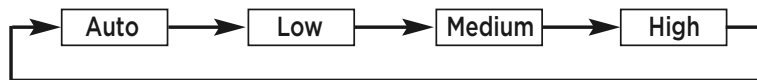

TURBO MODE

Turbo mode will force the unit up to maximum capacity to heat or cool the room in the shortest amount of time. Turbo Mode can only be used on Heat or Cool modes.

Turbo Setting

Press Function button until the Turbo icon is displayed. Then press Enter/Cancel to confirm. To cancel, press the Function button to re-enter the Turbo setting status, then press Enter/Cancel.

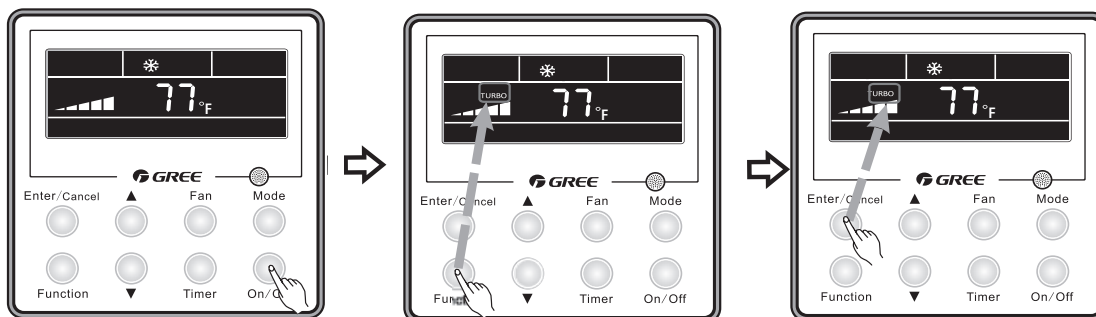

Turn On the unit and select Heat or Cool mode. Press Function until Turbo mode Icon is displayed. Press Enter/Cancel to start Turbo mode.

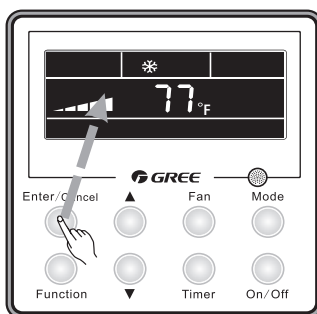

Cancel Turbo Mode

To cancel, press Function button to re-enter the Turbo settings, then press Enter/Cancel button.



OPERATING INSTRUCTIONS

TIMER SETTING

The U-Match System has two timer modes. The Timer-On mode will turn the unit ON after the preset time period. The Timer-Off Mode will turn the unit OFF after the preset time period. The preset time period can be from 0.5 to 24 hours in 0.5 hour increments.

Timer-On Setting

Turn the unit Off, press the Timer button. The OFF icon will flash and the hours will be displayed. Set the time period for the unit to remain OFF before turning ON by pressing the ▲ or ▼ buttons. Press Timer button to confirm and start Timer-On mode.

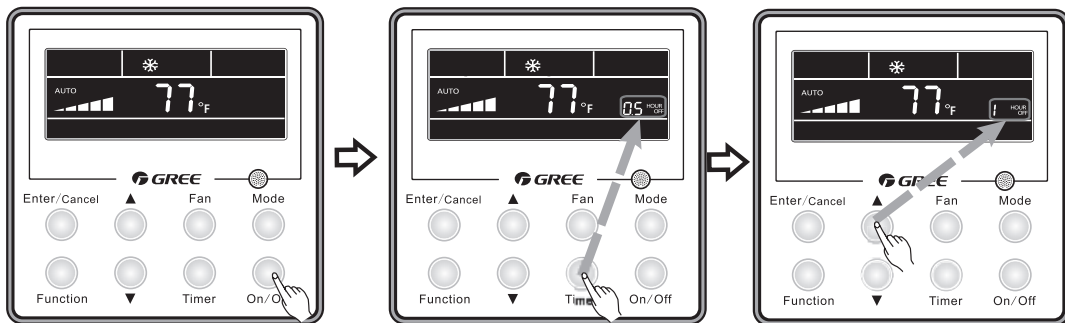

Turn Off the unit.

Press Timer button to select Timer On mode.

Press ▲ or ▼ to select time period.

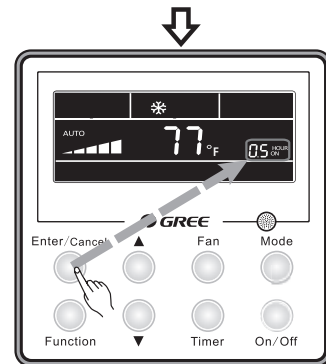

Press Enter/Cancel to start timer mode.

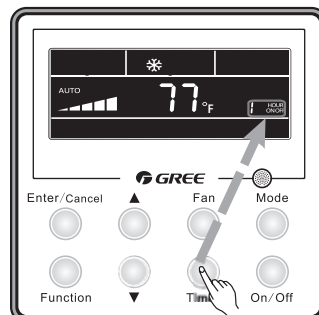

Cancel Timer

Timer modes can be cancelled anytime by pressing the Timer button.

OPERATING INSTRUCTIONS

Timer-Off Setting

Turn the unit On, press the Timer button. The ON icon will flash and the hours will be displayed. Set the time period for the unit to remain ON before turning OFF by pressing the ▲ or ▼ buttons. Press Timer button to confirm and start Timer-Off mode.

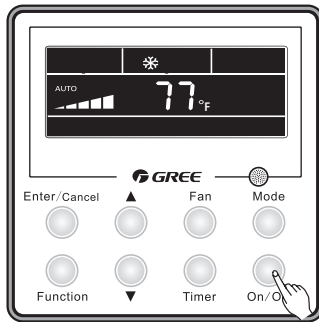

Turn On the unit and select Heat or Cool mode.

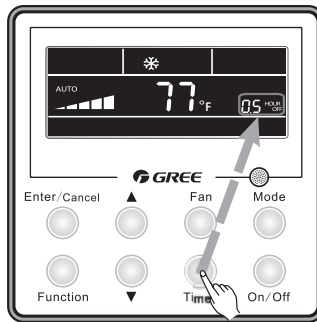

Press Timer button to select Timer Off mode.

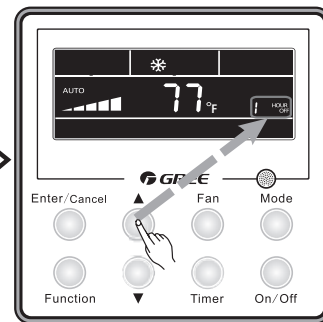

Press ▲ or ▼ to select time period.

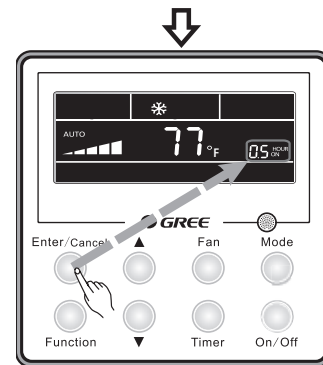

Press Enter/Cancel to start timer mode.

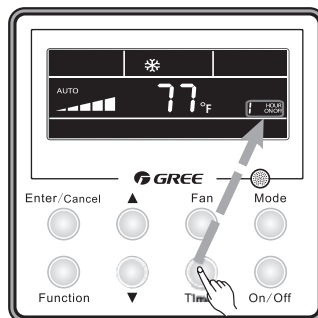

Cancel Timer

Timer modes can be cancelled anytime by pressing the Timer button.

OPERATING INSTRUCTIONS

SLEEP MODE

The unit will automatically adjust room temperature during your sleep time. This slight change in temperature will not affect your comfort level due to the natural effects that sleeping has on the body, but it will save on energy consumption and will lower your electric bill. Press the SLEEP button to select Sleep Mode. The SLEEP  icon will appear.

In Cool or Dry modes:

If setpoint is between 61°F to 73°F, temperature will slowly increase 2°F per hour for 3 hours, then maintain this setpoint for 4 hours, then reduce setpoint by 2°F and hold at this setpoint until Sleep Mode is cancelled.

If setpoint is between 74°F to 81°F, temperature will slowly increase 2°F per hour for 2 hours, then maintain this setpoint for 5 hours, then reduce setpoint by 2°F and hold at this setpoint until Sleep Mode is cancelled.

If setpoint is between 82°F to 85°F, temperature will slowly increase 2°F per hour for 1 hour, then maintain this setpoint for 6 hours, then reduce setpoint by 2°F and hold at this setpoint until Sleep Mode is cancelled.

If setpoint is 86°F, unit will run at this setpoint for 7 hours, then reduce setpoint by 2°F and hold at this setpoint until Sleep Mode is cancelled.

In Heat mode:

If setpoint is between 82 °F to 86°F, the unit will slowly reduce setpoint by 2°F per hour for 3 hours, and then maintain this setpoint until Sleep Mode is cancelled.

If setpoint is between 69 °F to 81°F, the unit will slowly reduce setpoint by 2°F per hour for 2 hours, and then maintain this setpoint until Sleep Mode is cancelled.

If setpoint is between 63°F to 68°F, the unit will reduce setpoint by 2°F, and then maintain this setpoint until Sleep Mode is cancelled.

If setpoint is 62°F, the unit will run at this setpoint until Sleep Mode is cancelled.

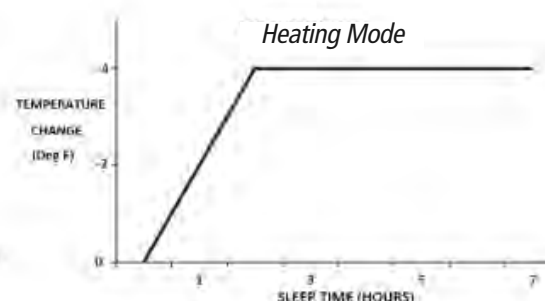
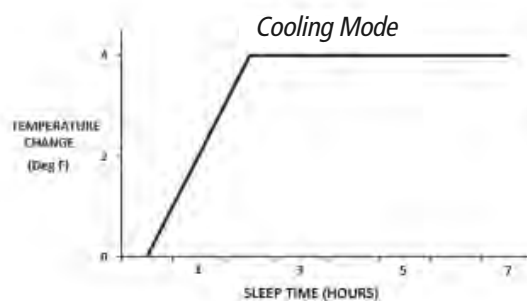

OPERATING INSTRUCTIONS

Sleep Setting

Turn the unit On and select a mode (ex. Heat, Cool, or Dry). Press the Function button until the Sleep icon appears on the display. Press the Enter/Cancel button to start Sleep Mode.

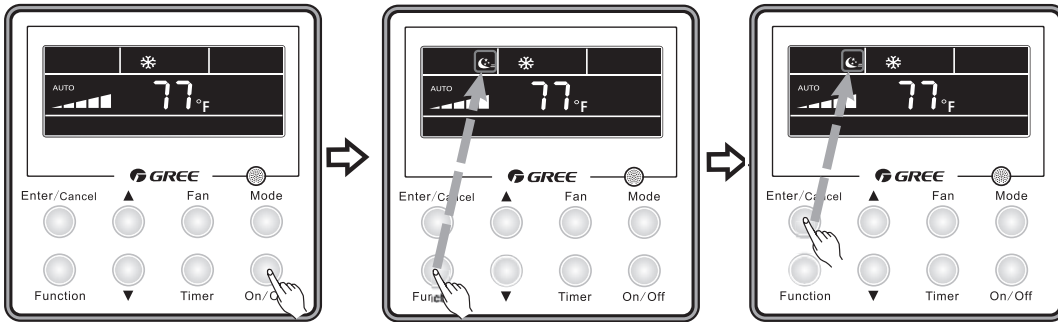

Turn On the unit and select a mode.

Press Function until the Sleep icon is displayed.

Press Enter/Cancel to start Sleep Mode.

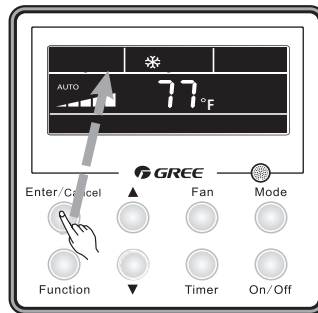

Cancel Sleep Mode

Press Function until the Sleep icon appears.
Press the Enter/Cancel button to cancel Sleep Mode.

OPERATING INSTRUCTIONS

X-FAN MODE

The X-Fan function may only be selected in Cool and Dry modes. After the unit is turned Off, the X-Fan function will keep the indoor fan running for 2 minutes to dry the indoor evaporator coil to help avoid mold and mildew growth.

X-Fan Settings

Turn the unit On and select Cool or Dry mode. Press Function button until X-fan icon is displayed and then press Enter/Cancel to activate this function.

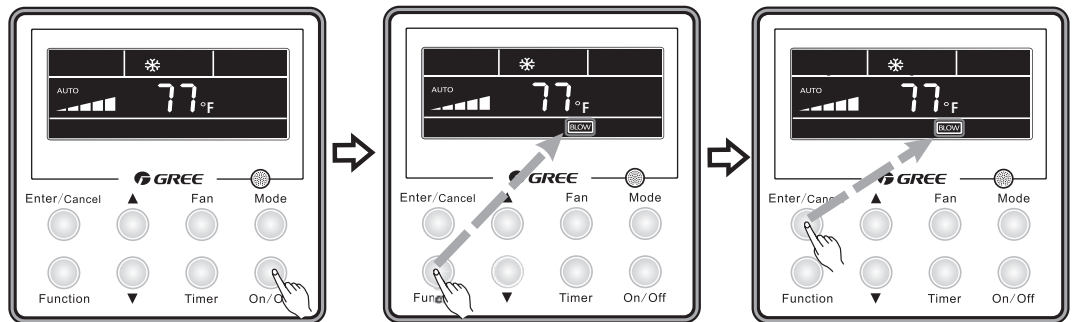

Turn On the unit, select Cooling or Dry mode.

Press Function until the X-fan icon is displayed.

Press Enter/Cancel to start X-fan mode.

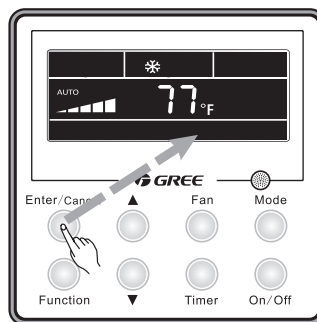

Cancel X-Fan Mode

To cancel, press Function button to re-enter the X-Fan settings, then press Enter/Cancel button.

OPERATING INSTRUCTIONS

I-FEEL MODE

The indoor unit will sense room temperature at the wired Tether Controller instead of at the return air section of the indoor unit.

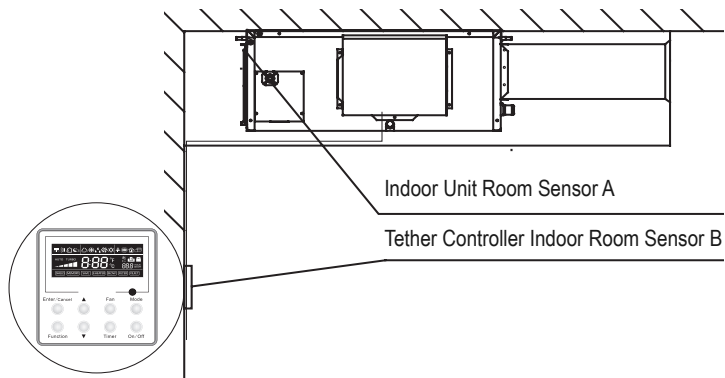

I-Feel Settings

Press the Function button until the I-Feel icon is displayed, then press Enter/Cancel to activate the function.

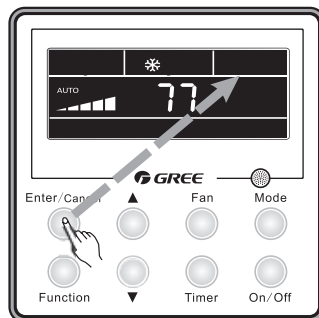
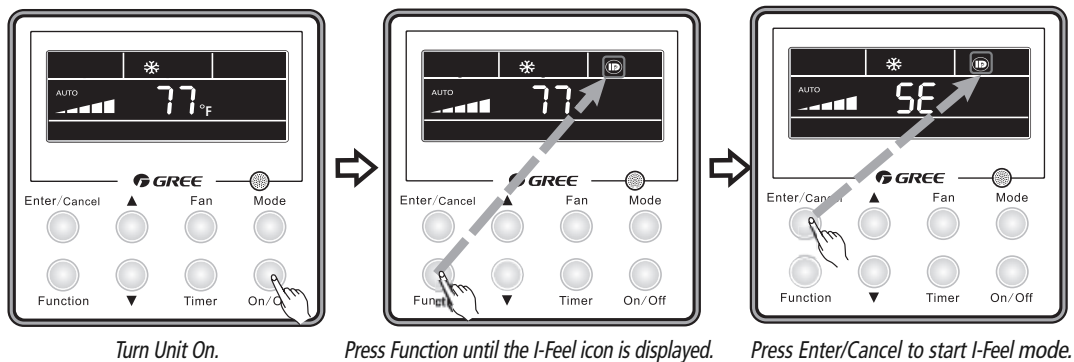

Cancel I-Feel Mode

To cancel, press Function button to re-enter the I-Feel settings, then press Enter/Cancel button.

OPERATING INSTRUCTIONS

FREEZE GUARD MODE

The unit will automatically maintain the room temperature above 46° F. This setpoint temperature is not adjustable. Freeze Guard Mode can only be selected with the unit in Heat Mode. Fan speed selection will be not be allowed; the unit will automatically select the proper fan speed for the room conditions.

Freeze Guard Setting

In Heat mode, press Function until the Freeze Guard icon is displayed. Press Enter/Cancel button to activate.

To deactivate, press Function to select "Freeze Guard" setting status. Then press Enter/Cancel until the flashing "Freeze Guard" symbol disappears.

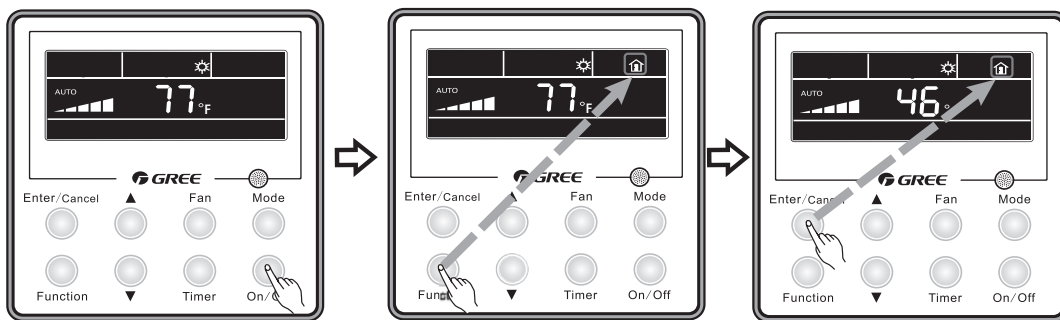

Turn Unit On and select Heat Mode.

Press Function until the Freeze Guard icon is displayed.

Press Enter/Cancel to start Freeze Guard mode.

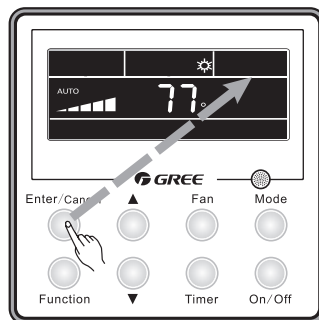

Cancel Freeze Guard Mode

To cancel, press Function button to re-enter the Freeze Guard settings, then press Enter/Cancel button.

OPERATING INSTRUCTIONS

Setup and Configuration Modes

INDOOR FAN MODE

The unit has two selectable indoor fan operating modes:

Mode 0 (Factory default setting): The indoor fan will run continuously, except in heat mode, where the indoor fan will continue to run for 60 seconds after room temperature reaches setpoint.

Mode 1: The indoor fan will turn Off 10 seconds after the room temperature reaches setpoint, regardless of the mode.

Indoor Fan Mode Setting

Turn the unit Off, Press the Function and Timer buttons simultaneously for 5 seconds until 00 is displayed on the temperature display. Press Mode button until 05 is displayed. Then press ▲ and ▼ buttons to select the desired indoor fan mode ('00' for Mode 0 or '01' for Mode 1). Press Enter/Cancel button to activate.

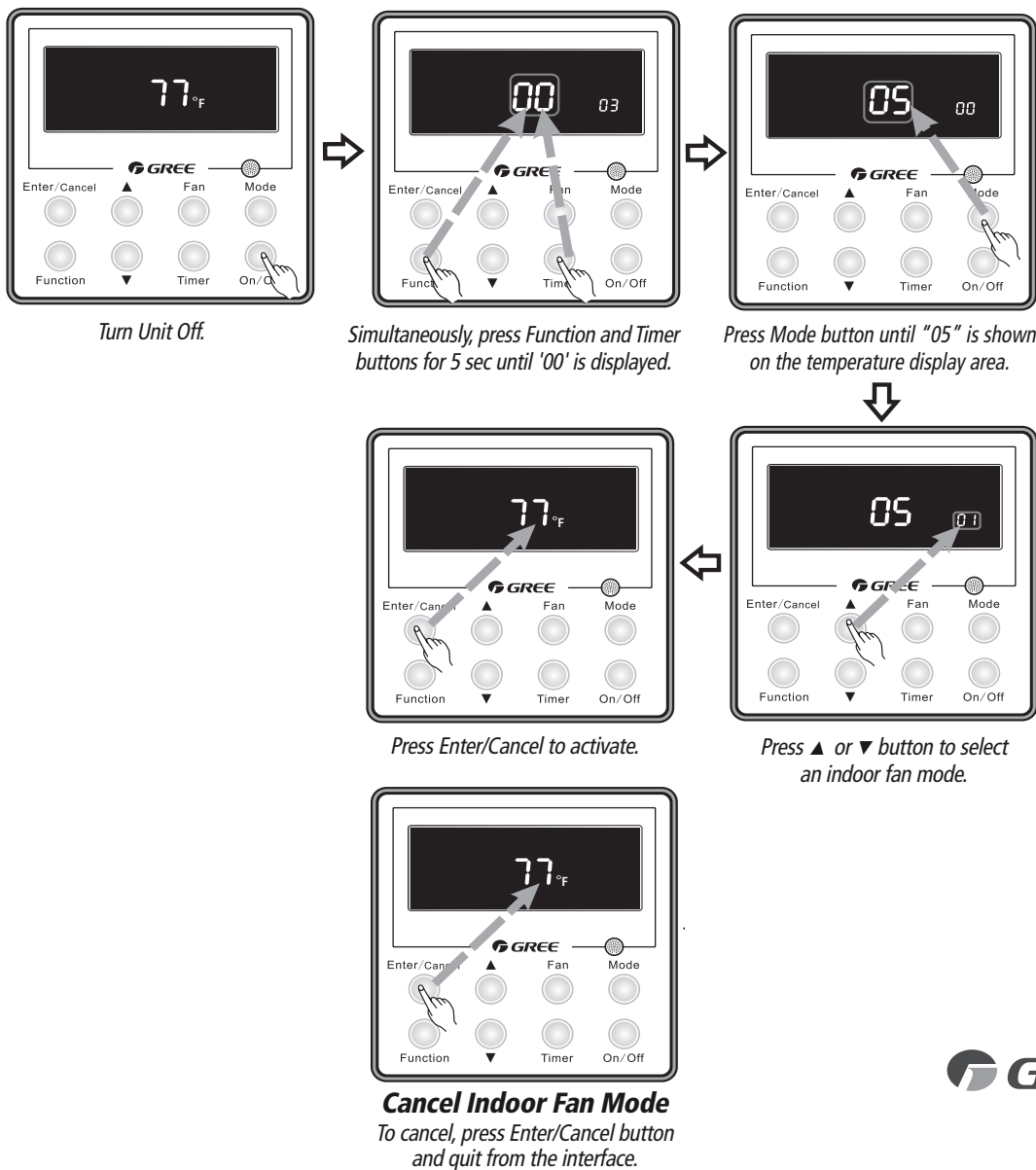

OPERATING INSTRUCTIONS

OUTDOOR AIR MODE

The Outdoor Air Mode can be used when a field supplied outdoor air damper is connected to the Slim Duct unit or ductwork. The Outdoor Air Mode controls the outdoor air entering the system.

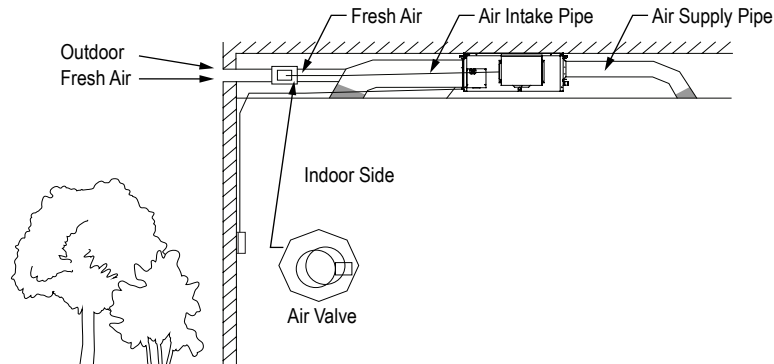

Outdoor Air Setting

When the unit is ON, press Function until the AIR icon is displayed. Press ▲ and ▼ to select the outdoor air damper run time (see table below).

Damper Run Time Table (Minutes)

AIR CODE	1	2	3	4	5	6	7	8	9	10
Air Damper Run Time	6-ON 54-OFF	12-ON 48-OFF	18-ON 42-OFF	24-ON 36-OFF	30-ON 30-OFF	36-ON 24-OFF	42-ON 18-OFF	48-ON 12-OFF	54-ON 6-OFF	60-ON 0-OFF

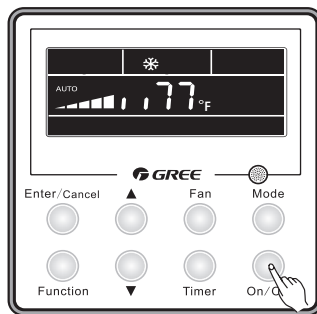

Turn Unit On.

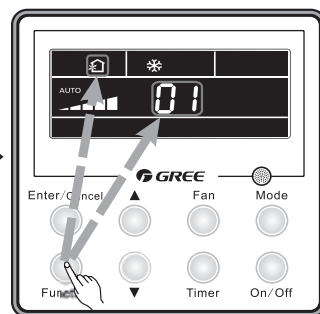

Press Function until the Air icon is displayed.

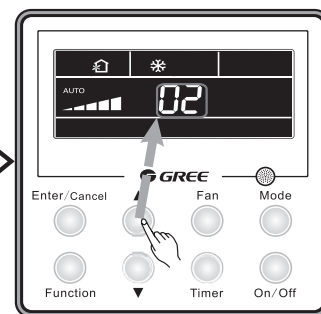

Press ▲ or ▼ button to select damper run time.

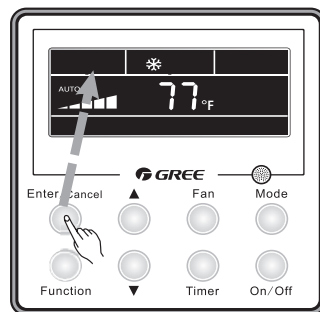

Cancel Outdoor Air Mode

To cancel, press Function button to re-enter the Outdoor Air Mode settings, then press Enter/Cancel button.

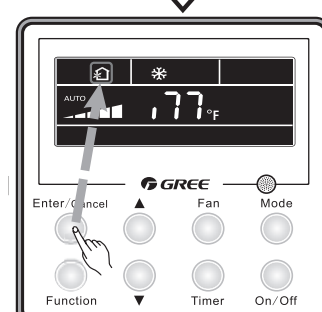

Press Enter/Cancel button to activate Outdoor Air Mode.

OPERATING INSTRUCTIONS

CELSIUS OR FAHRENHEIT TEMPERATURE DISPLAY

The wired Tether Controller is set from the factory to display temperature in Fahrenheit (F°). If Celsius (C°) is desired, turn the unit OFF, press Mode and ▼ buttons at the same time for 5 seconds to alternate between temperature displays.

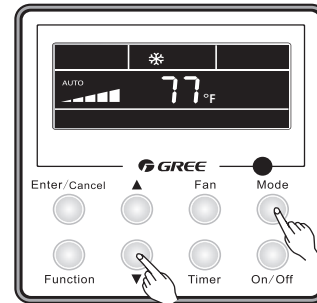

To change temperature display.

PRIVACY LOCK

The Privacy Lock prevents unauthorized access to the unit controls and prevents tampering with system settings. To lock the wired Tether Controller, press ▲ and ▼ buttons simultaneously for 5 seconds and the Lock Icon will be displayed.

Repeat the process to unlock the Tether Controller and cancel Privacy Lock.

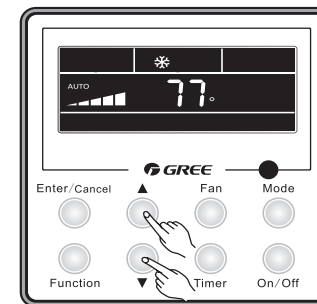

To activate Privacy Lock.

TEMPERATURE DISPLAY MODE

The wired Tether Controller may display either room temperature sensed at the system, room temperature sensed at the Tether Controller, or return air temperature sensed at the indoor unit.

Temperature Display Setting

To set the Tether Controller temperature display, turn unit Off. Press Function and Timer buttons simultaneously for 5 sec. The temperature display will show 00. Press the Mode button to select the Display Code (see table below) for the desired temperature display. Press Enter/Cancel button to save the setting.

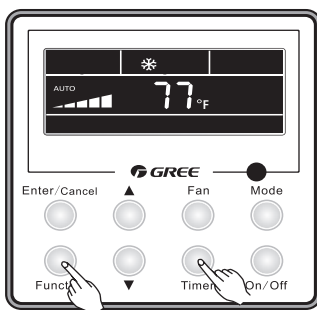

Press Function & Timer buttons simultaneously 5 sec until 00 is displayed.

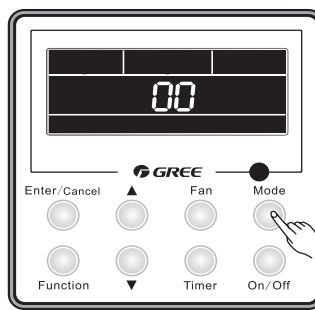

Press Mode button to select display mode.

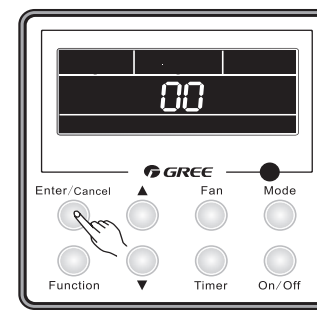

Press Enter/Cancel button to save setting.

DISPLAY CODE	TEMPERATURE DISPLAY MODE
01	Return air temperature sensed at the return air inlet.
02	Indoor ambient temperature sensed at the wired Tether Controller.
03 Factory Default Setting	Return air temperature sensed at the return air inlet during Cool, Dry and Fan modes. During Heat and Auto modes, display the indoor ambient temperature sensed at the wired Tether Controller.
04	Indoor ambient temperature sensed at the wired Tether Controller during Cool, Dry and Fan modes. Return air temperature sensed at the return air inlet during Heat & Auto modes.

OPERATING INSTRUCTIONS

POWER FAILURE MODES

The unit has two selectable system power up modes:

Power Failure Recovery

After the initial power up, the unit will store user selections and system parameters in non-volatile memory. These parameters are retained during a power failure. When power is returned, the system will automatically return to the last operating mode.

Power Failure Standby

The system will power up in standby or off mode. This is the factory default setting.

POWER FAILURE MODE SETTINGS

To set Power Failure Recovery Mode, turn the unit OFF and press the Mode and ▲ buttons simultaneously for 5 seconds until the MEMORY Icon is displayed.

Repeat the process to select Standby mode. In Standby mode the Memory icon is not displayed.

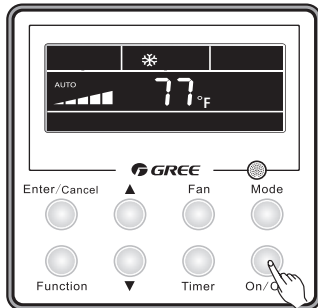

Turn Unit Off.

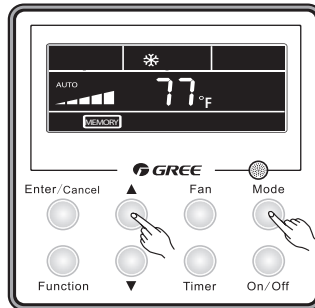

Press Mode and ▲ buttons 5 sec until MEMORY icon is displayed.

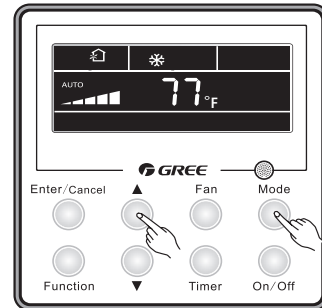

Repeat to change Modes.

CARE AND CLEANING

CLEANING THE FILTER

- *Never remove the air filter from the unit except for cleaning; otherwise it may cause dust or dirt to restrict airflow to the unit.*
- *When the air conditioning unit is used in an environment with heavy dust, the air filter should be cleaned often (generally once every two weeks).*

Perform the following on an annual basis:

- *Clean or replace air filter.*
- *Inspect drain line for potential clogs or leaks.*
- *Hose off both sides of the coil in the outdoor unit to remove loose debris or dirt buildup.*

CAUTION

Take notice of the following items before cleaning your air conditioning unit.

- *To avoid electric shock or injury, do not attempt to clean the unit unless it has been turned off and disconnected from the main power supply.*
- *Do not wash the unit with water; this may cause an electric shock.*
- *During cleaning, be sure to use a stable standing platform.*

TROUBLESHOOTING & DIAGNOSTIC CODES

Troubleshooting

PROBLEM	POSSIBLE CAUSES
Failed startup	<ul style="list-style-type: none"> • There is no power supply • Circuit breaker is tripped due to electrical leakage
Unit runs, then stops	<ul style="list-style-type: none"> • Air inlet/outlet of the indoor/outdoor unit is clogged
Poor cooling effect	<ul style="list-style-type: none"> • Air filter screen is too dirty or clogged • There are too many heat sources in the room • A door or window is open • There are obstacles at the air inlet/outlet • Temperature is set too high
Poor heating effect	<ul style="list-style-type: none"> • Air filter screen is too dirty or clogged • A door or window is open • Temperature is set too low

NOTE: If the air conditioner still malfunctions after checking these possible causes, contact an authorized service technician.

Diagnostic Codes

EQUIPMENT FAULT	ERROR CODES	POSSIBLE CAUSES
Indoor Configuration Jumper	C5	Missing Configuration Jumper on Indoor Control Board
Indoor/Outdoor Mismatch	LP	Indoor and Outdoor Units Do Not Match (Model or Capacity)
High Current Protection	E5	Power Supply is not Stable and Voltage Range is too Large
Communication Error	E6	Mis-wired or Communication Failure
Indoor Air Temp. Thermistor	F1	Bad Connection, or Indoor Air Sensor Failure
Indoor Coil Temp. Thermistor	F2	Bad Connection, or Indoor Coil Sensor Failure
Outdoor Air Temp. Thermistor	F3	Bad Connection, or Outdoor Ambient Sensor Failure
Outdoor Coil Temp. Thermistor	F4	Bad Connection, or Outdoor Coil Sensor Failure
Compressor Discharge	F5	Bad Connection, or Discharge Sensor Failure
Compressor Overload Protection	H3	Low Refrigerant Charge, Blocked Capillary, or Compressor Motor Failure
IPM Module Protection	H5	IPM Module Temperature Too High, High Ambient, Low Voltage, or Bad Connections
Indoor Fan Malfunction	H6	Indoor Fan Stopped or Running too Slow
Compressor Synchronism	H7	High Pressure, Low Voltage, or Bad Connections
4-Way Valve Malfunction	U7	Bad Connection, Solenoid Failure, or Valve Malfunction
Defrost Mode	H1	No failure, system is defrosting indoor coil
High Pressure Protection	E1	Too much refrigerant, High Ambient conditions or low airflow

ENERGY SAVING TIPS

- 1. Relaxing room temperature at night is OK:** During the nighttime hours you don't require the same level of conscious cooling or heating. Try using Sleep Mode to gradually relax room temperature and allow the unit to run less and save energy.
- 2. Curtains and shades:** In the summer, you need to block the effects of the sun. Close window curtains and shades on the south and west side of your home to help block solar heat. In winter, the sun is your friend. Open curtains and shades to allow solar heat into your room.
- 3. Close doors:** If you don't need to heat and cool your whole home, confine the heating and cooling to one room by closing doors. Limit the space you're heating and cooling to specified capability of the unit.
- 4. Service the unit:** Some basic maintenance might be all you need. The outdoor unit will greatly benefit from a good hosing out, especially in treed areas where seeds and other debris can stick to coil fins and make the unit work up to 15% harder!
- 5. Rearrange the room:** Furniture that obstructs airflow means you could be heating and cooling the back of a chair or the front of a sofa instead of the actual living space. Remove or rearrange obstacles blocking airflow.
- 6. Try 75 degrees:** 75°F is a good point for an air conditioner to run at its optimal performance level. Even a 5-degree change in temperature can make your unit use up to 40% more energy!
- 7. Lighting:** Turning lights off can help reduce your heat. Each light bulb is a tiny heater. Your air conditioner must waste energy overcoming the heat from your lights to reach and hold your desired room temperature.
- 8. Is anyone home?** If possible, while you're away turn your unit to Auto mode and make sure windows and drapes are closed. Although room temperature may be less than optimal for a few minutes when you come home, the unit will soon have the room back to your desired temperature.
- 9. Don't forget the fan:** The fan is much like a car. The faster it runs, the more energy it uses. Sometimes we need the car to go fast, but slow is good enough most of the time. Try saving money by using the comfortable quiet low fan speed as much as possible.



GREE ELECTRIC APPLIANCES, INC.

www.greecomfort.com



LIMITED WARRANTY

GREE distributor (hereinafter "Company") warrants this product against failure due to defect in materials or workmanship under normal use and maintenance as follows. All warranty periods begin on the date of original installation. If the date cannot be verified, the warranty period begins one hundred twenty (120) days from date of manufacture. If a part fails due to defect during the applicable warranty period Company will provide a new or remanufactured part, at Company's option, to replace the failed defective part at no charge for the part. This limited warranty is subject to all provisions, conditions, limitations and exclusions listed below.

- Seven (7) years on compressor and Five (5) years on all parts to the original registered end-user.
- One (1) year warranty on remote controller unit.
- Proper installation – Limited warranty applies only to systems that are installed by a state certified or licensed HVAC contractor, under applicable local and state law in accordance with all applicable building codes and permits; GREE installation and operation instructions and good trade practices.
- Warranty applies only to products remaining in their original installation location.
- Defective parts must be returned to the distributor through a registered servicing dealer for credit.

LIMITATIONS OF WARRANTIES: ALL IMPLIED WARRANTIES AND/OR CONDITIONS (INCLUDING IMPLIED WARRANTIES OR CONDITIONS OF MERCHANTABILITY AND FITNESS FOR A PARTICULAR USE OR PURPOSE) ARE LIMITED TO THE DURATION OF THIS LIMITED WARRANTY; SOME STATES OR PROVINCES DO NOT ALLOW LIMITATIONS ON HOW LONG AN IMPLIED WARRANTY OR CONDITION LASTS, SO THE ABOVE MAY NOT APPLY TO YOU. THE EXPRESS WARRANTIES MADE IN THIS WARRANTY ARE EXCLUSIVE AND MAY NOT BE ALTERED, ENLARGED, OR CHANGED BY ANY DISTRIBUTOR, DEALER, OR OTHER PERSON, WHATSOEVER.

THIS WARRANTY DOES NOT COVER:

1. Labor or other costs incurred for diagnosing, repairing, removing, installing, shipping, servicing or handling of either defective parts, or replacement parts, or new units.
2. Normal maintenance as outlined in the installation and servicing instructions or Owner's Manual, including filter cleaning and/or replacement and lubrication.
3. Failure, damage or repairs due to faulty installation, misapplication, abuse, improper servicing, unauthorized alteration or improper operation.
4. Failure to start due to voltage conditions, blown fuses, open circuit breakers, or damages due to the inadequacy or interruption of electrical service.
5. Failure or damage due to floods, winds, fires, lightning, accidents, corrosive environments (rust, etc.) or other conditions beyond the control of the Company.
6. Parts not supplied or designated by Company, or damages resulting from their use.
7. Products installed outside USA and Canada.
8. Electricity or fuel costs, or increases in electricity or fuel costs from any reason whatsoever, including additional or unusual use of supplemental electric heat.
9. Any cost to replace, refill or dispose of refrigerant, including the cost of refrigerant.
10. Any special, indirect or consequential property or commercial damage of any nature whatsoever. Some states or provinces do not allow the exclusion of incidental or consequential damages, so the above limitation may not apply to you.

For additional warranty exclusions, visit www.GreeComfort.com.

This warranty gives you specific legal rights, and you may also have other rights which vary from state to state or province to province.

For warranty service or repair, contact your installing contractor. You may find the installer's name on the equipment or in your Owner's packet.

Complete product registration below and send back by e-mail at service@twclimate.com

PRODUCT REGISTRATION

Model No. _____

Serial No. _____ Date of Installation _____

Owner Name _____

Address of Installation _____

Installing Contractor _____

Address _____

Phone No. / E-mail _____

WSO021513-DLSWARR-HP-Rev 3-8-13

Gree Electric Appliances, Inc ©2018 Cat No: GREE_U-MATCH_OWNERS_SLIM DUCT_060818