

SHARP

AQUOS

LED BACKLIGHT TV

USER MANUAL



2T-C32GH3000X 2T-C43GH3000X

To obtain the best performance and safety, please read this manual carefully.
Please keep this manual for future reference.

Content

Content	2
Preparation.....	3
Warnings and Precautions.....	4
Terminal Connection.....	9
Remote Control.....	10
Smart Features.....	11
Basic Features.....	12-13
User Settings.....	14 -19
Initial Setup.....	14
Source Menu.....	15
TV Menu.....	15
Dashboard Menu.....	16
Main Menu.....	16
Media Player.....	20 - 21
Troubleshooting.....	22
Specifications.....	23 - 24
Licenses.....	25
End User License Agreement	26 - 29

Note:

1. The pictures in this manual are only for references.
2. Design and specifications are subject to change without notice.
3. In dry environment due to static electricity, the product may restart and return to the main OSD interface, USB player interface or the previous source mode. It is normal and please continue to operate the TV.

Preparation

Unpacking and Installation

Note: The pictures are only for reference.



1

Open the package.



2

Take out the TV.

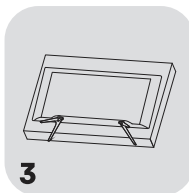

3

Install the TV stands.

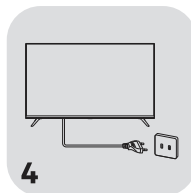

4

Connect the power cord.

Standard Accessories

Note: The pictures are only for reference.

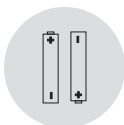

Batteries/2



Remote Control

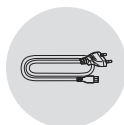

AC Power Cord

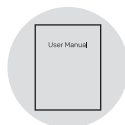

User Manual



For 2T-C32GH3000X,
Stand Base x2

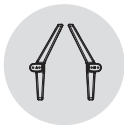

For 2T-C43GH3000X,
Stand Base x2



Stand Screws
2T-C32GH3000X : 2pcs
2T-C43GH3000X : 4pcs



VESA Spacers x8



For 2T-C32GH3000X
VESA Screws M4 x4

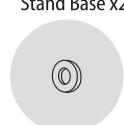

For 2T-C32GH3000X
Washer x 8



For 2T-C43GH3000X
VESA Screws M6 x4

Stand Installation

Note: The pictures are only for reference.

Step 1: Take out the TV and carefully put it (screen downward) on a stable and flat table with a soft cloth or cushion on it.

Step 2: Please check to make sure there is the same mark (A/B) on the TV back and the correct stand base. This step is not available for the bases without any mark on them, or not available for the TV with one stand base only.

Step 3: Fix the stand bases to the TV by fastening the matching stand screws provided in the box. The bases may vary depending on the region or model.

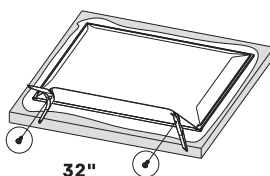
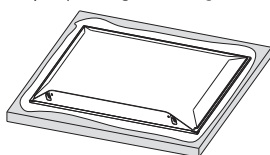

32"

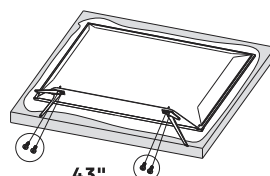

43"

Warnings and Precautions

Read all of the instructions before operating the set. Keep these instructions well for later use.

Important Safety Instructions

- Read these instructions – All the safety and operating instructions should be read before this product is operated.
 - Keep these instructions – The safety and operating instructions should be retained for future reference.
 - Heed all warnings – All warnings on the appliance and in the operating instructions should be adhered to.
 - Follow all instructions – All operating and use instructions should be followed.
 - Do not use this apparatus near water – The appliance should not be used near water or moisture – for example, in a wet basement or near a swimming pool, and the like.
 - Clean only with dry cloth.
 - Do not block any ventilation openings. Install in accordance with the manufacturer's instructions.
 - Do not install near any heat sources such as radiators, heat registers, stoves, or other apparatus (including amplifiers) that produce heat.
 - Do not defeat the safety purpose of the polarized or grounding plug. A polarized plug has two blades with one wider than the other. A grounding plug has two blades and a third grounding prong. The wide blade or the third prong is provided for your safety. If the provided plug does not fit into your outlet, consult an electrician for replacement of the obsolete outlet.
 - Protect the power cord from being walked on or pinched particularly at the plugs, convenience receptacles, and at the point where they exit from the apparatus. Only use attachments/accessories specified by the manufacturer.
 - Use only with the cart, stand, tripod, bracket, or table specified by the manufacturer, or sold with the apparatus. When a cart or rack is used, use caution when moving the cart/apparatus combination to avoid injury from tip-over.
 - Unplug the apparatus during lightning storms or when unused for long periods of time.
 - Refer all servicing to qualified personnel. Servicing is required when the apparatus has been damaged in any way, such as power supply cord or plug is damaged, liquid has been spilled or objects have fallen into the apparatus, the apparatus has been exposed to rain or moisture, does not operate normally, or has been dropped.
- CAUTION: These servicing instructions are for use by qualified service personnel only. To reduce the risk of electric shock, do not perform any servicing other than that contained in the operating instructions unless you are qualified to do so.
 - Do not install this equipment in a confined or building-in space such as a book case or similar unit, and remain a well ventilation conditions at open site. The ventilation should not be impeded by covering the ventilation openings with items such as newspaper, table-cloths, curtains etc.
 - Please refer the information on rear enclosure for electrical and safety information before installing or operating the apparatus.
 - To reduce the risk of fire or electric shock, do not expose this apparatus to rain or moisture.
 - The apparatus shall not be exposed to dripping or splashing and that no objects filled with liquids, such as vases, shall be placed on the apparatus.
 - For the terminals marked with symbol of “ $\frac{1}{4}$ ” may be of sufficient magnitude to constitute a risk of electric shock. The external wiring connected to the terminals requires installation by an instructed person or the used of ready-made leads or cords.
 - To prevent injury, use the stand/wall-mount bracket to securely install this apparatus on the table/wall in accordance with the installation instructions.
 - Danger of explosion if battery is incorrectly replaced. Replace only with the same or equivalent type.
 - The battery (battery or batteries or battery pack) shall not be exposed to excessive heat such as sunshine, fire or the like.
 - Excessive sound pressure from earphones and headphones can cause hearing loss. Listening to music at high volume levels and for extended durations can damage one's hearing. In order to reduce the risk of damage to hearing, one should lower the volume to a safe, comfortable level, and reduce the amount of time listening at high levels.
 - The appliance coupler is used as disconnect device, the disconnect device shall remain readily operable.
 - When not in use and during movement, please take care of the power cordset, e.g. tie up the power cordset with cable tie or something like that. It shall be free from sharp edges and the like that can cause abrasion of the power cordset. When put into use again, please make sure the power cordset being not damaged. If any damages found, please look for the service person to replace the power cordset.

Warnings and Precautions

● Attention should be drawn to environmental aspects of battery disposal.

● No naked flame sources, such as lighted candles, should be placed on the apparatus. To prevent the spread of fire, keep candles or other open flames away from the apparatus at all times.

● If the apparatus have the symbol  in its rating label and the power cord has two pins, it means that the equipment is a Class II or double insulated electrical appliance. It has been designed in such a way that it does not require a safety connection to electrical earth. (Only for Class II appliance)

● The following information are recommended to be included as far as applicable where applicable:

~ Refers to alternating current (AC).

--- Refers to direct current (DC).

 Refers to Class II equipment.

 Refers to stand-by.

I Refers to power ON.

 Refers to dangerous voltage.

● Warning for Apparatus containing COIN / BUTTON CELL BATTERIES (Below instruction only used for the apparatus containing a user-replaceable coin/button cell battery)

WARNING:

Do not ingest the battery, Chemical Burn Hazard (The remote control supplied with) this product contains a coin/button cell battery. If the coin/button cell battery is swallowed, it can cause severe Internal burns in just 2 hours and can lead to death. Keep new and used batteries away from children.

If the battery compartment does not close securely, stop using the product and keep it away from children. If you think batteries might have been swallowed or placed inside any part of the body, seek immediate medical attention.

● WEEE Directive



Correct Disposal of this product. This marking indicates that this product should not be disposed with other household wastes throughout the EU. To prevent possible harm to the environment or human health from uncontrolled waste disposal, recycle it responsibly to promote the sustainable reuse of material resources. To return your used device, please use the return and collection systems or contact the retailer where the product was purchased. They can take this product for environmental safe recycling.



● This lightning flash with arrowhead symbol within an equilateral triangle is intended

to alert the user to the presence of non-insulated "dangerous voltage" within the product's enclosure that may be of sufficient magnitude to constitute a risk of electric shock.

● To reduce the risk of electric shock. Do not remove cover (or back). No user serviceable parts inside. Refer to qualified service personnel.

● The exclamation point within an equilateral triangle is intended to alert the user to the presence of important operating and maintenance instructions in the literature accompanying the appliance.

Positioning the TV

● Install Display on solid horizontal surface such as a table or desk. For ventilation, leave a space of at least 10cm free all around the set. To prevent any fault and unsafe situations, please do not place any objects on top of the set.

Fixing the rear of enclosure to wall (only for some countries). The following picture is only for reference.

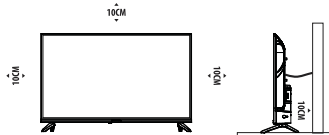

● Warning: Stability Hazard

A TV set may fall, causing serious personal injury or death. Many injuries, particularly to children, can be avoided by taking simple precautions such as:

- ALWAYS use cabinets or stands or mounting methods recommended by the manufacturer of the TV set.
- ALWAYS use furniture that can safely support the TV set.
- ALWAYS ensure the TV set is not overhanging the edge of the supporting furniture.
- ALWAYS educate children about the dangers of climbing on furniture to reach the TV set or its controls.
- ALWAYS route cords and cables connected to your TV so they cannot be tripped over, pulled or grabbed.
- NEVER place a TV set in an unstable location.
- NEVER place the TV set on tall furniture (for example, cupboards or bookcases) without anchoring both the furniture and the TV set to a suitable support.

Warnings and Precautions

- NEVER place the TV set on cloth or other materials that may be located between the TV set and supporting furniture.
- NEVER place items that might tempt children to climb, such as toys and remote controls, on the top of the TV or furniture on which the TV is placed.

If the existing TV set is being retained and relocated, the same considerations as above should be applied.

Mounting on a Wall

● An optional wall mount can be used with your TV. Consult with your local dealer to purchase the recommended wall mount bracket. Carefully attach the wall mount bracket at the rear of the TV. Install the wall mount bracket on a solid wall perpendicular to the floor. If you are attaching the TV to other building materials, please contact qualified personnel to install the wall mount. Detailed instructions will be included with the wall mount. Please use a wall mount bracket where the device is adequately secured to the wall with enough space to allow connectivity to external devices.

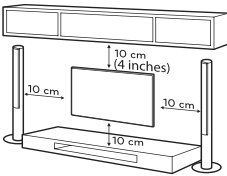

- To prevent product damages or personal injuries, please make sure that the TV screen is kept upright, or tilted upward or downward within the angle range of $0^{\circ}\sim 5^{\circ}$ while mounting the TV onto the wall.
- In case of exceeding the angle range ($0^{\circ}\sim 5^{\circ}$) of tilting downward, please purchase the auxiliary accessories from the local dealer to mount the TV for safe installation and usage. Otherwise, it will not be covered by the warranty and the user should be liable for all consequences and responsibilities.

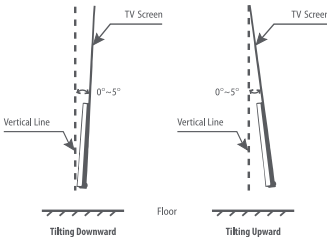

- Disconnect the power before moving or installing the TV. Otherwise electric shock may occur.
- Remove the stand before installing the TV on a wall mount by performing the stand attachment in reverse.
- If you install the TV on a ceiling or slanted wall, it may fall and result in severe injury. Use an authorized wall mount and contact the local dealer or qualified personnel. Otherwise it is not covered by the warranty.
- Do not over tighten the screws as this may cause damage to the TV and void your warranty.
- To prevent injury, this apparatus must be securely attached to the floor/wall in accordance with the installation instructions.
- Use the screws and wall mounts that meet the following specifications. Any damages or injuries by misuse or using an improper accessory are not covered by the warranty.
- It might be impossible to connect the cable to AV-IN depending on the form of VESA frame.

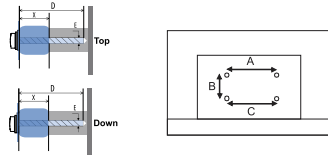

Model Size		32"		43"	
		Top	Down	Top	Down
Screw	Diameter(mm) "E"	M4	M4	M6	M6
	Depth(mm) "D"	Max	10+X	10+X	10+X
Min		7+X	7+X	7+X	7+X
Spacer	Depth(mm) "x"	20	20	30	30
Screw Quantity		2	2	2	2
Spacer Quantity		2	2	2	2
A*B*C		200*100*200		200*100*200	

Warnings and Precautions

● How to use VESA spacer for 32GH3000X

When using the included VESA Spacers; the included VESA Spacers has a "depth" of 10mm (X/2). So if you use them, please stack two VESA Spacers to make it 20mm (X).

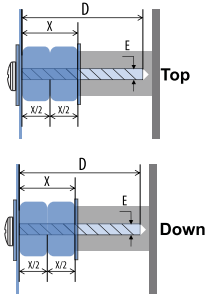

The included VESA screws are depth 30mm sample parts. Please purchase and use appropriate screws separately to match your wall mounting bracket.

Washer and VESA spacer installation image

● How to use VESA spacer for 43GH3000X

When using the included VESA Spacers; the included VESA Spacers has a "depth" of 15mm (X/2). So if you use them, please stack two VESA Spacers to make it 30mm (X).

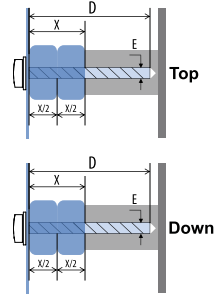

The included VESA screws are depth 40mm sample parts. Please purchase and use appropriate screws separately to match your wall mounting bracket.

Washer and VESA spacer installation image

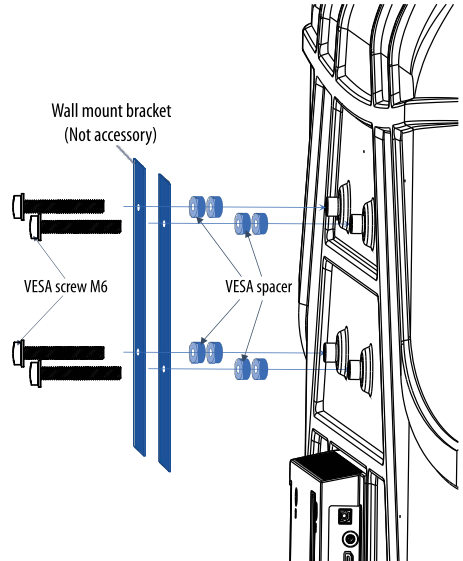
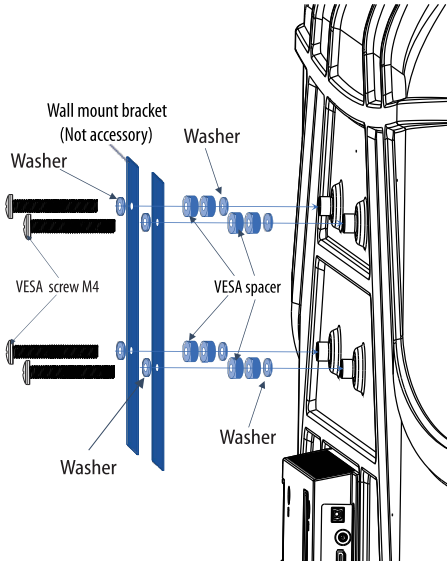

Warnings and Precautions

Note:

- 1) The pictures are for reference only.
- 2) For the TV sets with terminals facing towards the wall, in order to leave enough space to use the terminals, a rubber cushion is needed together with the screw to fix the wall mount. It is a small hollow pillar of which the height is $\geq 30\text{mm}$.

Operating Environment

- . Do not install this equipment in a confined space such as a bookcase or similar unit.
- . Do not use the set near damp, and cold areas, protect the set from overheating.
- . Keep away from direct sunlight.
- . Do not use the set near dust place.
- . Do not attach candle to accessible opening area, to avoid flammable foreign material from entering the TV.

Precautions for Using Remote Control

- . Use the remote control by pointing it towards the remote sensor. The items between the remote control and the remote sensor will interfere the normal operation.
- . Do not make remote control vibrate violently. Also, do not splash liquid on the remote control, also do not put the remote control in high humidity place.
- . Do not place remote control under direct sunlight which will cause deformation of the unit by heat.
- . When the remote sensor is under direct sunlight or strong lighting, the remote control will not work.
- . If so please change the lighting or TV's position, or operate the remote control closer to the remote sensor.

Precautions for Using Battery

Improper using of the battery will cause leakage. So please do as the following methods and use carefully.

1. Please note the batteries' polarity, to avoid short circuit.
2. When the battery's voltage is insufficient which affect the use range, you should replace new battery. Remove the batteries from the remote control unit if you do not intend to use it for a long time.
3. Do not use different types of batteries (for example, Manganese and Alkaline batteries) together.
4. Do not put the battery into fire, and charge or decompose the battery.
5. Please dispose batteries abide by relevant environmental protection regulation.
6. WARNING: The batteries (battery pack or batteries installed) shall not be exposed to excessive heat such as sunshine, fire or the like.

Install Remote Control Battery

Place two AAA size batteries in the remote controls battery compartment, making sure to match the polarity markings inside the compartment.

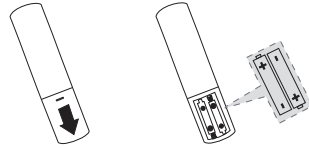

Note: The picture is only for reference.

TV Control Button

Note: The picture is only for reference.

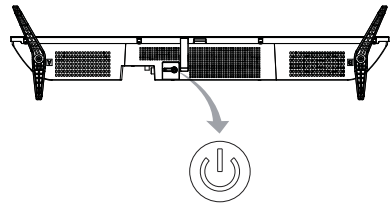

TV Control Button

- . Short press to display the menu.
(Power, Source, Volume $-$, Volume $+$, etc.)
- . Short press to select the menu.
- . Long press to confirm the selected menu.

Terminal Connection

Note:

- 1) The pictures are only for reference.
- 2) External equipments and cables shown herein are not supplied with the TV.
- 3) Terminal names and quantities may vary depending on the region or model.

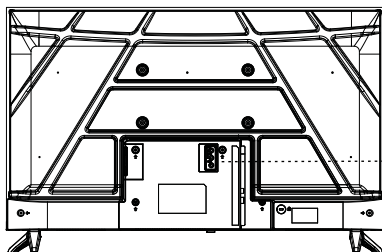

Red (AUDIO-R signal cable)
 White (AUDIO-L signal cable)
 Yellow (VIDEO signal cable)

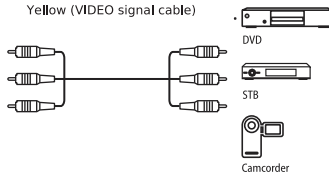

■ **AV IN**

Receive audio and video signal from external AV devices.

■ **DIGITAL AUDIO OUT**

Use an optical cable to output your TV audio signal to a compatible audio receiver.

■ **EARPHONE** (🎧)

Output the TV sound to the connected earphone. Speakers will be muted when headphone is plugged in.

■ **HDMI 1/2**

Receive HDMI input signal from external HDMI devices

Note:

When you need to connect a device which supports ARC function, select HDMI 2 interface

■ **ANTENNA IN**

Connect a coaxial cable to receive signal from the antenna, cable or satellite.

■ **LAN**

Wired network port.

■ **USB 1/2**

Connect a USB storage device.

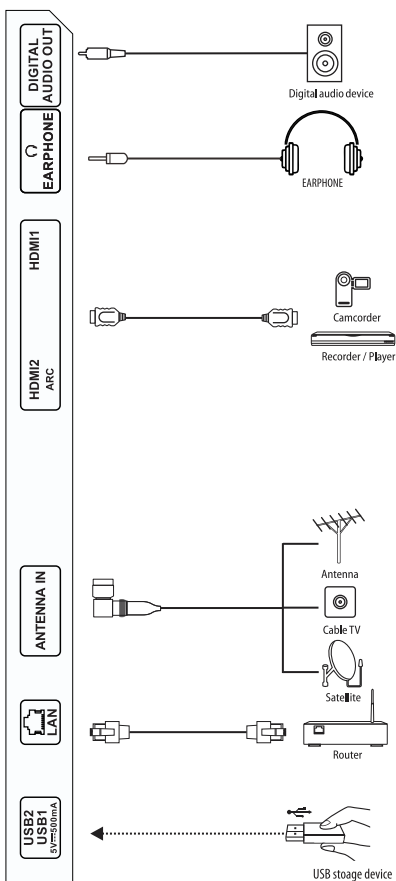

Remote Control

Note:

- 1). The picture is only for reference.
- 2). The image, buttons and functions of remote control may vary depending on the region or model.
- 3). The Bluetooth remote control can be paired with the TV easily and quickly by just pressing Google Assistant () button on any interface.

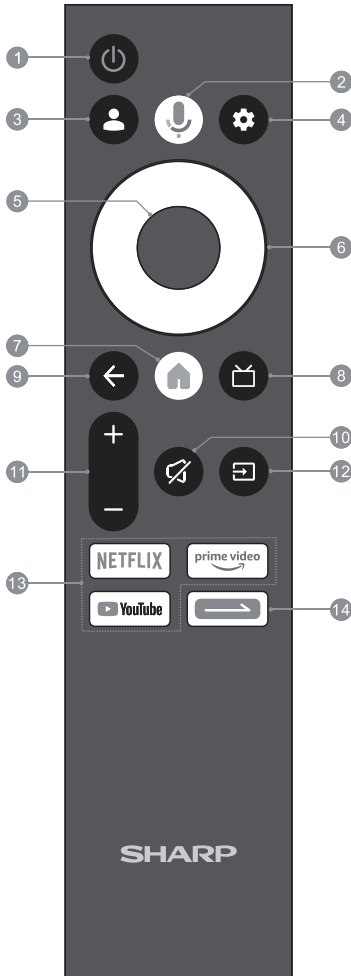

1. POWER ()

Turn on the TV, or turn the TV to fastboot / standby mode.

2. Google Assistant ()

Start using the near field voice function.

- Short press this button to wake up the Google Assistant.
- Long press this button to start receiving your voice command. After your speaking, release this button to run voice function.

3. Profile ()

Sign in with your Google account to get the entertainment you love.

4. Dashboard ()

Access the dashboard menu of your Google TV™.

5. OK

Confirm, enter or execute the selected item, or access the channel list.

6. Navigation Buttons (UP/DOWN/LEFT/RIGHT)

Navigate the menu to select the content you need, or

- Press UP/DOWN button to change channels.

7. HOME ()

Access the home screen.

8. EPG ()

Access DTV or access the Electronic Program Guide in DTV mode.

9. BACK ()

Return to upper-level content, or exit the current screen or operation.

10. MUTE ()

Mute or restore the TV sound.

11. Volume Up/Down (+/-)

Adjust the sound volume.

12. SOURCE ()

Access the source menu.

13. Application Buttons

Access specific applications quickly and directly.

14. Daily Key Button ()

This button works as shortcut key for quick access to your favorite apps and functions. To start using this button function, long press to open the setting and select your favorite apps or functions. After setting, short press to access the apps and functions.

Smart Features

Home Screen

Press **HOME** () button to access the home screen as shown in the following picture.

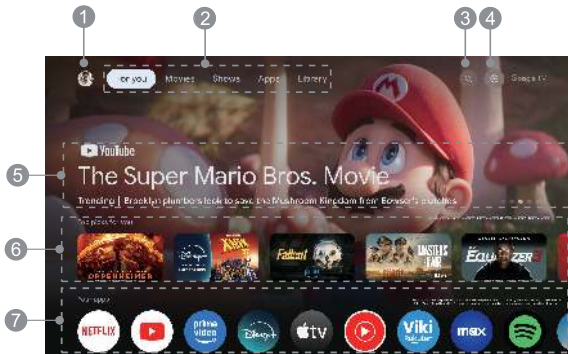

- 1. Account Center:** Add other family members' Google accounts, or setup and manage each Google account on your Google TV.
- 2. Navigation Bar:** Select to open tabs for various contents.
- 3. Search:** Search for movies, shows, apps and more.
- 4. Dashboard:** Access the dashboard menu of your Google TV.
- 5. Featured Carousel:** Display the hottest contents featured for you.
- 6. Top picks for you:** Highlight the best of recommendations from all content types.
- 7. Your apps:** Show the list of all pre-installed or user-installed applications on your Google TV.

Note:

- 1). The picture is only for reference.
- 2). Applications and contents on the home screen vary depending on the region or model. This manual doesn't include the operation instructions of all features on the home screen.
- 3). The browser may not support some web pages or videos due to network failure, difference of regions or service interruption, which has nothing to do with the TV.
- 4). If service providers upgrade or modify their servers, some applications may not be available on this TV.
- 5). Your remote control may not be compatible well with some network applications or fail due to service interruption, that has nothing to do with this TV.
- 6). For better experience, please connect and use the external mouse or keyboard when you access the internet browser or applications.
- 7). Some models support apk installation by the users, when using this feature, the users should ensure the correctness, security, compatibility and legality of the apk and should be responsible for any obligations thus resulted.
- 8). Some models support installing and using file manager application by the users, when using this feature, the users should not revise or delete a system file, otherwise will cause TV function problems and the customer should be responsible.
- 9). Network application contents and services are controlled by network application providers by means of networks and transmission facilities, which are subject to alteration, suspension, removal, termination or interruption, or invalid access at any time without further notice in that the manufacturer is unable to control or to be informed of the aforesaid change. The manufacturer makes a further declaration that it disclaims any responsibility or liability arising from customer's failure to use the network application contents and services caused by, including but not limited to, failure of network connection or communication lines, technological updates, or the alteration, suspension, interruption, termination, disabling, or removal of any contents or services by the network application providers etc.

Basic Features

Note: Colour buttons (**RED/GREEN/YELLOW/BLUE**) and play & pause buttons (▶ & ⏸) are listed in the virtual keyboard by pressing **SOURCE** (☰) button and selecting Virtual Keyboard from Shortcuts menu.

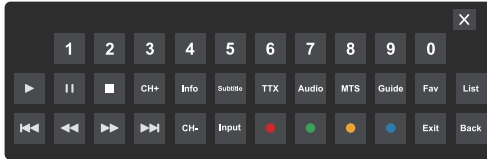

Note: The picture is only for reference.

Channel List

While watching programs in TV mode, press **OK** button to access the channel list.

1) In channel list:

- Press **RED** button in the virtual keyboard to manage channels.
- Press **GREEN** button in the virtual keyboard to operate channels.
- Press **YELLOW** button in the virtual keyboard to select another type of channel list, or access the favorite list.
- Press **BLUE** button in the virtual keyboard to add channels into the desired favorite list.

2) While playing favorite channels in the favorite list, you may only switch to play another favorite channel while pressing **UP/DOWN** button. If so, you can press **YELLOW** button in the virtual keyboard to select the type "All channels" when you want to watch all saved channels.

Electronic Program Guide





Note: The picture is only for reference.

Electronic Program Guide is supplied by the program providers and offers information about the programs to be broadcast. You can access it in DTV mode by pressing **EPG** (☰) button on the remote control.

- * Press **RED** button in the virtual keyboard to check the program information of previous day.
- * Press **GREEN** button in the virtual keyboard to check the program information of next day.
- * (May not be available) Press **YELLOW** button in the virtual keyboard to check more detailed information of the current program.
- * Press **BLUE** button in the virtual keyboard to select the desired program type.

Basic Features

Time-shift

Time-shift is used to record a DTV program when your viewing is interrupted or delayed. To enable or disable the Time-shift function, please select < **SOURCE** () button → Shortcuts → TV Menu → Record → Time Shift Mode > in DTV mode. After the Time-shift function has been enabled, press **Pause** () button in the virtual keyboard to pause playing the DTV program and start to record the program. Press **Play** () button in the virtual keyboard to continue playing the program from when you paused. Press **EXIT** button in the virtual keyboard to call out a prompt reminder, asking you whether or not to stop the time-shift function.

Note:

- 1) *Before time-shift, you'd better format your USB storage device to ensure there is enough space for time-shift recording. If you have any data saved on your USB storage device, please back up the data before formatting it. Formatting a USB storage device will erase all data saved on the USB storage device*
- 2) *The recorded program of time-shift will be cleared automatically after playing the program or stopping time-shift function.*
- 3) *If time-shift recording lasts too long, and there is no more space for recording new program, the TV will start to play the program automatically from the recording beginning to release the space of program which has been played for new program recording.*

User Settings

Initial Setup

When you turn on the TV for the first time, there will show a wizard to guide you to finish the following settings.

Step 1: Connect the Bluetooth® remote control.

Step 2: Select the menu language as you need.

Step 3: Select your region or country.

Step 4: Select to setup Google TV or setup basic TV. It is suggested that you select "Setup Google TV" to enjoy full smart features of your Google TV.

after setup google account

* TV will request automatic channel scan even if was done before. So, need to setup Google account before using TV functions.

*** For some countries, you can use your mobile phone or TV remote control to setup Google TV. If you prepare to setup the TV with your mobile phone, please operate according to on-screen instructions of both the TV and your phone. If you prepare to setup the TV with TV remote control, please select "Set up on TV instead"; and then go on with the following step. ***

Step 5: Connect your TV to the desired wireless network.

Step 6: Sign in with your Google account.

Step 7: Read to accept the Google terms of services and privacy policy.

Step 8: Read to accept the Google services settings.

Step 9: Learn the main feature of Google Assistant and select "Continue" to go to the next step.

Step 10: Select whether or not to let Google Assistant search across all your applications.

Step 11: Select to install the recommended applications from Google. This step may not be available depending on the Google service.

Step 12: Turn on or turn off the LCN (Logical Channel Number) switch.

Step 13: Setup the password for the parental lock system.

Step 14: Choose the TV usage environment between "Home" and "Shop". "Home" mode is recommended for normal home viewing, while "Shop" mode is used to demonstrate the TV in a shop and the like. It will consume more energy in "Shop" mode.

Step 15: Select the tuner mode.

Step 16: Start "Channel Scan".

Step 17: Read to accept the end user license agreement.

Step 18: Install your apps.

Step 19: Start exploring your Google TV.

Note:

1) Settings in initial setup may vary depending on the region or model.

2) Settings in initial setup may change without notice, which depends on Google requirements. You need to finish all settings according to what is indicated on the screen.

3) If you want to restart the initial setup after the first time, please select <DASHBOARD (⚙) button → Settings (⊕) → System → About → Reset>

User Settings

Source Menu

Press **SOURCE** () button to access the Source Menu as shown in the right picture.

- **Source:** Change the input source.
- **Shortcuts:** Setup to use each shortcut function.
- **Recent:** Show the list of recently-used applications.

Note:

- 1) The picture is only for reference.
- 2) Items in Source Menu may vary depending on the region, model or input source.



TV Menu

In TV mode, press **SOURCE** () button to access the source menu, then press **UP/DOWN/LEFT/RIGHT** and **OK** buttons to select and access the TV Menu as shown in the right pictures.

• Channels

Press **UP** button to select Channels menu.

- * **Programme Guide:** Access the electronic program guide in DTV mode.
- * **Channels:** Search for available TV channels.
- * **Channel Management:** Manage the channels.

• TV Options

- * **Source:** Open the source list.
- * **Picture:** Access the picture menu.
- * **Screen:** Select the screen mode.
- * **Sound:** Access the sound menu.
- * **Power:** Setup power options to turn off the TV or only the picture automatically.
- * **Parental Controls:** Setup for the parental lock system.
- * **CI Card:** Enable the user to select from the CAM-provided menu.
- * **Advanced Options:** Setup the advanced channel options.
- * **Settings:** Access main menu settings.

• Record

Press **DOWN** button to select Record menu.

- * **Device Info:** Show the detailed information of the connected USB storage device, and setup for the best usage of Time-shift function.
- * **Time Shift Mode:** Enable or disable the Time-shift function.

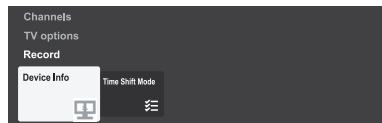
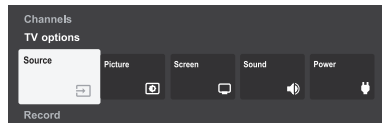
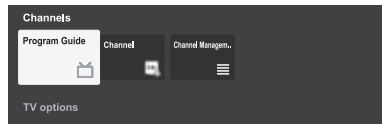

Note:

- 1) The pictures are only for reference.
- 2) Settings in TV Menu may vary depending on the region, model or input source.

User Settings

Dashboard Menu

Press **DASHBOARD** (⚙️) button to access the Dashboard Menu as shown in the right picture.

- 1. Date & Time:** Show the date and time.
- 2. Settings:** Access main menu settings.
- 3. Account Center:** Add other family members' Google accounts, or setup and manage each Google account on your Google TV.
- 4. Screensaver:** Open the screensaver mode.
- 5. Inputs:** Access the source list.
- 6. Picture:** Access the picture menu.
- 7. Sound:** Access the sound menu.
- 8. Wi-Fi:** Connect the TV to the network.
- 9. Accessibility:** Start the accessibility function to help the visually-impaired or hearing-impaired viewers understand and use the TV easily.
- 10. Notifications:** Show the detailed notifications or tips for the best usage of your Google TV.

Note:

- 1) The picture is only for reference.
- 2) Settings in Dashboard Menu may vary depending on the region, model or input source.

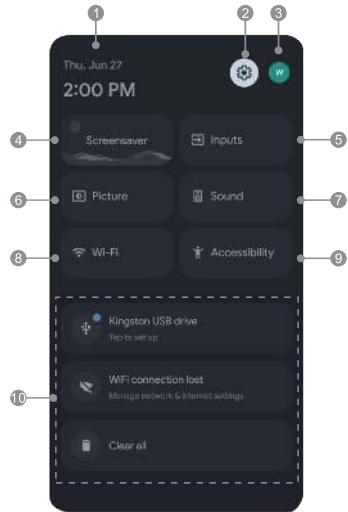

Main Menu

Step 1: In dashboard menu, select "Settings (⚙️)" to enter main menu settings as shown in the following pictures.

Step 2: Press **UP/DOWN** and **OK** buttons to select and enter a submenu.

Step 3: Press **UP/DOWN/LEFT/RIGHT** and **OK** buttons to select and adjust an item.

Step 4: Press **BACK** (←) button to back to the upper-level menu, or exit main menu settings.

Note:

- 1) The pictures are only for reference.
- 2) Settings in Main Menu may vary depending on the region, model or input source.

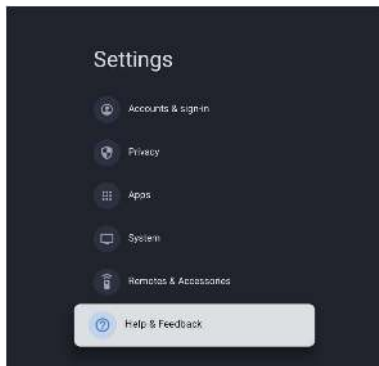
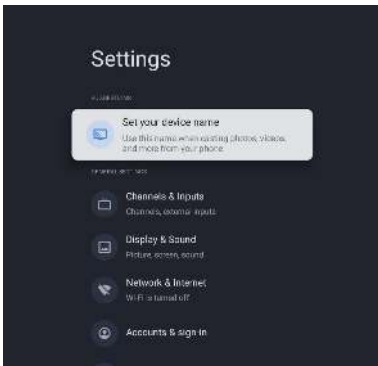

User Settings

SUGGESTIONS

Show the recommended or unfinished settings for the best usage of your Google TV.

GENERAL SETTINGS

Adjust settings related to your Google TV device and system.

Channels & Inputs

Search for available TV channels, or setup the input sources.

- **Channels:** Search for available TV channels.

*** Satellite Channel Tuning ***

To search for satellite channels in **Channels**, please refer to the following steps:

Step 1: Connect the satellite coaxial cable to the corresponding antenna port of the TV set.

Step 2: Turn on the TV and press **SOURCE** (☐) button to select "Satellite" as the input source in source list.

Step 3: Select < **DASHBOARD** (⚙) button → Settings (⊕) → Channels & Inputs → Channels → Satellite > to access the following interface of satellite tuning menu.

* **Channel Installation Mode:** Select the desired satellite channel installation mode between "Preferred Satellite" and "General Satellite".

* **Satellite Re-scan:** Search for satellite channels automatically.

* **Satellite Add:** Add a new satellite.

* **Satellite Update:** Search to update the satellite data.

* **Satellite Manual Tuning:** Search for satellite channels manually.

Note: Manual Tuning can be done only on the satellite used for automatic channels scan. If another satellite is selected inside manual tuning menu, please redo the automatic scan again from Channel menu then do manual tuning.

- **Inputs:** Setup the input sources.

- * Setup the standby or not-connected inputs.

- * Turn on or turn off the HDMI CEC link function to select whether or not to control the connected HDMI devices.

- * Select whether or not to turn off the connected HDMI devices when you turn off the TV.

- * Select whether or not to turn on the TV when you turn on the connected HDMI devices.

- * Show the HDMI EDID version.

- * Show the CEC device list.

Display & Sound

Adjust settings related to picture or sound quality.

- **Picture:** Adjust settings related to picture quality.

- * **Picture Mode:** Select the picture mode based on your viewing environment. Choices may vary depending on the input source.

- * **Backlight:** Adjust the backlight of the screen. It is available only when the "Auto Backlight" is turned off.

- * **Auto Backlight:** Turn on to automatically adjust the screen backlight depending on the input signal.

- * **Brightness:** Adjust the lightness of the picture.

- * **Contrast:** Adjust the difference between light and dark areas of the picture.

- * **Saturation:** Adjust the colorfulness of the color relative to its own brightness.

- * **HUE:** Adjust the color tint of the picture.

- * **Sharpness:** Adjust the edge of the picture.

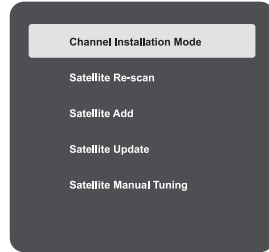

Note: The picture is only for reference.

User Settings

- * **Advanced Settings:** Adjust advanced picture settings. Choices may vary depending on the region, model or input source.
 - **Color Temperature:** Adjust the overall color tone of the picture.
 - **DNR:** Remove the noise from the picture signal.
 - **MPEG NR:** Reduce the noise created while compressing or converting the MPEG signal.
 - **Max Vivid:** Turn on or turn off the Max Vivid mode.
 - **Adaptive Luma Control:** Adjust the luma of the picture automatically depending on the input signal.
 - **Local Contrast Control:** Control local contrast.
 - **Dynamic Color Booster:** Select the effect of dynamic color booster.
 - **Flesh Tone:** Setup the flesh tone.
 - **DI Film mode:** Suppress the image jitter to achieve a stable and fluent play of the dynamic pictures.
 - **Blue Stretch:** Turn on or turn off the Blue Stretch function.
 - **Gamma:** Adjust the light intensity of original image.
 - **Game Mode:** It is automatically turned on when the picture mode is "Game".
 - **ALLM:** Turn on or turn off ALLM mode.
 - **PC Mode:** Turn on or turn off PC mode.
 - **HDMI RGB Range:** Setup the HDMI RGB range.
 - **Eye Protection Mode:** Select the effect of eye protection mode.
 - **Color Space:** Turn on or turn off color space.
 - **Color Tuner:** Adjust the detailed color parameters.
 - **11 Point White Balance Correction:** Adjust the detailed parameters of white balance correction.
- * **Reset to Default:** Restore all user settings in picture menu to the default values.

- **Screen:** Select the screen mode.

- **Sound:** Adjust settings related to sound quality.
 - * **Sound Style:** Select the sound mode based on your viewing requirements. Choices may vary depending on the input source.
 - * **Balance:** Control the sound balance between left and right speakers.
 - * **Bass:** Adjust the low frequency of the sound.
 - * **Treble:** Adjust the high frequency of the sound.
 - * **Sound Surround:** Turn on or turn off the surround sound system.
 - * **Equalizer Detail:** Adjust the equalizer frequencies in details. It is available only when you have selected "User" mode in "Sound Style".
 - * **Auto Volume Control:** Turn on to automatically adjust the sound volume depending on the input source.
 - * **Downmix Mode:** Select the downmix mode between "Stereo" and "Surround".
 - * **Dialogue Enhancer:** Select the effect of dialogue enhancer.
 - * **Reset to Default:** Restore all user settings in sound menu to the default values.

- **Audio Output:** Select the mode of digital audio output, or adjust the value of digital audio delay.

- **Network & Internet**
 - * Connect the TV to the wired or wireless network.
 - * Adjust settings related to the network configuration.
 - * Setup WOW/WOL/WOC function to turn on the TV from standby mode by your mobile device through network connection.

User Settings

■ Accounts & Sign In

- * Sign in to your Google account for new apps, recommendations, movies and more from Google.
- * Add other family members' Google accounts.
- * Setup and Manage each Google account on your Google TV.

■ Privacy

Adjust privacy-related settings including device settings, account settings and app settings.

■ Apps

- * Show the list of recently-opened, installed or system applications.
- * Setup app permissions to use specific functions.
- * Setup special app access to make the best usage of applications.
- * Setup restrictions on app installation from unknown sources.

■ System

- * Show basic device information.
- * Adjust settings related to the system and features of your Google TV.
- * Restart the TV, or restart the initial setup.

■ Remotes & Accessories

Connect the Bluetooth remote control or other Bluetooth devices. Before Bluetooth searching, please make sure that you have turned on the pairing mode of external Bluetooth devices. For the remote control supplied with the TV, please press and hold **BACK** (←) and **HOME** (🏠) buttons simultaneously to open its pairing mode. For other Bluetooth devices, please read their own instruction manual for opening the pairing mode.

Note: The Bluetooth remote control can be paired with the TV easily and quickly by just pressing Google Assistant (🗣️) button on any interface.

■ Help & Feedback

- * Send product feedback for Google's help.
- * Show the official website of Google TV Help.

Media Player

Media Operation

You can play video, audio and image files on the TV from your USB storage devices.

Step 1. Connect your USB storage device to the USB input terminal.

Step 2. Press **HOME** (🏠) button to enter the home screen.

Step 3. Press **UP/DOWN/LEFT/RIGHT** and **OK** buttons to select and enter "Multimedia Player" in the list of "Your apps".

Step 4. Press **UP/DOWN/LEFT/RIGHT** and **OK** buttons to select the desired USB storage device

Step 5. Press **UP/DOWN/LEFT/RIGHT** and **OK** buttons to select the desired media file.

Step 6. Press **OK** button to start the playback.

Step 7. Press **BACK** (←) button to exit the playback.

Gentle Reminder When Using the Media Player

- 1). Some USB storage devices may not be compatible to operate smoothly with this TV.
- 2). Back up all of the data in the USB storage device in case data was lost due to an unexpected accident. We do not assume any liability for the losses by misuse or malfunction. Data backup is consumer's responsibility.
- 3). For large file sizes, the loading time may be slightly longer.
- 4). The recognition speed of a USB storage device may depend on each device.
- 5). When connecting or disconnecting the USB storage device, ensure that the TV is not in USB mode otherwise the USB storage device or the files stored in it may be damaged.
- 6). Please use only a USB storage device which is formatted in FAT16, FAT32 or NTFS file system provided with the Windows operating system. In case of a storage device formatted as a different utility programme which is not supported by Windows, it may not be recognized.
- 7). When using a USB hard disk which requires electric power source, ensure its rated current does not exceed the current marked at the USB terminal. If the rated current of the USB hard Disk exceeds the marked current, the TV may be changed to standby mode or there may be some other problems, you should pull away the USB hard disk and restart the TV system.
- 8). An "Not support" message will be displayed if the file format is unsupported or corrupted.
- 9). FHD big picture needs longer time to process, which is not caused by the TV. Please be patient to wait.
- 10). This TV may not support some multimedia files changed and upgraded as the change of encoding format or other technical advances.

Media Player

Watch Movies

While watching a movie, press the following buttons to control the movie playback.

Button	Function
OK	Pause or play.
⚙️	Access the dashboard menu.
▲	Access movie menu settings.
▼	Show the movie playlist.
◀ or ▶	Fast backward or fast forward.

Play Music

While playing music, press the following buttons to control the music playback.

Button	Function
OK	Pause or play.
⚙️	Access the dashboard menu.
▲	Access music menu settings.
▼	Show the music playlist.
◀ or ▶	Short press to previous or next piece of music. Long press to fast backward or fast forward.

Browse Photos

While browsing a photo, press the following buttons to control the photo playback.

Button	Function
OK	Access photo menu settings.
⚙️	Access the dashboard menu.
▲ or ▼	Show the photo playlist.
◀ or ▶	Skip to previous or next photo.

Troubleshooting

Before calling a service technician, please check the following table for a possible cause of the symptom and some solutions.

■ General Problem / Solution

● Remote control does not work

- * Change the batteries.
- * Check if batteries are installed correctly.
- * Check if main power is connected.
- * Check if there are some items between remote sensor and remote control.

● Poor Signal

- * This is usually caused by interference from electronic equipments or radio interference sources.

■ Picture & Sound / Solution

● No picture, no sound

- * Check the signal source.
- * Plug another electrical device into the outlet to check if it is working or turned on.
- * Check if the power plug is in good contact with the outlet.

● No sound, picture OK

- * If no sound, unmute the sound or increase the sound volume.
- * Open the sound menu and adjust "Balance".

● Abnormal picture

- * For no color or bad picture quality, you may:
 1. Adjust the color option in picture menu settings.
 2. Keep the TV at a sufficient distance from other electronic devices.
 3. Try another channel.
- * Bad TV signal (Display mosaic or snowflakes)
 1. Check the signal cable and adjust the antenna.
 2. Fine tune the channel.
 3. Try another channel.

■ Multimedia Player / Solution

● "This file is invalid" / "Unsupported audio" appears, or audio is normal but video is abnormal, or video is normal but audio is abnormal.

- * The media file may be damaged, check if the file can be played on the PC.
- * Check if video and audio codec is supported.

■ Network / Solution (May not be available)

● Network failure

- * Check if the router works well.
- * Make sure the TV has been connected to the router successfully.

■ Browser / Solution (May not be available)

● Web page can not be displayed completely

- * Some third-party extensions of the current web page may not be supported, and please close the current web page.

● Browser is forced to be shut down

- * The current web page may include too many contents which cause there isn't sufficient memory and the browser is closed.

● Casting from smart phones:

- Check if TV and the smart phone are connected to the same wireless network.
- Check if Google casting application is used .
- Some smart phones may not work properly or be not supported.

Specifications

Note: Specifications may vary depending on the region or model.

Item	Model	2T-C32GH3000X	
LCD panel		80 cm	
Resolution		1,049,088 pixels (1366 x 768)	
Video colour system		PAL/SECAM/NTSC 3.58/NTSC 4.43/PAL 60	
TV function	TV-standard	Analogue	PAL: B/G, D/K, I SECAM: B/G, D/K, K/K1 NTSC: M
		Digital	DVB-T / DVB-T2 (for Asia only)
	Receiving channel	VHF/UHF	44.25 - 863.25 MHz
	TV-tuning system		Auto Preset
	STEREO/BILINGUAL		NICAM: B/G, I, D/K A2 stereo: B/G MTS:M
Audio amplifier		Total 16W (8W x 2)	
Terminals	ANTENNA IN	75Ω DIN type	
	HDMI 1	HDMI	
	HDMI 2	HDMI, ARC	
	USB1	USB 2.0 (DC5V 500mA output)	
	USB2	USB 2.0 (DC5V 500mA output)	
	LAN	Network connector (10/100 BASE-T)	
	EARPHONE	Earphone connector	
	DIGITAL AUDIO OUT	Optical S/PDIF digital audio output	
AV IN	Audio and video input		
Wi-Fi Protocol		IEEE 802.11 a/b/g/n/ac 2T/2R Dual Band	
Wi-Fi Security		WPA3-Personal, WPA2-Personal, WPA-Personal	
Bluetooth		V2.1 + EDR / 4.2 / 5.1	
OSD language		English/Afrikaans/Bosnian/Czech/Danish/German/Estonian/ Spanish/French/Croatia/Indonesian/Italian/Swahili/Latvian/ Lithuanian/Hungarian/Malaysian/Netherlands/Norwegian/Polish/ Portuguese/Romanian/Albanian/Slovak/Slovenian/Finnish/ Swedish/Vietnamese/Turkish/Greek/Serbian/Lithuanian/ Macedonian/Mongolian/Russian/Ukrainian/Georgian/Hebrew/ Arabic/Persian/Amharic/Hindi/Tamil/Thai/Burmese/Korean/ Simplified Chinese/Traditional Chinese/Japanese	
Power requirement		AC 100 - 240V, 50/60 Hz	
Power consumption (Standby)		60W (0.5W)	
Dimensions	without stand W x H x D (mm)	716 X 426 X 83	
	with stand W x H x D (mm)	716 x 466 x 178	
Weight without stand (with stand)		3.3 kg (3.4 kg)	
Operating temperature		0°C to + 40°C	

Specifications

Note: Specifications may vary depending on the region or model.

Item	Model	2T-C43GH3000X	
LCD panel		109 cm	
Resolution		2,073,600 pixels (1920 x 1080)	
Video colour system		PAL/SECAM/NTSC 3.58/NTSC 4.43/PAL 60	
TV function	TV-standard	Analogue	PAL: B/G, D/K, I SECAM: B/G, D/K, K/K1 NTSC: M
		Digital	DVB-T / DVB-T2 (for Asia only)
	Receiving channel	VHF/UHF	44.25 - 863.25 MHz
	TV-tuning system		Auto Preset
	STEREO/BILINGUAL		NICAM: B/G, I, D/K A2 stereo: B/G MTS:M
Audio amplifier		Total 16W (8W x 2)	
Terminals	ANTENNA IN	75Ω DIN type	
	HDMI 1	HDMI	
	HDMI 2	HDMI, ARC	
	USB1	USB 2.0 (DC5V 500mA output)	
	USB2	USB 2.0 (DC5V 500mA output)	
	LAN	Network connector (10/100 BASE-T)	
	EARPHONE	Earphone connector	
	DIGITAL AUDIO OUT	Optical S/PDIF digital audio output	
AV IN	Audio and video input		
Wi-Fi Protocol		IEEE 802.11 a/b/g/n/ac 2T/2R Dual Band	
Wi-Fi Security		WPA3-Personal, WPA2-Personal, WPA-Personal	
Bluetooth		V2.1 + EDR / 4.2 / 5.1	
OSD language		English/Afrikaans/Bosnian/Czech/Danish/German/Estonian/ Spanish/French/Croatia/Indonesian/Italian/Swahili/Latvian/ Lithuanian/Hungarian/Malaysian/Netherlands/Norwegian/Polish/ Portuguese/Romanian/Albanian/Slovak/Slovenian/Finnish/ Swedish/Vietnamese/Turkish/Greek/Serbian/Lithuanian/ Macedonian/Mongolian/Russian/Ukrainian/Georgian/Hebrew/ Arabic/Persian/Amharic/Hindi/Tamil/Thai/Burmese/Korean/ Simplified Chinese/Traditional Chinese/Japanese	
Power requirement		AC 100 - 240V, 50/60 Hz	
Power consumption (Standby)		74W (0.5W)	
Dimensions	without stand W x H x D (mm)	955 X 559 X 84	
	with stand W x H x D (mm)	955 x 603 x 212	
Weight without stand (with stand)		5.5 kg (5.6 kg)	
Operating temperature		0°C to + 40°C	

Licenses



Google TV is the name of this device's software experience and a trademark of Google LLC. Google, YouTube, Google Cast and YouTube Music are trademarks of Google LLC.



The terms HDMI, HDMI High-Definition Multimedia Interface, HDMI Trade dress and the HDMI Logos are trademarks or registered trademarks of HDMI Licensing Administrator, Inc.



Manufactured under license from Dolby Laboratories. Dolby, Dolby Audio, and the double-D symbol are trademarks of Dolby Laboratories Licensing Corporation.

End User License Agreement

1. General

Please read this agreement carefully before using this TV. Using this TV indicates your acceptance of this agreement. We reserve all rights not expressly granted to you in this End User License Agreement.

The End User License Agreement ("EULA") is a legal agreement between you (user of this TV) and us (the TV manufacturer) for the TV software, owned by us, third-party providers or third-party licensors. The TV software includes software for this TV, including updated or modified software, provided by us or third parties, whether stored on media or downloaded to this TV via any method, but not open source software.

2. Software License

You can't use the TV software except specified herein. We and third-party licensors grant you a limited license to use the TV software only on this TV. The TV software may create data files automatically and you agree that any such data files should be deemed as a part of the TV software. The TV software is licensed as a single product, and you should not separate its component parts for use on other devices unless expressly authorized by us. The software of a third party may be accompanied by a separate license, in which case you agree that such third-party license will govern your use of such third-party software.

You agree not to modify, reverse engineer, decompile or disassemble the TV software in whole or in part, or to use the TV software in whole or in part for any purpose other than allowed under this EULA. In addition, you should not TV software. You shall not (1) bypass, modify, defeat or circumvent any of the functions or protections of the TV software or any mechanisms operatively linked the TV software; or (2) remove, alter, cover or deface any trademark or notices on the TV software. We and third-party licensors retain all rights that this EULA does not expressly grant to you.

This TV contains open source software which is subject to open source licenses. Some GPL executables and LGPL / MPL libraries used in this TV are subject to the GPL2.0/LGPL2.1/MPL1.1 License Agreements. We hereby offer to deliver, upon request, a copy of the complete corresponding source code for the copyrighted open source software packages used in this TV for which such offer is requested by the respective licenses. This offer is valid for a period of three (3) years from the date the distribution of this TV by us. To obtain the source code, please contact our service center.

3. Software Updates or Modifications

We, or third parties may update or modify the software from time to time, for example, but not limited to, for the purposes of error correction, improvement of features and enhancement of security features. Such updates or modifications may change or delete the nature of features or other aspects of the TV software, including features you may rely on.

The updated or modified software will be provided to you by us or third parties through the network or other methods. And you may have the right to decide whether or not to accept or install such updates or modifications according to your actual need. Generally, as for updates or modifications provided by us, we recommend you to accept or install them for better use of this TV, and for some system-critical updates or modifications provided by us, which may decide whether or not this TV can be used normally and continuously, we may automatically download and install such updates or modifications in this TV without asking for your acceptance. As for updates or modifications provided by third parties, you decide completely at your own discretion, risk or liability. Please do not turn off this TV during software updating, otherwise it may cause serious problems for which you should be responsible by yourself.

4. Network - Based Services and Contents

This TV has the smart feature which provides access to selected application services (the services) from third - party providers. The smart feature requires a network connection. Your ability to access the services, and the quality of the services presented, are subject to your network provider 's service and terms as well as the network speed you use.

The contents, including but not limited to data, music, sound, audio, images, graphics, likenesses, software, text, video, messages, tags or other materials, provided by third-party providers, and the availability of the services are at the sole discretion and under the control of third-party providers. The contents and the services of each third - party provider are provided pursuant to the terms and conditions of that third - party provider.

The services and the contents are only used for your own personal, private viewing, and shall not be used for any viewing or exhibition for which (or in a venue in which) an access, or viewing fee is charged, or for any public

End User License Agreement

exhibition or viewing. The services and the contents are not available in all languages or in all countries or regions. Third parties make no representation that the services and the contents are appropriate or available for use in any particular location. To the extent you choose to use or access the services and the contents, you do at your own initiative and are responsible for compliance with any applicable laws, including but not limited to applicable local laws and privacy and data collection laws.

Some web pages or videos may not be supported due to network failure, difference of regions or service interruption, which has nothing to do with this TV. Some models may support apk installation by yourself, when using this feature, you should ensure the correctness, security, compatibility and legality of the apk and should be responsible for any obligations thus resulted in. Some models may support installing and using file manager application by yourself, when using this feature, you should not revise or delete a system file, otherwise it will cause function failure or data loss of this TV, and you should be responsible for any obligations thus resulted in obligations thus resulted in.

The services and the contents are controlled by third - party providers by means of network and transmission facilities, which are subject to alteration, suspension, removal, termination or interruption, or invalid access at any time without further notice in that the manufacturer is unable to control or to be informed of the aforesaid change. We make a further declaration that we disclaim any responsibility or liability arising from customer's failure to use the network application services and contents caused by, including but not limited to, failure of network connection or communication lines, technological updates, or the alteration, suspension, interruption, termination, disabling, or removal of any services or contents by the network application providers etc.

5. Content Rights

We are not responsible for the contents you may access as a part or via your use of the services that were created by or are owned by a third party. Any responsibility or liability for the contents shall remain solely with the creator, owner or licensor of such third - party content, and not with us.

You understand, acknowledge and agree that the contents are protected by the proprietary and intellectual property rights of the creator, owner or licensor of such third - party content. You must not modify, reverse - engineer, copy, rent, lease, loan, sell, resell, re-transmit, distribute, trade, publicly display or create derivative works of any third-party content, either in whole or in part, without obtaining a license from the creator, owner or licensor.

The content creator, owner or licensor may use Microsoft PlayReady content access technology ("PlayReady") to protect their intellectual property, including copyrighted content. This TV uses PlayReady technology to access PlayReady-protected Content and/or WMDRM-protected Content ("WMDRM" means Microsoft Window Media digital rights management technology). If this TV fails to properly enforce restrictions on Content usage, the content creator, owner or licensor may require Microsoft Corporation ("Microsoft") to revoke this TV's ability to consume PlayReady-protected Content. Revocation should not affect unprotected Content or Content protected by other content access technologies. The content creator, owner or licensor may require you to upgrade PlayReady to access their Content. If you decline an upgrade, you will not be able to access content that requires the upgrade.

The content creator, owner or licensor may use Widevine DRM content access technology to protect their intellectual property, including copyrighted content. This TV uses Widevine DRM technology to access Widevine DRM-protected Content. If this TV fails to properly enforce restrictions on Content usage, the content creator, owner or licensor may require Widevine Technologies (a company) to revoke this TV's ability to consume Widevine DRM-protected Content. Revocation should not affect unprotected Content or Content protected by other content access technologies. The content creator, owner or licensor may require you to upgrade Widevine DRM to access their Content. If you decline an upgrade, you will not be able to access content that requires the upgrade.

6. Use by Minors

If you are a parent or guardian permitting a person under the legal age of majority ("Minor") to use the services or the contents, you agree to: (1) supervise the Minor's use of the services or the contents, including receipt and transmission of information and materials via the services, and the transactions made for digital goods, the services and the contents. (3) assume any liability resulting from the Minor's use of the services and the contents. (4) be bound by this EULA for the Minor's access and use of the services and the contents.

7. Privacy Policy

We don't collect or use any personal information by this TV. However, when you access the applications provided by third-party providers over which we have no control, third parties may collect or receive certain information

End User License Agreement

through the use of Cookies or other similar technologies. We are not responsible for the security or privacy of any information collected by third parties. You should exercise caution and review the privacy statements applicable to the third-party services you use.

For example, but not limited to, when you watch a video or access the services or contents provided by a third-party provider. That provider may collect or receive information about this TV (its IP address, device identifies, etc.), the requested transaction (your request to buy or rent the video), your use of the services and contents, and so on.

To allow you to access, browse or use the services and the contents, third parties may require you to establish a user account for which you must provide them with your true, accurate, current and complete information about yourself. You are responsible for maintaining the confidentiality of any or all of your passwords associated with any such account.

Third parties may charge fees for access to their contents or services, and in no event will you be charged for access to any portion or all of the contents and services unless the third-party provider obtains your prior agreement to pay such charges. If you don't consent to such charges, you may not have access to paid contents or services for which such charges apply.

When you use the TV software or access the services, third parties may collect data from, control, and/or monitor this TV, or other devices running or interacting with this TV. We are not responsible and liable for any activities between you and third parties.

8. Disclaimer of Warranty

THE TV SOFTWARE, THE SERVICES AND THE CONTENTS ARE PROVIDED TO YOU "AS IS" AND "AS AVAILABLE" AND WITHOUT WARRANTIES OF ANY KIND. WE, THIRD-PARTY PROVIDERS AND THIRD-PARTY LICENSORS DISCLAIM ALL WARRANTIES AND CONDITIONS, EXPRESS OR IMPLIED, INCLUDING BUT NOT LIMITED TO THE IMPLIED WARRANTIES OF NON-INFRINGEMENT, TITLE, MERCHANTABILITY, AND FITNESS FOR A PARTICULAR PURPOSE. WE, THIRD-PARTY PROVIDERS AND THIRD-PARTY LICENSORS DO NOT WARRANT THAT THE TV SOFTWARE, THE SERVICES OR THE CONTENTS WILL MEET YOUR REQUIREMENTS, OR THAT THE OPERATION OF THE TV SOFTWARE THE SERVICES OR THE CONTENTS WILL BE UNINTERRUPTED OR ERROR FREE. FURTHERMORE, WE, THIRD-PARTY PROVIDERS AND THIRD-PARTY LICENSORS DO NOT WARRANT OR MAKE ANY REPRESENTATIONS OR CONDITIONS REGARDING THE USE OR THE RESULTS OF THE USE OF THE TV SOFTWARE, THE SERVICES OR THE CONTENTS IN TERMS OF THEIR CORRECTNESS, ACCURACY, RELIABILITY OR OTHERWISE. NO ORAL OR WRITTEN INFORMATION OR ADVICE GIVEN BY US SHALL CREATE A WARRANTY OR CONDITION, OR IN ANY WAY CHANGE THIS DISCLAIMER OF WARRANTY AND CONDITION. SHOULD THE TV SOFTWARE, MEDIA ON WHICH THE TV SOFTWARE IS FURNISHED, THE SERVICES OR THE CONTENTS PROVE DEFECTIVE, YOU ASSUME THE ENTIRE COST OF ALL NECESSARY SERVING, REPAIR OR CORRECTION.

YOU UNDERSTAND, ACKNOWLEDGE, AND AGREE THAT THE SERVICES CONTENTS AND RELATED SOFTWARES ARE PROVIDED BY THIRD-PARTY PROVIDERS OVER WHICH WE HAVE NO CONTROL. THE SELECTION, PROVISION, QUALITY, PICTURE SIZE AND AVAILABILITY OF SUCH CONTENTS OR SOFTWARE ARE THE SOLE RESPONSIBILITY OF SUCH THIRD-PARTY PROVIDER OR OTHER THIRD-PARTY PROVIDERS. YOU AGREE TO COMPLY WITH ANY AND ALL TERMS AND CONDITIONS THAT THE THIRD-PARTY MAY SET FOR ITS SERVICES, CONTENTS AND SOFTWARE. YOU UNDERSTAND, ACKNOWLEDGE, AND AGREE THAT ANY CONTENTS OR SOFTWARE DOWNLOADED OR OTHERWISE OBTAINED THROUGH USE OF THE SERVICES IS DONE AT YOUR OWN DISCRETION AND RISK, AND YOU SHOULD BE SOLELY RESPONSIBLE FOR ANY CONSEQUENCES THAT RESULTS, INCLUDING ANY DAMAGE OR HARM CAUSED BY ANY VIRUS, SPYWARE, WORM OR MALWARE.

9. Limitation of Liability

TO THE EXTENT PERMITTED BY APPLICABLE LAW, WE SHALL NOT BE LIABLE TO YOU, WHETHER IN CONTRACT, TORT (INCLUDING NEGLIGENCE), OR ANY THEORY OF LIABILITY, AN WHETHER OR NOT THAT THE POSSIBILITY OF SUCH DAMAGES OR LOSSES HAS BEEN NOTIFIED TO US, FOR THE FOLLOWING CIRCUMSTANCES:

- (1). ANY INDIRECT, INCIDENTAL, SPECIAL, PUNITIVE OR CONSEQUENTIAL DAMAGES.
- (2). ANY LOSS OF INCOME, BUSINESS, ACTUAL OR ANTICIPATED PROFITS, OPPORTUNITY, GOODWILL, OR REPUTATION (WHETHER DIRECT OR INDIRECT).
- (3). ANY DAMAGE TO OR CORRUPTION OF DATA (WHETHER DIRECT OR INDIRECT).
- (4). ANY LOSS OR DAMAGE AS A RESULT OF:
 - (A) USE YOU MAKE OF THE SERVICES.
 - (B) ANY RELIANCE PLACED BY YOU ON THE COMPLETENESS, ACCURACY OR EXISTENCE OF ANY ADVERTISING.
 - (C) ANY RELATIONSHIP OR TRANSACTION BETWEEN YOU AND AN THIRD-PARTY PROVIDER OF ANY SERVICE OR

End User License Agreement

CONTENT, INCLUDING ADVERTISERS AND SPONSORS WHOSE ADVERTISING IS MADE AVAILABLE ON OR VIA THE SERVICES.

(D) ANY CHANGES TO THE SERVICES, OR ANY PERMANENT OR TEMPORARY CESSATION IN THE PROVISION OF THE SERVICES OR ANY PORTION THEREOF .

10. Dispute Resolution

If a dispute, controversy or difference arising in any way from this EULA or your use of the TV software is not amicably settled, it shall be subject to the non-exclusive jurisdiction of the courts of the jurisdiction where you are a resident. Notwithstanding the foregoing, we may apply for injunctive remedies (or an equivalent type of urgent legal relief) that we deem necessary or appropriate in any jurisdiction.

11. Applicable Law and Severability

This EULA is governed by the laws of the jurisdiction where you are a resident, without regard to its conflict of law provisions. If any provision of this EULA is held to be void, invalid, unenforceable or illegal, the other provisions shall remain in full force and effect.

12. Termination

This EULA is effective until terminated. Your rights under this EULA will terminate automatically or otherwise cease to be effective without notice from us if you fail to comply with any items of this EULA. Upon termination of this EULA, you shall cease all use of the TV software, and you will have no recourse against us, third-party licensors or third-party providers.

13. Entire Agreement and Governing Language

This EULA is the entire agreement between you and us relating to the TV software and supersedes all prior or contemporaneous oral or written communications, proposals and representations with respect to the TV software or any other subject matter covered by this EULA. Any translation of this EULA is provided only for your convenience or local requirements. The English version of this EULA shall govern in the event of contradiction or dispute between English and any non-English versions .

SHARP

SHARP CORPORATION

SHARP

AQUOS

LED 背光电视

用户手册



2T-C32GH3000X 2T-C43GH3000X

为获得最佳性能和安全性，请仔细阅读本手册。
请保存好本手册，以便将来参考。

目录

目录	2
准备	3
警告和注意事项	4
端子连接	9
遥控器	10
智能功能	11
基本功能	12-13
用户设置	14-19
初始设置	14
源菜单	15
TV Menu (电视菜单)	15
仪表板菜单	16
主菜单	16
媒体播放器	20-21
故障排除	22
规格	23-24
许可	25
终端用户许可协议	26-28

注意：

1. 本手册中的图片仅供参考。
2. 设计和规格如有变更，恕不另行通知。
3. 在干燥的静电环境中，产品可能会重启并返回到主 OSD 界面、USB 播放器界面或之前的源模式。这是正常的，请继续操作电视。

准备

开箱和安装

注意：图片仅供参考。

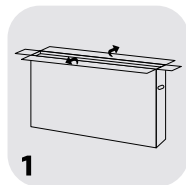

打开包装。

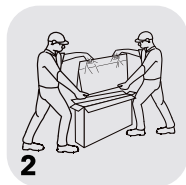

取出电视。

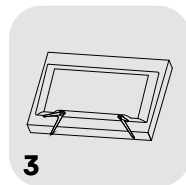

安装电视底座。

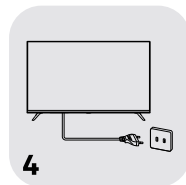

连接电源线。

标准配件

注意：图片仅供参考。

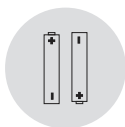

电池/2



遥控器

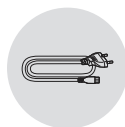

电源线

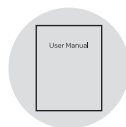

用户手册



对于
2T-C32GH3000X,
底座 x2

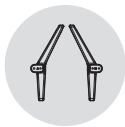

对于
2T-C43GH3000X,
底座 x2



底座螺钉
2T-C32GH3000X: 2pcs
2T-C43GH3000X: 4pcs



VESA垫圈 x8



对于
2T-C32GH3000X,
VESA螺钉 M4x4



对于
2T-C32GH3000X,
垫片 x8



对于
2T-C43GH3000X,
VESA 螺钉 M6x4

底座安装

注意：图片仅供参考。

第 1 步：取出电视，小心地将它（屏幕朝下）放在一个稳定平坦的桌子上，桌子上应已经放好一块软布或软垫。

第 2 步：请检查以确保电视背面的标记 (A/B) 与正确的支架底座上的标记相同。该步骤不适用于没有任何标记的底座，也不适用于只有一个支架底座的电视。

第 3 步：拧紧包装盒中提供的配套底座螺钉，将底座固定到电视上。底座可能因地区或型而异。

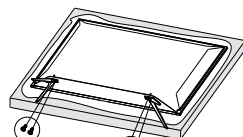
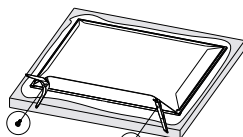
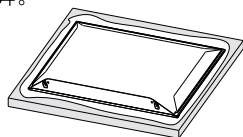

警告和注意事项

操作设备前，请阅读所有说明。
请妥善保存这些说明，以备今后使用。

重要安全说明

- 阅读这些说明 - 在操作本产品之前，应阅读所有安全和操作说明。
- 保存这些说明 - 安全和操作说明应保留，以备将来参考。
- 注意所有警告 - 应遵守设备上和操作说明中的所有警告。
- 遵循所有说明 - 应遵循所有操作和使用说明。
- 不得在靠近水的地方使用本设备 - 不得在靠近水或潮湿的地方使用本设备 - 例如，在潮湿的地下室或靠近游泳池等地方。
- 只能用干布清洁。
- 不得堵塞任何通风口。按照制造商的说明进行安装。
- 不得安装在任何热源附近，如散热器、热记录器、炉子或其他产生热量的设备（包括放大器）。
- 不得破坏极化或接地插头的安全用途。极化插头有两个叶片，其中一个比另一个宽。接地插头有两个叶片和一个接地尖头。为了您的安全，提供了宽叶片或上述接地尖头。如果提供的插头不适合您的插座，请咨询电工，更换过时的插座。
- 保护电源线不被踩踏或挤压，尤其是在插头、便利插座以及它们离开设备的位置。仅使用制造商指定的附件/配件。
- 仅使用制造商指定的或随设备出售的手推车、脚架、三脚架、支架或桌子。使用推车或支架时，移动推车/设备组合时要小心，以免翻倒受伤。
- 雷雨天气或长时间不使用时，请拔下设备插头。
- 请具备资质的人员进行所有维修工作。当设备以任何方式损坏时，如电源线或插头损坏、液体飞溅或物体落入设备、设备淋雨或受潮、无法正常工作或掉落，都需要进行维修。

- 注意：这些维修说明仅供具备资质的维修人员使用。为降低触电风险，除非您有资格进行维修，否则不要进行操作说明中未包含的任何维修。
- 不得将本设备安装在封闭或内置的空间，如书柜或类似装置中，并在开放场所保持良好的通风条件。不得用报纸、桌布、窗帘等物品盖住通风口，以免妨碍通风。
- 在安装或操作设备之前，请参考外壳上的电气和安全信息。
- 为了降低火灾或电击风险，请勿将设备暴露在雨水或湿气中。
- 仪器不应暴露在滴落或飞溅的环境中，也不应将装有液体的物体（如花瓶）放在设备上。
- 对于标有符号“⚡”的端子，其强度足以构成电击危险。连接到端子的外部接线需要由专业人员安装，或者使用现成的导线或电线。
- 为防止受伤，请根据安装说明，使用脚架/壁挂支架将本设备牢固地安装在桌子/墙壁上。
- 如果电池更换不当，会有爆炸危险。仅用相同或等效型号的电池替换。
- 电池（一个或多个电池或电池组）不得暴露在过热环境中，如阳光、火等。
- 耳机和头戴式耳机过大的声压会导致听力下降。长时间高音量听音乐会损害听力。为了降低听力受损的风险，人们应该将音量降低到安全、舒适的水平，并减少在高音量下听音乐的时间。
- 设备耦合器用作断开装置，断开装置应保持随时可操作状态。
- 不使用时和移动过程中，请保管好电源线，例如用扎带或类似的东西将电源线绑好。扎带不应带有可能导致电源线磨损的锐边等。再次投入使用时，请确保电源线没有损坏，如果发现任何损坏，请找维修人员更换电源线。

警告和注意事项

- 应注意电池处置的环境影响。
- 设备上不得放置明火源，如点燃的蜡烛。为防止火势蔓延，请始终将蜡烛或其他明火远离设备。
- 如果设备的额定值标签上有符号 ，并且电源线有两个插脚，则表示该设备为 II 类或双重绝缘电器。设备被设计为不需要安全电气接地。（仅适用于 II 类设备）
- 在适用的情况下，建议尽可能包括以下信息：

~ 是指交流电 (AC)。

— 是指直流电 (DC)。

 表示 II 类设备。

 表示待机。

 表示通电。

 表示危险电压。

- 包含硬币/纽扣电池的装置警告（以下说明仅用于包含用户可更换的硬币/纽扣电池的装置）

警告：

切勿吞咽电池，因为存在化学灼伤危险（遥控器随附）本产品包含一个硬币/纽扣电池。如果吞下硬币/纽扣电池，可能会在短短 2 小时内造成严重的内部烧伤，并可能导致死亡。将新电池和旧电池放在远离儿童的地方。

如果电池盒没有关紧，请停止使用本产品，并将其放在远离儿童的位置。如果您认为电池可能被吞入或放置在身体的任何部位内部，请立即就医。

- WEEE 指令

 本产品的正确处置。此标志表明，在整个欧盟，此产品不得与其他家庭垃圾一起处置。为了防止不受控制的废物处理对环境或人类健康造成可能的危害，应负责任地回收废物，以促进材料资源的可持续再利用。要退回您用过的设备，请使用退货和回收系统或联系向您出售产品的零售商。他们可以将您的产品用于环保安全回收。



- 在等边三角形中带有箭头符号的闪电旨在警告用户，产品外壳内存在未绝缘的“危险电压”，其强度可能足以构成电击危险。

●为降低触电风险。不得取下盖子（或背面）。内部没有用户可维修的部件。请咨询具备资格的维修人员。

●等边三角形中的感叹号旨在提醒用户在设备随附的资料中有重要的操作和维护说明。

安放电视

- 在坚固的水平面上（如桌子或书桌）上安装显示屏。为了通风，在设备周围留出至少 10 厘米的空间。为了防止任何故障和不安全的情况，请勿在设备顶部放置任何物体。

将外壳后部固定到墙上（仅适用于某些国家）。下图仅供参考。

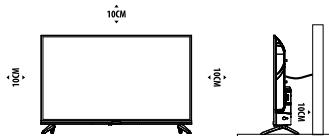

- 警告：稳定性危险
电视机可能会坠落，造成严重的人身伤害或死亡。许多伤害，特别是对儿童的伤害，可以通过采取简单的预防措施来避免，例如：
 - 始终使用电视机制造商推荐的机柜或支架或安装方法。
 - 始终使用能安全地支撑电视的家具。
 - 始终确保电视机没有悬在支撑家具的边缘。
 - 一定要教育孩子关于爬上家具去够电视或其控制装置的危险性。
 - 连接到电视上的电线和电缆始终要放好，这样它们就不会被绊到、拉到或抓到。
 - 千万不要把电视放在不稳定的位置。
 - 千万不要把电视放在高大的家具上（例如，橱柜或书柜）而同时又不将家具和电视固定在合适的支撑物上。

警告和注意事项

- 千万不要将电视放在布料或其他可能位于电视和配套家具之间的材料上。
- 千万不要在电视或摆放电视的家具上放置玩具、遥控器等可能会引诱孩子爬上去的物品。

如果要保留和重新安放现有电视机，应采用与上述提示相同的考虑因素。

安装在墙上

●可选的壁挂支架可用于安放您的电视。请咨询当地经销商，购买推荐的壁挂支架。小心地将壁挂支架安装在电视背面。将壁挂支架安装在垂直于地面的实心墙上。如果您要将电视安装在其他建筑材料上，请联系具备资质的人员来安装壁挂支架。壁挂支架中将包含详细说明。请使用壁挂支架，将设备充分固定在墙上，并留出足够的空间来连接外部设备。

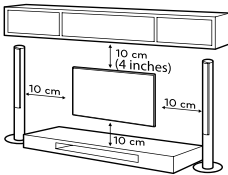

●为了防止产品损坏或人身伤害，请确保在将电视安装到墙上时，电视屏幕保持垂直，或在 $0 \sim 5^\circ$ 的角度范围内向上或向下倾斜。

●如果超过向下倾斜的角度范围 ($0^\circ \sim 5^\circ$)，为了安全安装和使用，请向当地经销商购买辅助配件来安装电视。否则电视将不在保修范围内，用户应承担一切后果和责任。

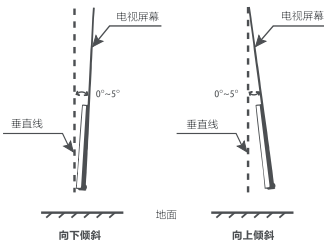

- 移动或安装电视前，请断开电源。否则可能会发生电击。
- 在将电视安装到壁挂上之前，执行安装支架的反向步骤，以取下支架。
- 如果您将电视安装在天花板或倾斜的墙壁上，它可能会掉落并导致严重伤害。使用授权的壁挂支架，并联系当地经销商或合格人员。否则不在保修范围内。
- 请勿过度拧紧螺钉，因为这可能会损坏电视并使您的保修失效。
- 为防止受伤，必须根据安装说明将设备牢固地固定在地面/墙壁上。
- 使用符合以下规格的螺钉和壁挂支架。因误用或使用不当配件而造成的任何损坏或伤害不在保修范围内。
- 根据 VESA 框架的形状，可能无法将线缆连接至 AV-IN。

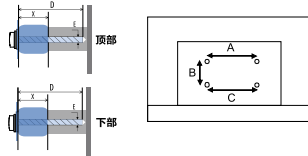

型号尺寸		32"		43"	
		顶部	下部	顶部	下部
螺钉	直径 (毫米) "E"	M4	M4	M6	M6
	深度 (毫米)	最大 10+X 最小 7+X	10+X 7+X	10+X 7+X	10+X 7+X
垫片	深度 (毫米) "X"	20	20	30	30
螺钉数量		2	2	2	2
垫片数量		2	2	2	2
A*B*C		200*100*200		200*100*200	

警告和注意事项

- 如何使用32GH3000X的壁挂垫圈
当使用附件袋内的壁挂垫片时;附件中的VESA垫圈的“深度”为10毫米($X/2$)。因此如果您使用它们,请堆叠两个VESA垫片,使其达到20毫米(X)。

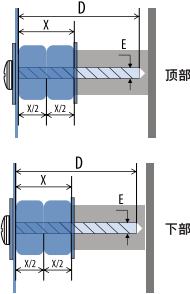

附件中的VESA螺钉是深度为30mm螺钉。请单独购买并使用合适的螺钉以匹配您的壁挂支架。

垫圈和VESA垫片安装图像

- 如何使用43GH3000X的壁挂垫圈
当使用附件袋内的壁挂垫片时;附件中的VESA垫圈的“深度”为15毫米($X/2$)。因此如果您使用它们,请堆叠两个VESA垫片,使其达到30毫米(X)。

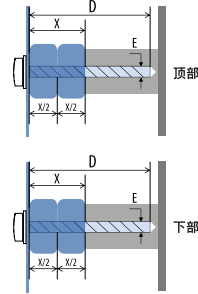

附件中的VESA螺钉是深度为40mm螺钉。请单独购买并使用合适的螺钉以匹配您的壁挂支架。

垫圈和VESA垫片安装图像

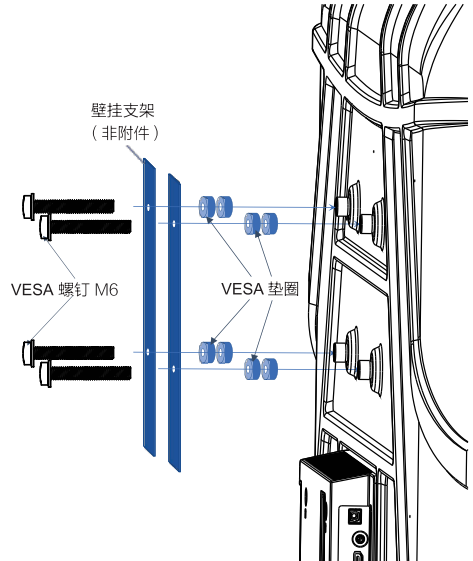
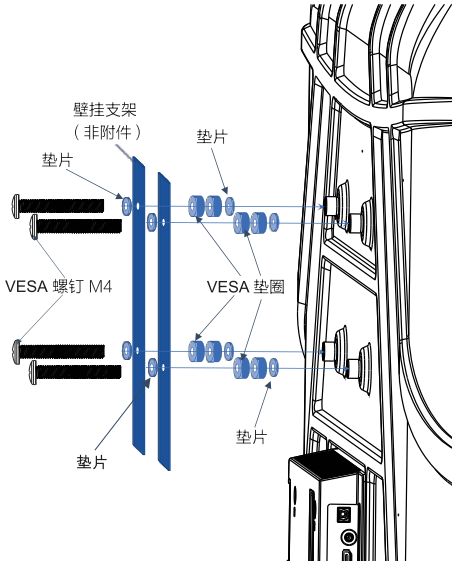

警告和注意事项

注意：

- 1) 图片仅供参考。
- 2) 对于端子朝向墙壁的电视机，为了留出足够的空间来使用端子，需要使用橡胶垫和螺钉来固定壁挂支架。它是一个高度 ≥ 30 毫米的空心小柱。

工作环境

- 请勿将本设备安装在狭窄的空间内，如书柜或类似装置。
- 请勿在潮湿和寒冷的地方使用本设备，并防止设备过热。
- 避免阳光直射。
- 请勿在有灰尘的地方使用本机。
- 请勿将蜡烛放在可触及的开口区域，以免易燃异物进入电视。

使用遥控器的注意事项

- 使用遥控器时，请将其指向遥控器。遥控器和遥控器之间的物品会干扰正常操作。
- 不得让遥控器剧烈振动。另外，不得将液体溅到遥控器上，也不得将遥控器放在高湿度的位置。
- 不得将遥控器放在阳光直射的位置，因为阳光直射会导致遥控器受热变形。
- 当遥控器受到阳光直射或强光照射时，遥控器将无法工作。如果是这样，请改变光线或电视的位置，或者在更靠近传感器的位置操作遥控器。

使用电池的注意事项

电池使用不当会导致漏电。因此，请按照以下方法操作并小心使用。

1. 请注意电池的极性，以避免短路。
2. 当电池电压不足，影响使用范围时，应更换新电池。如果您不想长时间使用遥控器，请取出电池。
3. 不得同时使用不同类型的电池（例如，锰电池和碱性电池）。
4. 不得将电池投入火中，也不得给电池充电或分解电池。
5. 请按照相关环保法规处置电池。
6. 警告：电池（电池组或已安装的电池）不得暴露在过热环境中，如阳光、火等。

安装遥控器电池

将两节 AAA 号电池放入遥控器电池盒中，确保电池盒内的极性标记一致。

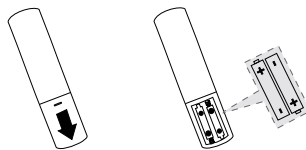

注意：图片仅供参考。

电视控制按钮

注意：图片仅供参考。

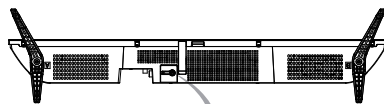

电视控制按钮

- 短按可显示菜单。（电源、来源、音量-，音量+ 等。）
- 短按以选择菜单。
- 长按可确认所选菜单。

端子连接

注意:

- 1) 图片仅供参考。
- 2) 此处显示的外部设备和电缆不随电视一起提供。
- 3) 端子名称和数量可能因地区或型号而异。

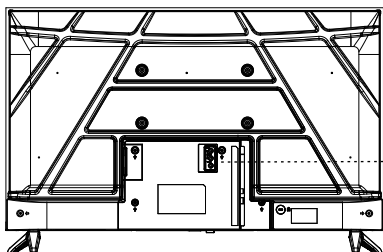

红色 (右音频信号线)
白色 (左音频信号线)
黄色 (视频信号线)



DVD



机顶盒 (STB)



便携式摄像机

■ AV IN

从外部 AV 设备接收音频和视频信号。

■ DIGITAL AUDIO OUT

使用光缆将电视音频信号输出到兼容的音频接收器。

■ EARPHONE (🎧)

将电视声音输出到连接的耳机。插入耳机时，扬声器将静音。

■ HDMI1/2

从外部 HDMI 设备接收 HDMI 输入信号。

注:
当你需要连接一个支持ARC功能的设备时，选择HDMI2

■ ANTENNA IN

连接同轴电缆以接收来自天线、电缆或卫星的信号。

■ LAN

有线网络端口。

■ USB1/2

连接 USB 存储设备。

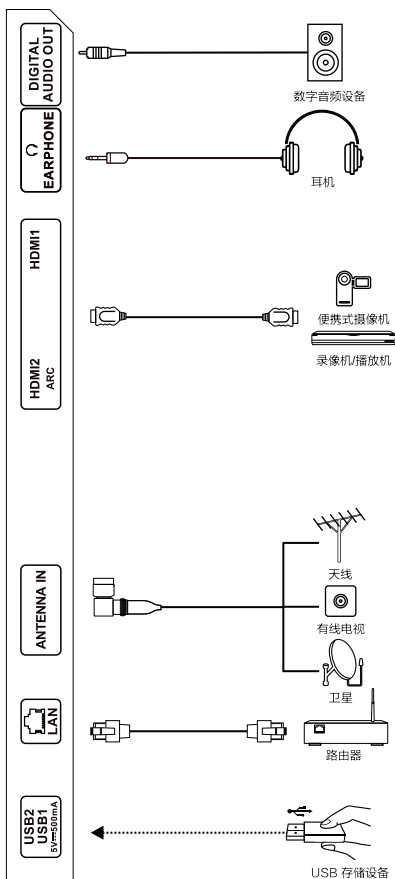

遥控器

注意:

- 1). 图片仅供参考。
- 2). 遥控器的图像、按钮和功能可能因地区或型号而异。
- 3). 只需在任何界面上按下 Google Assistant (🗨️) 按钮, 即可轻松快速地将蓝牙遥控器与电视配对。

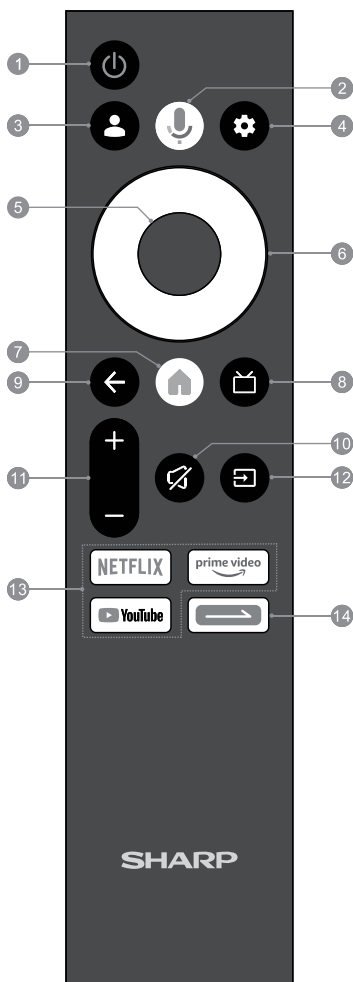

- 1. 电源 (🔌)**
打开电视, 或将电视转至快速启动/待机模式。
- 2. Google Assistant (🗨️)**
开始使用近场语音功能。
 - 短按此按钮可唤醒 Google Assistant。
 - 长按此按钮开始接收您的语音命令。在您讲话之后, 松开这个按钮, 以运行语音功能。
- 3. 配置 (👤)**
使用您的 Google 帐户登录, 享受您喜爱的娱乐节目
- 4. 仪表盘 (⚙️)**
访问您的 Google TV™ 的仪表盘菜单
- 5. 确定**
确认、进入或执行所选条目, 或访问频道列表。
- 6. 导航按钮 (上/下/左/右)**
浏览菜单选择您需要的内容, 或按上/下按钮更换频道
- 7. 主页 (🏠)**
进入主屏幕。
- 8. EPG (📺)**
访问 DTV 或在 DTV 模式下访问电子节目指南
- 9. 返回 (←)**
返回到上一级内容, 或退出当前操作屏幕。
- 10. 静音 (🔇)**
恢复电视静音。
- 11. 音量调高/调低 (+/-)**
调节音量
- 12. 源 (📺)**
访问源菜单,
- 13. 应用程序按钮**
快速直接地访问特定的应用程序。
- 14. 日常键按钮 (☰)**
此按钮作为快捷键, 用于快速访问您收藏的 应用程序 和功能。要开始使用此按钮功能, 长按以打开设置并选择您收藏的 应用程序 或功能。在设置之后, 短按以访问这些 应用程序 和功能。

主页屏幕

按下**主页** (🏠) 按钮进入主页屏幕，如下图所示。



- 1.客户中心：**添加其他家庭成员的 Google 帐户，或者在您的 Google TV 上设置和管理每个 Google 帐户。
- 2.导航栏：**选择打开标签，以获取各种内容。
- 3.搜索：**搜索电影、节目、应用程序等。
- 4.仪表板：**访问 Google TV 的仪表板菜单。
- 5.特色内容：**为您展示最热门的内容。
- 6.您的最佳选择：**突出显示所有内容类型中的最佳推荐。
- 7.您的应用程序：**显示 Google TV 上所有预装或用户安装的应用程序列表。

注意：

- 1).图片仅供参考。
- 2).主屏幕上的应用程序和内容因地区或型号而异。本手册不包括主屏幕上所有功能的操作说明。
- 3).由于网络故障、地区差异或服务中断，浏览器可能不支持某些网页或视频，这些内容缺失与电视无关。
- 4).如果服务提供商升级或修改他们的服务器，则某些应用程序可能无法在本电视上使用。
- 5).您的遥控器可能与某些网络应用程序不兼容，或者由于服务中断而出现故障，这与本电视无关。
- 6).为了获得更好的体验，请在访问互联网浏览器或应用程序时连接并使用外部鼠标或键盘。
- 7).部分机型支持用户安装 apk，用户在使用该功能时，应确保 apk 的正确性、安全性、兼容性和合法性，并对由此产生的任何义务负责。
- 8).有些型号支持用户安装和使用文件管理器应用程序，使用此功能时，用户不应修改或删除系统文件，否则将导致电视功能问题，客户应对因此产生的功能问题负责。
- 9).网络应用程序内容和服务由网络应用程序提供商通过网络和传输设施进行控制，由于制造商无法控制或被告知上述变更，网络应用程序内容和服务可能随时被更改、暂停、删除、终止或中断或无效访问，恕不另行通知。制造商进一步声明，对由于包括但不限于网络连接或通信线路故障、技术更新或网络应用提供商更改、暂停、中断、终止、禁用或删除任何内容或服务等原因而导致客户无法使用网络应用内容和服务，制造商不承担任何责任或义务。

基本功能

注意：按源(☐)按钮并从快捷菜单中选择虚拟键盘，彩色按钮(红/绿/黄/蓝)和播放与暂停按钮(▶ & II)会在虚拟键盘中列出。



注意：图片仅供参考。

频道列表

在电视模式下观看节目时，按**确定**按钮访问频道列表。

1) 在频道列表中：

- 按虚拟键盘上的**红色**按钮来管理频道。
- 按虚拟键盘上的**绿色**按钮来操作频道。
- 按虚拟键盘上的**黄色**按钮选择其他类型的频道列表，或访问收藏夹列表。
- 按虚拟键盘上的**蓝色**按钮，将频道添加到所需的收藏夹列表中。

2) 在播放收藏夹列表中的收藏频道时，您只能在按下**上/下**按钮时切换到播放其他收藏频道。如果是这样，当您想要观看所有保存的频道时，您可以按虚拟键盘中的**黄色**按钮来选择“所有频道”类型。

电子节目指南



注意：图片仅供参考。

电子节目指南由节目提供商提供，并提供关于要播放的节目的信息。您可以通过按遥控器上的**EPG** (☐) 按钮在 DTV 模式下访问它。

- *按虚拟键盘上的**红色**按钮可查看前一天的节目信息。
- *按虚拟键盘上的**绿色**按钮可查看下一天的节目信息。
- * (可能不可用) 按虚拟键盘上的**黄色**按钮可查看当前节目的更多详细信息。
- *按虚拟键盘上的**蓝色**按钮可选择所需的节目类型。

时移 (Time-shift)

当您的观看被中断或延迟时，时移用于录制 DTV 节目。要启用或禁用时移功能，请在 DTV 模式下选择 < 源 (源) 按钮 → 快捷方式 → TV 菜单 → 录制 → 时移模式 >。启用时移功能后，按虚拟键盘上的 **暂停 (II)** 按钮，暂停播放 DTV 节目并开始录制节目。按下虚拟键盘中的 **播放 (▶)** 按钮，从您暂停的时间继续播放节目。按下虚拟键盘上的 **退出** 按钮，会弹出一个提示提醒，询问您是否要停止时移功能。

注意：

- 1) 在进行时移之前，您最好格式化您的 USB 设备，以确保有足够的空间用于时移录制。如果您在 USB 设备上保存了任何数据，请在格式化之前备份数据。格式化 USB 设备将会擦除 USB 设备上保存的所有数据。
- 2) 播放完节目或停止时移功能后，已录制的时移节目会自动清除。
- 3) 如果时移录制时间过长，没有更多空间来录制新节目，电视将从录制开始处自动开始播放节目，以释放已播放的节目空间来录制新节目。

用户设置

初始设置

当您第一次打开电视时，会出现一个向导来指导您完成以下设置。

第 1 步：连接蓝牙遥控器。

第 2 步：根据需要选择菜单语言。

第 3 步：选择您的地区或国家。

第 4 步：选择设置 Google TV 或设置基本电视。建议您选择“设置 Google TV”来享受 Google TV 的全部智能功能。

设置 Google 帐户后

*电视将请求自动频道扫描，即使之前已经完成扫描。因此，在使用电视功能之前，需要设置 Google 帐户。

*** 对于某些国家，您可以使用手机或电视遥控器来设置 Google TV。如果您准备用手机设置电视，请根据电视和手机屏幕上的说明进行操作。如果您准备用电视遥控器设置电视，请选择“改为在电视上设置”；然后继续下面的步骤。***

第 5 步：将电视连接到所需的无线网络。

第 6 步：使用您的 Google 帐户登录。

第 7 步：阅读并接受 Google 服务条款和隐私政策。

第 8 步：阅读以接受 Google 服务设置。

第 9 步：了解 Google Assistant 的主要功能，选择“继续”进入下一步。

第 10 步：选择是否让 Google Assistant 搜索您的所有应用程序。

第 11 步：选择安装 Google 推荐的应用程序。根据 Google 服务的不同，此步骤可能不可用。

第 12 步：打开或关闭 LCN（逻辑频道号）开关。

第 13 步：设置家长锁系统的密码。

第 14 步：在“家庭”和“商店”之间选择电视使用环境。推荐将“家庭”模式用于正常的家庭观看，将“商店”模式用于在商店中展示电视等。在“商店”模式下会消耗更多的电能。

第 15 步：选择调谐器模式。

第 16 步：开始“频道扫描”。

第 17 步：阅读并接受最终用户许可协议。

第 18 步：安装您的应用程序。

第 19 步：开始探索您的 Google TV。

注意：

1) 初始设置中的设置可能因地区或型号而异。

2) 初始设置中的设置可能会更改，恕不另行通知，这取决于 Google 的要求。您需要根据屏幕上的指示完成所有设置。

3) 如果您想在第一次后重新启动初始设置，请选择 < 仪表板 (⚙) 按钮 → 设置 (⊗) → 系统 → 关于 → 重置 >

用户设置

源菜单

按**源** (源) 按钮进入源菜单，如右图所示。

- **信号源**：更改输入源。
- **捷径**：使用每个快捷功能的设置。
- **最近使用**：显示最近使用的应用程序列表。

注意：

- 1) 图片仅供参考。
- 2) 信号源菜单中的项目可能因地区、型号或输入信号源而异。



Tv主菜单

在电视模式下，按**源** (源) 按钮访问源菜单，然后按**上/下/左/右**和**确定**按钮选择并访问电视菜单，如右图所示。

• 频道

按**上**按钮选择频道菜单。

- ***收视指南**：在 DTV 模式下访问电子节目指南。
- ***频道**：搜索可用的电视频道。
- ***频道管理**：管理频道。

• 电视选项

- ***信号源**：打开来源列表。
- ***图像**：访问图像菜单。
- ***屏幕**：选择屏幕模式。
- ***声音**：访问声音菜单。
- ***电源**：设置电源选项以自动关闭电视或仅关闭图像。
- ***家长控制**：家长锁定系统的设置。
- ***高级选项**：设置高级频道选项。
- ***设置**：访问主菜单设置。

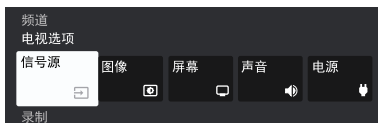

• 录制

按**下**按钮可选择“录制”菜单。

- ***设备信息**：显示连接的 USB 存储设备的详细信息，并设置最佳使用时移功能。
- ***时移模式**：启用或禁用时移功能。

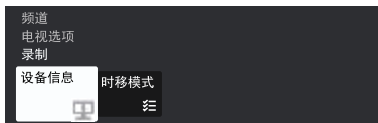

注意：

- 1) 图片仅供参考。
- 2) 电视菜单中的设置可能因地区、型号或输入源而异。

用户设置

仪表板菜单

按**仪表板 (⚙️)** 按钮进入仪表板菜单，如右图所示。

1. **日期和时间**: 显示日期和时间。
2. **设置**: 访问主菜单设置。
3. **客户中心**: 添加其他家庭成员的 Google 帐户，或者在您的 Google TV 上设置和管理每个 Google 帐户。
4. **Screensaver**: 打开屏幕保护程序模式。
5. **输入**: 访问来源列表。
6. **图像**: 访问图像菜单。
7. **声音**: 访问声音菜单。
8. **Wi-Fi**: 将电视连接到网络。
9. **Accessibility**: 启动无障碍功能，帮助视障或听障观众轻松理解和使用电视。
10. **通知**: 显示最佳使用 Google TV 的详细通知或提示。



注意:

- 1) 图片仅供参考。
- 2) 仪表板菜单中的设置可能因地区、型号或输入源而异。

主菜单

第 1 步: 在仪表板菜单中，选择“设置 (⚙️)”进入主菜单设置，如下图所示。

第 2 步: 按**上/下**和**确定**按钮，选择并进入子菜单。

第 3 步: 按**上/下/左/右**和**确定**按钮选择和调整项目。

第 4 步: 按**返回 (←)** 按钮返回上一级菜单，或退出主菜单设置。

注意:

- 1) 图片仅供参考。
- 2) 主菜单中的设置可能因地区、型号或输入源而异。



用户设置

建议

显示推荐的或未完成的设置，供您以最佳方式使用 Google TV。

常规设置

调整与您的 Google TV 设备和系统相关的设置。

■ 频道和输入

搜索可用的电视频道，或设置输入源。

- **频道：**搜索可用的电视频道。

*** 卫星频道调谐***

要在**频道**中搜索卫星频道，请参考以下步骤：

第 1 步：将卫星同轴电缆连接到电视机相应的天线端口。

第 2 步：打开电视，按下**源 (☐)** 按钮，在信号源列表中选择“卫星”作为输入信号源。

第 3 步：选择< **仪表板 (⚙)** 按钮 → 设置 (⊗) → 频道和输入 → 频道 → 卫星 >，以访问以下卫星调谐菜单界面。

***频道安装模式：**在“首选卫星”和“普通卫星”之间选择所需的卫星频道安装模式。

***卫星重新扫描：**自动搜索卫星频道。

***添加卫星：**添加新卫星。

***卫星更新：**搜索以更新卫星数据。

***卫星手动微调：**手动搜索卫星频道。



注意：图片仅供参考。

注意：只能在用于自动频道扫描的卫星上进行手动调谐。如果在手动调谐菜单中选择了其他卫星，请从频道菜单中重新进行自动扫描，然后进行手动调谐。

- **频道：**设置输入源。
 - *设置备用或未连接的输入。
 - *打开或关闭 HDMI CEC 链接功能，选择是否控制连接的 HDMI 设备。
 - *选择关闭电视时是否关闭连接的 HDMI 设备。
 - *选择在接通连接的 HDMI 设备时是否接通电视。
 - *显示 HDMI EDID 版本。
 - *显示 CEC 设备列表。

■ 显示和声音

调整与图像或声音质量相关的设置。

图像：调整与图像质量相关的设置。

- ***图片模式：**根据您的观看环境选择图像模式。选择可能因输入源而异。
- ***背光：**调整屏幕的背光。仅当“自动背光”关闭时才可用。
- ***自动背光：**打开以根据输入信号自动调整屏幕背光。
- ***亮度：**调整图像的亮度。
- ***对比度：**调整图像明暗区域的差异。
- ***饱和度：**相对于颜色本身的亮度调整颜色的丰富度。
- ***色调：**调整图像的色调。
- ***锐度：**调整图像的边缘。

用户设置

***高级设置：**调整高级图像设置。选项可能因地区、型号或输入源而异。

- **色温：**调整图像的整体色调。
- **数字降噪：**去除图像信号中的噪声。
- **MPEG数字降噪：**减少压缩或转换 MPEG 信号时产生的噪音。
- **极致生动：**打开或关闭最大鲜艳模式。
- **动态亮度控制：**根据输入信号自动调整画面亮度。
- **区域对比度控制：**控制局部对比度。
- **动态配色增强器：**选择动态颜色增强器的效果。
- **肤色：**设置肤色。
- **DI 电影模式：**抑制图像抖动，实现动态画面的稳定流畅播放。
- **蓝色延伸：**打开或关闭蓝色拉伸功能。
- **灰度系数：**调整原始图像的光强度。
- **游戏模式：**在画面模式为“游戏”时自动开启。
- **ALLM：**打开或关闭 ALLM 模式。
- **PC 模式：**打开或关闭 PC 模式。
- **HDMI RGB 范围：**设置 HDMI RGB 范围。
- **护眼模式：**选择护眼模式的效果。
- **色彩空间：**打开或关闭颜色空间。
- **颜色调谐器：**调整详细的颜色参数。
- **11 点白平衡校正：**调整白平衡校正的详细参数。

***重置为默认值：**将图像菜单中的所有用户设置恢复为默认值。

屏幕：选择屏幕模式。

声音：调整与声音质量相关的设置。

***声音风格：**根据您的观看要求选择声音模式。选择可能因输入源而异。

***平衡：**控制左右扬声器之间的声音平衡。

***低音：**调整声音的低频。

***高音：**调整声音的高频。

***环绕声：**打开或关闭环绕声系统。

***均衡器详情：**详细调整均衡器频率。仅当您在“声音风格”中选择了“用户”模式时，它才可用。

***自动音量控制：**打开以根据输入源自动调整音量。

***缩混模式：**在“立体声”和“环绕声”之间选择缩混模式

***对话增强器：**选择对话增强器的效果。

***重置为默认值：**将声音菜单中的所有用户设置恢复为默认值。

音频输出：选择数字音频输出模式，或调整数字音频延迟值。

■ 网络或互联网

*将电视连接到有线或无线网络。

*调整与网络配置相关的设置。

*设置 WOW/WOL/WOC 功能，通过网络连接在待机模式下打开电视。

用户设置

■ 帐户和登录

- *登录您的 Google 帐户，获取来自 Google 的新应用程序、推荐、电影等。
- *添加其他家庭成员的 Google 帐户。
- *在您的 Google TV 上设置和管理每个 Google 帐户。

■ 隐私设置

调整隐私相关设置，包括设备设置、帐户设置和应用程序设置。

■ 应用

- *显示最近打开、安装或系统应用程序的列表。
- *设置应用程序权限以使用特定功能。
- *设置特殊的应用程序访问，以充分利用应用程序。
- *针对未知来源的应用程序安装设置限制。

■ 系统

- *显示基本设备信息。
- *调整与 Google TV 的系统和功能相关的设置。
- *重新启动电视，或重新启动初始设置。

■ 遥控器和配件

连接蓝牙遥控器或其他蓝牙设备。在蓝牙搜索之前，请确保您已经打开了外部蓝牙设备的配对模式。对于电视随附的遥控器，请同时按住**返回** (←) 和**主页** (🏠) 按钮，以打开配对模式。对于其他蓝牙设备，请阅读它们自己的说明手册以打开配对模式。

注意：只需在任何界面上按下 Google Assistant (🗣️) 按钮，即可轻松快速地将蓝牙遥控器与电视配对。

■ 帮助和反馈

- *发送产品反馈以获得 Google 的帮助。
- *显示 Google TV 帮助的官方网站。

媒体播放器

媒体操作

您可以在电视上播放 USB 存储设备中的视频、音频和图像文件。

第 1 步。将您的 USB 存储设备连接到 USB 输入终端。

第 2 步。按 **主页 (🏠)** 按钮进入主屏幕。

第 3 步。按**上/下/左/右**和**确定**按钮，选择并输入“您的应用程序”列表中的“多媒体播放器”。

第 4 步。按**上/下/左/右**和**确定**按钮，选择所需的 USB 盘。

第 5 步。按**上/下/左/右**和**确定**按钮，选择所需的媒体文件。

第 6 步。按**确定**按钮，开始播放。

第 7 步。按**返回 (←)** 按钮，退出播放。

使用媒体播放器时的温馨提示

- 1).某些 USB 存储设备可能与本电视不兼容，无法流畅运行。
- 2).备份 USB 存储设备中的所有数据，以防数据因意外事故而丢失。我们对因误用或故障造成的损失不承担任何责任。数据备份是消费者的责任。
- 3).对于大文件，加载时间可能会稍长。
- 4).USB 存储设备的识别速度可能取决于每个设备。
- 5).连接或断开 USB 存储设备时，请确保电视未处于 USB 模式，否则 USB 存储设备或其中存储的文件可能会损坏。
- 6).请仅使用已经格式化为 Windows 操作系统提供的 FAT16、FAT32 或 NTFS 文件系统的 USB 存储设备。如果存储设备格式化为 Windows 不支持的不同实用程序，则可能无法识别。
- 7).使用需要电源的 USB 硬盘时，确保其额定电流不超过 USB 端子上标注的电流。如果 USB 硬盘的额定电流超过标示电流，电视可能会切换到待机模式或出现其他问题，您应该拔出 USB 硬盘并重新启动电视系统。
- 8).如果文件格式不受支持或损坏，将显示“不支持”消息。
- 9).FHD 大画面需要更长的时间来处理，这不是电视造成的。请耐心等待。
- 10).由于编码格式的变化或其他技术进步，本电视可能不支持某些已更改和升级的多媒体文件。

媒体播放器

看电影

观看电影时，按以下按钮控制电影播放。

按钮	功能
OK	暂停或播放。
⚙️	访问仪表盘菜单。
▲	访问电影菜单设置。
▼	显示电影播放列表。
◀ or ▶	快进或快退。

播放音乐

播放音乐时，按以下按钮控制音乐播放。

按钮	功能
OK	暂停或播放。
⚙️	访问仪表盘菜单。
▲	访问音乐菜单设置。
▼	显示音乐播放列表。
◀ or ▶	短按可选择上一首或下一首音乐。 长按可快进或快退。

浏览照片

浏览照片时，按以下按钮来控制照片播放。

按钮	功能
OK	访问照片菜单设置。
⚙️	访问仪表盘菜单。
▲ or ▼	显示照片播放列表。
◀ or ▶	跳到上一张或下一张照片。

故障排除

在致电维修技术人员之前，请查看下表，了解症状的可能原因和一些解决方案。

■ 一般问题/解决方案

遥控不起作用

- *更换电池。
- *检查电池是否安装正确。
- *检查主电源是否连接。
- *检查遥控器和遥控器之间是否有一些物品。

信号差

- *这通常是由电子设备或无线电干扰源的干扰造成的。

■ 图像和声音/解决方案

没有图像，没有声音

- *检查信号源。
- *将其他电气设备插入插座，检查它是否工作或接通。
- *检查电源插头是否与插座接触良好。

没有声音，图像正常

- *如果没有声音，请取消静音或提高音量。
- *打开声音菜单并调节“平衡”

异常图像

- *对于没有颜色或图像质量差的情况，您可以：
 1. 在图像菜单设置中调整颜色选项。
 2. 让电视与其他电子设备保持足够的距离。
 3. 试试其他频道。
- *电视信号不好（显示马赛克或雪花）
 1. 检查信号电缆并调整天线。
 2. 微调频道。
 3. 试试其他频道。

■ 媒体播放器/解决方案

“此文件无效”/“不支持的音频”出现，或音频正常但视频不正常，或视频正常但音频不正常。

- *媒体文件可能已损坏，请检查该文件是否可以在 PC 上播放。
- *检查是否支持视频和音频编解码器。

■ 浏览器/解决方案（可能不可用）

网络故障

- *检查路由器是否工作正常。
- *确保电视已成功连接到路由器。

■ 浏览器/解决方案（可能不可用）

网页无法完全显示

- *当前网页的某些第三方扩展可能不受支持，请关闭当前网页。

浏览器被强制关闭

- *当前网页可能包含太多内容，导致内存不足，浏览器关闭。

智能手机投屏：

- 检查电视和智能手机是否连接到同一个无线网络。
- 检查是否使用了 Google 投屏应用程序。
- 一些智能手机可能无法正常工作或不受支持。

规格

注意：规格可能因地区或型号而异。

项目		模型	2T-C32GH3000X
液晶面板			80 厘米
分辨率			1,049,088 像素 (1366 x 768)
视频彩色系统			PAL/SECAM/NTSC 3.58/NTSC 4.43/PAL 60
电视功能	电视标准	模拟	PAL: B/G, D/K, I SECAM: B/G, D/K, K/K1 NTSC: M
		数字的	DVB-T / DVB-T2 (仅适用于亚洲)
	接收频道	VHF/UHF	44.25 - 863.25 MHz
	电视调谐系统		自动预置
	立体声/双语		NICAM: B/G, I, D/K A2 立体声: B/G MTS:M
音频放大器			总计 16W (8W x 2)
终端	RF		75Ω DIN 型
	HDMI 1		HDMI
	HDMI 2		HDMI, ARC
	USB1		USB 2.0 (DC5V 500 mA 输出)
	USB2		USB 2.0 (DC5V 500 mA 输出)
	LAN		网络连接器(10/100 BASE-T)
	EARPHONE		耳机连接器
	DIGITAL AUDIO OUT		光学 S/PDIF 数字音频输出
	AV IN		音频和视频输入
Wi-Fi 协议			IEEE 802.11 a/b/g/n/ac 2T/2R 双频带
Wi-Fi 安全性			WPA3-Personal, WPA2-Personal, WPA-Personal
Bluetooth (蓝牙)			V2.1 + EDR / 4.2 / 5.1
OSD 语言			英语/南非荷兰语/波斯尼亚语/捷克语/丹麦语/德语/爱沙尼亚语/西班牙语/法语/克罗地亚语/印度尼西亚语/意大利语/斯瓦希里语/拉脱维亚语/立陶宛语/匈牙利语/马来西亚语/荷兰语/挪威语/波兰语/葡萄牙语/罗马尼亚语/阿尔巴尼亚语/斯洛伐克语/斯洛文尼亚语/芬兰语/瑞典语/越南语/土耳其语/希腊语/塞尔维亚语/立陶宛语/马其顿语/蒙古语/俄语/乌克兰语/格鲁吉亚语/希伯来语/阿拉伯语/波斯语/阿姆哈拉语/印地语/泰米尔语/泰语/缅甸语/韩语/简体中文/繁体中文/日语
电源要求			AC 100 - 240V, 50/60 Hz
功耗 (待机)			60W (0.5W)
尺寸	不带支架, 宽x高x深 (毫米)		716 X 426 X 83
	带支架, 宽x高x深 (毫米)		716 x 466 x 178
不带支架 (带支架) 的重量			3.3 千克 (3.4 千克)
工作温度			0°C 到 + 40°C

规格

注意：规格可能因地区或型号而异。

项目		模型	2T-C43GH3000X
液晶面板			109 厘米
分辨率			2,073,600 像素 (1920 x 1080)
视频彩色系统			PAL/SECAM/NTSC 3.58/NTSC 4.43/PAL 60
电视功能	电视标准	模拟	PAL: B/G, D/K, I SECAM: B/G, D/K, K/K1 NTSC: M
		数字的	DVB-T / DVB-T2 (仅适用于亚洲)
	接收频道	VHF/UHF	44.25 - 863.25 MHz
	电视调谐系统		自动预置
	立体声/双语		NICAM: B/G, I, D/K A2 立体声: B/G MTS:M
音频放大器			总计 16W (8W x 2)
终端	RF		75Ω DIN 型
	HDMI 1		HDMI
	HDMI 2		HDMI, ARC
	USB1		USB 2.0 (DC5V 500 mA 输出)
	USB2		USB 2.0 (DC5V 500 mA 输出)
	LAN		网络连接器(10/100 BASE-T)
	EARPHONE		耳机连接器
	DIGITAL AUDIO OUT		光学 S/PDIF 数字音频输出
	AV IN		音频和视频输入
Wi-Fi 协议			IEEE 802.11 a/b/g/n/ac 2T/2R 双频带
Wi-Fi 安全性			WPA3-Personal, WPA2-Personal, WPA-Personal
Bluetooth (蓝牙)			V2.1 + EDR / 4.2 / 5.1
OSD 语言			英语/南非荷兰语/波斯尼亚语/捷克语/丹麦语/德语/爱沙尼亚语/西班牙语/法语/克罗地亚语/印度尼西亚语/意大利语/斯瓦希里语/拉脱维亚语/立陶宛语/匈牙利语/马来西亚语/荷兰语/挪威语/波兰语/葡萄牙语/罗马尼亚语/阿尔巴尼亚语/斯洛伐克语/斯洛文尼亚语/芬兰语/瑞典语/越南语/土耳其语/希腊语/塞尔维亚语/立陶宛语/马其顿语/蒙古语/俄语/乌克兰语/格鲁吉亚语/希伯来语/阿拉伯语/波斯语/阿姆哈拉语/印地语/泰米尔语/泰语/缅甸语/韩语/简体中文/繁体中文/日语
电源要求			AC 100 - 240V, 50/60 Hz
功耗 (待机)			74W (0.5W)
尺寸	不带支架, 宽x高x深 (毫米)		955 X 559 X 84
	带支架, 宽x高x深 (毫米)		955 x 603 x 212
不带支架 (带支架) 的重量			5.5 千克 (5.6 千克)
工作温度			0°C 到 + 40°C

许可



Google TV is the name of this device's software experience and a trademark of Google LLC. Google, YouTube, Google Cast and YouTube Music are trademarks of Google LLC.



The terms HDMI, HDMI High-Definition Multimedia Interface, HDMI Trade dress and the HDMI Logos are trademarks or registered trademarks of HDMI Licensing Administrator, Inc.



Manufactured under license from Dolby Laboratories. Dolby, Dolby Audio, and the double-D symbol are trademarks of Dolby Laboratories Licensing Corporation.

终端用户许可协议

1. 总则

请您在使用此电视机之前仔细阅读本协议，使用此电视机表示您已接受本协议，我们保留本终端用户许可协议中未明确授予您的所有权利。

本终端用户许可协议（"EULA"是您（此电视机的使用者）和我们（此电视机的制造商）之间有关该电视软件的一项法律协议，该电视软件是由我们、第三方应用商或者第三方许可者所拥有。该电视软件包括本电视机所用到的软件，包含更新或修改的软件，由我们或第三方提供，无论是存储在媒体上，还是通过任何方式下载到此电视机上的软件，但不包括开源软件。

2. 软件许可

除非符合此处规定，否则您不能使用该电视软件，我们和第三方许可者只允许您在此电视机上使用该电视软件。该电视软件可能会自动创建数据文件，您同意任何此类数据文件都应被视为该电视软件的一部分。该电视软件是作为单一产品授权使用的，除非获得我们的明确授权，否则您不可将其分割并在其它设备上使用。第三方软件可能附有单独许可，在这种情况下，您同意第三方许可将控制您对第三方软件的使用。

您同意不能对该电视软件全部或部分地进行修改、逆向工程、解压或者拆卸，或将该电视软件全部或部分地用于本 EULA 规定以外的任何用途，此外，您不得出租、租赁、分许可或出售该电视软件，不得（1）绕过、修改、废除或规避该电视软件或相关机制的任何功能或保护；（2）删除、更改、覆盖或污损该电视软件上的任何商标或通告，我们和第三方许可者保留本 EULA 中未明确授予您的所有权利。

此电视机中包含开源软件，其受开源许可的约束，此电视机中使用了一些 GPL 可执行文件和 LGPL / MPL 库受 GPL2.0/LGPL2.1/MPL1.1 许可协议的约束。若相应的许可方有要求，我们可以特此提供一份完整的本电视机中所用到的受版权保护的开源软件包中相应源代码的副本，源代码副本的提供是有时间限制的，有效期自本电视机的销售之日起，为三期（3）年。若要取得源代码，请与我们的服务中心联系。

3. 软件更新或修改

我们或第三方可能会随时更新或修改软件，例如，但不限于：为了纠正错误、改善功能和增强安全性能的目的，这些更新或修改可能会更改或删除该电视软件功能或其他方面的性质，包括您所依赖的功能。

更新或修改后的软件将由我们或第三方通过网络或其他方式提供给您，您可以根据实际需要决定是否接受或安装这些更新或修改。一般来说，针对我们提供的更新或修改，我们建议您接受或安装，以便您更好地使用此电视机，一些由我们提供的系统关键性的更新或修改，可能决定着您是否能够继续正常地使用此电视机，我们可能会不需要您的接受而自动下载并安装这些更新或修改。针对第三方提供的更新或修改，完全由您自己决定并承担风险或责任。请您不要在软件更新期间关闭此电视机，否则可能会引起严重的问题并由您自己承担相关责任。

4. 基于网络的服务和内容

此电视机具有智能性功能，可以访问所选择的第三方应用商所提供的应用服务（服务）。智能性功能需要网络连接，您访问服务的能力，以及所呈现的服务质量，取决于您的网络提供商的服务和条款，以及您所使用的网络速度。

内容，由第三方应用商提供，包括但不限于：数据、音乐、声音、音频、图像、图形、相片、软件、文本、视频、消息、标签或其他材料，服务的可用性也完全由第三方应用商自行决定和控制，每个第三方应用商的服务和内容是根据该第三方应用商的条款和条件予以提供的。

服务和内容仅用于您私人观看，不得用于任何收取入场费或观赏费的观看，展览或活动场所，也不得用于任何公开性展览或观看。服务和内容并非适用于所有语种，所有国家或地区，第三方保证服务和内容适用于或可用于任何特定地点。当您选择使用或访问服务和内容时，您应主动遵守任何适用的法律，包括但不限于：适用的地方法律，隐私和数据收集法。

部分网页或视频可能由于网络故障、区域不同或服务中断而不受支持，这与此电视机无关。部分机型可能支持您自己安装 apk，在使用此功能时，您应确保 apk 的正确性、安全性、兼容性和合法性，并承担由此产生的任何责任。部分机型可能支持您自己安装和使用文件管理器，

终端用户许可协议

在使用此功能时，不能修改或删除系统文件，否则将导致此电视机功能故障或数据丢失，并由承担由此产生的任何责任。

服务和内容是由第三方应用商通过网络和传输设施予以控制的，服务和内容随时可能发生更改、暂停、删除、终止、中断或无效访问而无事先通知，故制造商无法控制并且无法获悉上述更改，所以我们进一步声明，我们不承担用户无法使用网络应用服务和内容的任何责任，包括但不限于，由于网络连接或通信线路、技术更新或网络应用商更改、暂停、中断、终止、禁用或删除任何服务或内容所造成的故障。

5. 内容版权

我们不对由第三方创建或拥有的内容负责，您可能会作为服务的一部分访问此内容，或通过使用服务访问此内容。任何相关责任将由该第三方内容的创建者、所有者或许可者承担，而不是由我们承担。

您理解、承认并同意，受第三方内容的创建者、所有者或许可者所有权和知识产权的保护，未经创建者、所有者或许可者许可，您不得对任何第三方内容全部或部分地进行修改、逆向工程、复制、出租、租赁、贷款、销售、转售、再传输、分销、交易、公开展示或创作其衍生作品。

内容创建者、所有者或许可者可能使用" Microsoft PlayReady "内容访问技术(" PlayReady ")来保护他们的知识产权，包括版权内容。此电视机使用" PlayReady "技术访问受" PlayReady "保护的内容和/或受" WMDRM "保护的内容(" WMDRM "是指 Microsoft Window Media 的数字版权管理技术)。如果此电视机未能适当地强制执行对内容使用的限制，则内容创建者、所有者或许可者可能要求Microsoft公司(" Microsoft ")撤销此电视机使用受" PlayReady "保护内容的权限，撤销并不影响未受保护的内容或受其他内容访问技术保护的内容。内容创建者、所有者或许可者可能要求您升级" PlayReady "以访问其内容，如果您拒绝升级，您将无法访问需要升级的内容。

内容创建者、所有者或许可者可能使用" Widevine DRM "内容访问技术来保护他们的知识产权，包括版权内。此电视机使用" Widevine DRM "技术访问受" Widevine DRM "保护的内容，如果此电视机未能适当地强制执行对内容使用的限制，则内容创建者、所有者或许可者可能要求Widevine Technologies公司撤销此电视机使用受" Widevine DRM "保护内容的权限，撤销并不影响未受保护的内容或受其他内容访问技术保护的内容。内容创建者、所有者或许可者可能要求您升级" Widevine DRM "以访问其内容，如果您拒绝升级，您将无法访问需要升级的内容。

6. 未成年人使用

如果您是允许法定成年年龄以下的人("未成年人")使用服务或内容的父母或监护人，您同意：

(1) 监督未成年人使用服务或内容；(2) 承担与未成年人使用服务或内容有关的一切风险，包括通过服务接收和传递信息和材料，以及为数字产品、服务和内容所进行的交易；(3) 承担因未成年人使用服务和内容而产生的任何责任。(4) 未成年人访问并使用服务和内容时，须受本EULA的约束。

7. 隐私协议

我们不会通过此电视机收集或使用任何个人信息，但是，当您访问第三方应用商提供的，我们无法控制的应用程序时，第三方可能会通过使用" Cookies "或其他类似技术收集或接收某些信息，我们不负责第三方收集的任何信息的安全或隐私，您应当谨慎使用，并查阅您所使用的第三方服务的隐私声明。

例如，但不限于：当您观看由第三方应用商提供的视频，或者访问由第三方应用商提供的服务或内容时，该应用商可能会收集或接收此电视机的相关信息（IP地址、设备标识等）、您所需求的交易信息（您购买或出租视频的需求）、以及您对服务和内容的使用信息等。

为了允许您访问、浏览或使用服务和内容，第三方可能会要求您建立一个用户帐户，您必须为此提供真实、准确、最新和完整的个人信息，您负责维护所有此类帐户密码的机密性。

第三方可能会收取其内容或服务的使用费用，除非第三方应用商事先获得您的同意，否则不会收取您访问任何一部分或所有服务和内容的费用，如果您不同意此类收费，您可能无法访问相应的付费内容或服务。

终端用户许可协议

当您使用该电视软件或访问服务时，第三方可能会收集此电视机的数据、控制和/或监视此电视机或与此电视机相连接或相交的其它设备，我们对您与第三方之间所进行的任何活动不予负责。

8. 免责声明

该电视软件、服务和内容都是“按现状”和“可提供情况”提供给您的，不带有任何种类的保证。我们、第三方应用商和第三方许可者拒绝提供任何明示或暗示的保证和条件，包括但不限于：有关不侵权、所有权、适销性和适合某一特定用途的暗示保证。我们、第三方应用商和第三方许可者不保证该电视软件、服务或内容将会满足您的要求，或该电视软件、服务或内容在操作过程中将不受干扰或无差错。此外，我们、第三方应用商和第三方许可者针对该电视软件、服务或内容的使用或使用结果的正确性、准确性、可靠性或其他方面不做任何保证、声明或条件，我们所提供的任何口头或书面资料或意见，不会做为任何保证或条件，或以任何方式改变本免责声明。如果该电视软件、提供该电视软件的媒介、服务或内容存在缺陷，您须承担所需服务、修理或改正的全部费用。

您理解、承认并同意：服务、内容及其相关软件是由第三方应用商提供的，我们是无法控制的。相应第三方应用商或其他第三方应用商完全承担有关其内容和软件的选择、提供、质量、图片大小和可用性方面的责任，您同意遵守第三方为其服务、内容和软件设定的任何和所有条款和条件。

您理解、承认并同意：通过使用服务下载或获得的任何内容或软件都是由您自行决定并承担风险的，并且您应该负责由此导致的任何后果，包括病毒、间谍软件、蠕虫或恶意软件所造成的任何损失或伤害。

9. 责任限制

在适用法律允许的范围内，无论是在合同、侵权行为（包括过失）或任何责任理论中，不管是否已通知我们此类损失或损害的可能性，针对以下情况，我们概不负责：

- (1)任何间接的、附带的、特殊的、性的或果性的损害；
- (2)任何收入、业务、实际或预期利润、机会、商誉或声誉（不论是直接或间接的）的损失；
- (3)对数据的任何损害或破坏（不论是直接或间接的）；
- (4)因以下原因而造成的任何损失或损害：（A）您对服务的使用；（B）您对任何广告的完整性、准确性或存在性的依赖；（C）您与任何服务或内容的第三方应用商，包括广告商及赞助商之间的任何关系或交易；（D）对服务的任何更改，或者有关服务或其中一部分的任何永久性或临时性暂停。

10. 纠纷处理

如因本 EULA 或您使用该电视软件而引起的纠纷、争议或分歧不能被友好解决，则应由您所居住地具有非专属管辖权的法院管辖，尽管有上述规定，我们仍可在任何司法管辖区内申请我们认为必要的或者适当的强制令救济（或同等类型的紧急法律救济）。

11. 适用法律和可分割性

本 EULA 是由您居住地所在司法管辖区内的法律管辖，未考虑其法律冲突条款，如果本 EULA 的任何规定被认为无效、失效、不可强制执行或非法，则其它规定应当继续充分有效。

12. 协议终止

本 EULA 终止后失效，如果您不遵守本 EULA 的任何条款，您在本 EULA 下的权利将自动终止或以其他方式停止生效而无事先通知，在本 EULA 终止后，您将停止使用该电视软件，并且您将无权向我们、第三方许可者或第三方应用商追索。

13. 全部协议和管辖语言

本 EULA 构成您与我们之间有关该电视软件的全部协议，并取代以前或现在所有有关该电视软件或本 EULA 所涵盖的任何其他事项的口头或书面沟通、建议和陈述。本 EULA 的任何翻译版本只为给您提供方便，或应当当地需求而提供，如果英文版本与任何非英文版本之间有矛盾或争议，则以英文版本为准。

SHARP

SHARP CORPORATION