



Refrigerator user manual

English

imagine the possibilities

Thank you for purchasing a Samsung product.

To receive a more complete service,
please register your product at
www.samsung.com/register

Free Standing Appliance

SAMSUNG

Safety information

SAFETY INFORMATION



- Before operating the appliance, please read this manual thoroughly and retain it for your reference. Use this appliance only for its intended purpose as described in this instruction manual. This appliance is not intended for use by persons (including children) with reduced physical, sensory or mental capabilities, or lack of experience and knowledge, unless they have been given supervision or instruction concerning use of the appliance by a person responsible for their safety.
- Because these following operating instructions cover various models the characteristics of your refrigerator may differ slightly from those described in this manual.

CAUTION/WARNING SYMBOLS USED

	Indicates that a danger of death or serious injury exists.
	Indicates that a risk of personal injury or material damage exists.
	Represents something you must NOT do.
	Represents something you must NOT disassemble.
	Represents something you must NOT touch.
	Represents something you must follow.
	Indicates that you must disconnect the power plug from the socket.
	Represents a ground is needed to prevent electric shock.
	It is recommended that this symbol be handled by service man.
	Note.

These warning signs are here to prevent injury to you and others. Please follow them explicitly.

After reading this section, keep it in a safe place for future reference.

CE Notice

This product has been determined to be in compliance with the Low Voltage Directive (2006/95/EC), the Electromagnetic Compatibility Directive (2004/108/EC) and the Eco-Design Directive(2009/125/EC) implemented by Regulation (EC) No 643/2009 of the European Union. (for products sold in European countries only)



SEVERE WARNING SIGNS FOR DISPOSAL

- When disposing of this or other refrigerator/s, remove the door/door seals, door latch so that small children or animals cannot become trapped inside.
Children should be supervised to ensure that they do not play with the appliance.
If trapped inside, the child may become injury and suffocate to death.
- Keep all packaging materials well out of the reach of children, as packaging materials can be dangerous to children.
- If a child places a bag over its head, it may result in suffocation.
- Please dispose of the packaging material for this product in an environmentally friendly manner.
- Leave the shelves in place so that children may not easily climb inside.
Ensure that none of the pipes on the back of the appliance are damaged prior to disposal.
- R-600a or R-134a is used as a refrigerant. Check the compressor label on the rear of the appliance or the rating label inside the fridge to see which refrigerant is used for your refrigerator. When this product contains flammable gas (Refrigerant R-600a), contact your local authority in regard to safe disposal of this product. Cyclopentane is used as a insulation blowing gas. The gases in insulation material require special disposal procedure. Please contact your local authorities in regard to the environmentally safe disposal of this product. Ensure that none of the pipes on the back of the appliances are damaged prior to disposal. The pipes shall be broke in the open space.



For R600a refrigerant models only

- This appliance contains a small amount of isobutane refrigerant(R600a), a natural gas with high environmental compatibility that is, however, also combustible. When transporting and installing the appliance, care should be taken to ensure that no parts of the refrigerating circuit are damaged. Refrigerant squirting out of the pipes could ignite or cause an eye injury. When refrigerant leaks from the pipe, avoid any naked flames and move anything flammable away from the product and ventilate the room immediately.
- Failing to do so may result in fire or explosion. In order to avoid the creation of a flammable gas-air mixture if a leak in the refrigerating circuit occurs, the size of the room in which the appliance may be sited depends on the amount of refrigerant used. Never start up an appliance showing any signs of damage. If in doubt, consult your dealer. The room must be 1 m³ in size for every 8 g of R600a refrigerant inside the appliance. The amount of refrigerant in your particular appliance is shown on the identification plate inside the appliance.



SEVERE WARNING SIGNS FOR INSTALLATION

- This refrigerator must be properly installed and located in accordance with the manual before it is used.
- Do not install the refrigerator in a damp place or place where it may come in contact with water.
- Deteriorated insulation of electrical parts may cause an electric shock or fire.
- Do not place this refrigerator in direct sunlight or expose to the heat from stoves, room heaters or other appliance.
- This appliance must be properly grounded. Do not ground the appliance to a gas pipe, plastic water pipe, or telephone line.
- You must ground the refrigerator to prevent any power leakages or electric shocks caused by current leakage from the refrigerator.
- This may result in an electric shock, fire, explosion, or problems with the product.
- Never plug the power cord into a socket that is not grounded correctly and make sure that it is in accordance with local and national codes.
- Plug the power plug into the wall socket firmly. Do not use a damaged power plug, damaged

power cord or loose wall socket.

- This may result in an electric shock or fire.
- Do not plug several appliances into the same multiple power board. The refrigerator should always be plugged into its own individual electrical which has a voltage rating that matched the rating plate.
- This provides the best performance and also prevents overloading house wiring circuits, which could cause a fire hazard from overheated wires.
- If the wall socket is loose, do not insert the power plug.
- There is a risk of electric shock or fire.
- Connect the power plug in proper position with the cord hanging down.
- If you connect the power plug upside down, wire can get cut off and cause fire or electric shock.
- Do not pull or excessively bend the power cord. Do not twist or tie the power cord. Do not hook the power cord over a metal object, place a heavy object on the power cord, insert the power cord between objects, or push the power cord into the space behind the appliance.
- When moving the refrigerator, be careful not to roll over or damage the power cord
- This may result in an electric shock or fire.
- Do not use a cord that shows cracks or abrasion damage along its length or at either end.
- If the power cord is damaged, have it replaced immediately by the manufacturer or its service agent.
- Do not bend the power cord excessively or place heavy articles on it.
- When moving the refrigerator, be careful not to roll over or damage the power cord.
- This constitutes a fire hazard.
- Make sure that the power plug is not squashed or damaged by the back of the refrigerator.
- Keep the packing materials out of reach of children.
- There is a risk of death from suffocation if children put them on their head.
- This appliance should be positioned in such a way that it is accessible to the power plug.
- Failing to do so may result in an electric shock or fire due to electric leakage.
- Do not install this appliance near a heater, inflammable material. Do not install this appliance in a humid, oily or dusty location, in

a location exposed to direct sunlight and water (rain drops).

- Do not install this appliance in a humid, oily or dusty location, in a location exposed to direct sunlight and water (rain drops).
- Do not install this appliance in a location where gas may leak.
 - This may result in an electric shock or fire.
- Do not stand on top of the appliance or place objects (such as laundry, lighted candles, lighted cigarettes, dishes, chemicals, metal objects, etc.) on the appliance.
 - This may result in an electric shock, fire, problems with the product, or injury.



CAUTION SIGNS FOR INSTALLATION

- Keep ventilation opening in the appliance enclosure or mounting structure clear of obstruction.
- Allow the appliance to stand for 2 hours after installation.
- The installation or any service of this appliance is recommended by a qualified technician or service company.
 - Failing to do so may result in an electric shock, fire, explosion, problems with the product, or injury.



SEVERE WARNING SIGNS FOR USING

- Do not touch the power plug with wet hands.
 - This may result in an electric shock.
- Do not store articles on the top of the appliance.
 - When you open or close the door, the articles may fall and cause personal injury and/or material damage.
- Do not put a container filled with water on the refrigerator.
 - If spilled, there is a risk of fire or electric shock.
- Children should be supervised to ensure that they do not play with the appliance.
- Keep fingers out of "pinch point" areas : clearances between the doors and cabinet are necessarily small. Be careful when you open the doors when children are in the area.
- Do not let children hang on the door. If not, a serious injury may occur.
- There is a Risk of children entrapment.

Do not let children enter inside of the refrigerator.

- Do not touch the inside walls of the freezer or products stored in the freezer with wet hands.
 - This may cause frostbite.
- Bottles should be stored tightly together so that they do not fall out.
- Never put fingers or other objects into the dispenser hole.
 - It may cause personal injury or material damage.
- Do not insert hands, feet or metal objects (such as chopsticks, etc.) into the bottom or the back of the refrigerator.
 - This may result in an electric shock or injury.
 - Any sharp edges may cause a personal injury
- Do not use or place any substances sensitive to temperature such as inflammable sprays, inflammable objects, dry ice, medicine, or chemicals near or inside of the refrigerator. Do not keep volatile or inflammable objects or substances (benzene, thinner, propane gas, alcohol, ether, LP gas and other such products etc.) in the refrigerator.
 - This refrigerator is for storing food only.
 - This may result in fire or explosion.
- This product is intended only for the storage of food in a domestic environment.
- Do not store pharmaceuticals products, scientific materials or temperature-sensitive products in the refrigerator.
 - Products that require strict temperature controls must not be stored in the refrigerator.
- Do not place or use electrical appliance inside the refrigerator/freezer, unless they are of a type recommended by the manufacturer.
- If you smell pharmaceutical or smoke, pull out power plug immediately and contact your Samsung Electronics service center.
- Do not attempt to repair, disassemble, or modify the appliance yourself.
 - Do not use any fuse(such as cooper, steel wire, etc.) other than the standard fuse.
 - When repairing or reinstalling the appliance is required, contact your nearest service center.
 - Failing to do so may result in an electric shock, fire, problems with the product, or injury.
- If any dust or water is in Refrigerator, pull out power plug and contact your Samsung Electronics service center.
- Otherwise there is a risk of fire.
- If gas leak is detected, avoid any naked flames

or potential sources of ignition and air the room in which the appliance is standing for several minutes.

- Do not use mechanical devices or any other means to accelerate the defrosting process, other than those recommended by the manufacturer.
- Do not damage the refrigerant circuit.
- Pull the power plug out of the socket before changing the interior lamps of the refrigerator.
 - Otherwise, there is a risk of electric shock.
- If you experience difficulty when changing the light, contact service agents.
- If the products equipped with LED Lamp, do not disassemble Lamp Cover and LED Lamp by yourself.
 - Please contact your service agents.
- Use only the LED Lamps provided by manufacturer or service agents.
- Do not spray volatile material such as insecticide onto the surface of the appliance.
 - As well as being harmful to humans, it may also result in an electric shock, fire or problems with the product.
- Do not use a hair dryer to dry the inside of the refrigerator.
- Do not place a lighted candle in the refrigerator for removing bad odours.
 - This may result in an electric shock or fire.
- Fill water tank, ice tray, water cubes only with potable water.



CAUTION SIGNS FOR USING

- When the refrigerator got wet by water, pull out the power plug and contact your Samsung Electronics service center.
- Wipe excess moisture from the inside and leave the doors open.
 - Otherwise, odor and mold may develop.
- Allow the appliance to stand for 2 hours after installation.
- To get Best performance of product,
 - Do not place foods too closely in front of the vents at the rear of the appliance as it can obstruct free air circulation in the freezer compartment.
 - Wrap the food up properly or place it in airtight containers before put it into the fridge or freezer.
 - Do not put any newly introduced food for freezing near to already existing food.
- Do not place carbonated or fizzy drinks in the

freezer compartment.

Do not put bottles or glass containers in the freezer.

- When the contents freeze, the glass may break and cause personal injury.
- Please observe maximum storage times and expiry dates of frozen goods.
- There is no need to disconnect the refrigerator from the power supply if you will be away for less than three weeks.
 - But, Remove all the food if you are going away for the three weeks or more.
 - Unplug the refrigerator and clean it, rinse and dry.



CAUTION SIGNS FOR CLEANING

- Remove all foreign substances such as dust or water from the power plug terminals and contact points using a dry cloth on a regular basis.
 - Unplug the power plug and clean it with a dry cloth.
 - Failing to do so may result in an electric shock or fire.
- Before cleaning or performing maintenance, unplug the appliance from the wall socket.
 - Failing to do so may result in an electric shock or fire.
- Do not clean the appliance by spraying water directly onto it. Do not use benzene, thinner or alcohol to clean the appliance.
 - This may result in discoloration, deformation, damage, electric shock or fire.
- Do not spray inflammable gas near the refrigerator.
 - There is a risk of explosion or fire.



ADDITIONAL TIPS FOR PROPER USAGE

- In the event of a power failure, call the local office of your Electricity Company and ask how long it is going to last.
 - Most power failures that are corrected in an hour or two will not affect your refrigerator temperatures.
 - However, you should minimize the number of door openings while the power is off.
 - But Should the power failure last more than 24 hours, remove all frozen food.

- If the key is provided with refrigerator, the keys should be kept out of the reach of children and not in vicinity of the appliance.
- The appliance might not operate consistently (possibility of defrosting of contents or temperature becoming too warm in the frozen food compartment) when sited for an extended period of time below the cold end of the range of temperatures for which the refrigerating appliance is designed.
- Do not store food which spoils easily at low temperature, such as bananas, melons.
- Your appliance is frost free, which means there is no need to manually defrost your appliance, as this will be carried out automatically.
- Temperature rising during the defrost can comply with ISO requirement.
But If you want to prevent an undue rise in the temperature of the frozen food while defrosting the appliance, please wrap the frozen food in several layers of newspaper.
- Do not re-freeze frozen foods that have thawed completely. Any increase in temperature of frozen food during defrosting can shorten its storage life.
- Contains fluorinated greenhouse gases covered by the Kyoto Protocol

SAVING ENERGY TIPS

- Install the appliance in a cool, dry room with adequate ventilation.
Ensure that it is not exposed to direct sunlight and never put it near a direct source of heat (radiator, for example).
- Never block any vents or grilles on the appliance.
- Allow warm food to cool down before placing it in the appliance.
- Put frozen food in the refrigerator to thaw.
You can then use the low temperatures of the frozen products to cool food in the refrigerator.
- Do not keep the door of the appliance open for too long when putting food in or taking food out.
The shorter time for which the door is open, the less ice will form in the freezer.
- Clean the rear of the refrigerator regularly.
Dust increases energy consumption.
- Do not set temperature colder than necessary.
- Ensure sufficient air exhaust at the refrigerator base and at the back wall of the refrigerator.
Do not cover air vent openings.
- Allow clearance to the right, left, back and top when installing.
This will help reduce power consumption and keep your energy bills lower.

Contents

SETTING UP YOUR REFRIGERATOR	07
OPERATING YOUR REFRIGERATOR	11
TROUBLESHOOTING	15

setting up your refrigerator

GETTING READY TO INSTALL THE REFRIGERATOR

Congratulations on the purchase of your Samsung Refrigerator.

We hope you will enjoy the many state-of-the-art features and efficiencies that this new appliance has to offer.

- This refrigerator must be properly installed and located in accordance with the manual before it is used.
- Use this appliance only for its intended purpose as described in this instruction manual.
- We strongly recommend that any servicing be performed by a qualified individual.
- Please dispose of the packaging material for this product in an environmentally friendly manner.



- Pull the power plug out of the socket before changing the interior light of the refrigerator.
- Otherwise, there is a risk of electric shock.

Selecting the best location for the refrigerator

- Select a location without direct exposure to sunlight.
- Select a location with level (or nearly level) flooring.
- Select a location with enough space for the refrigerator doors to open easily.
- Allow sufficient space to install the refrigerator on a flat surface.
- If your refrigerator is not level, the internal cooling system may not work correctly.
- Overall space required in use. Refer to drawing and dimension as below.

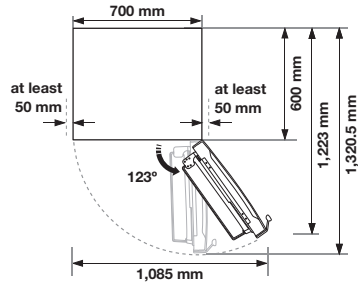
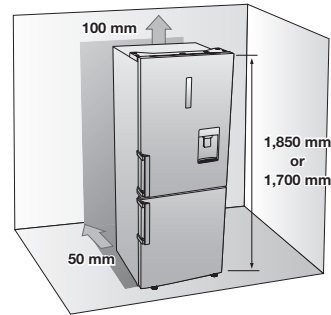

- Allow sufficient space to the right, left, back and top for air circulation. This will help reduce power consumption and keep your energy bills lower.
- Do not install the refrigerator where the temperature will go below 10 °C.
- Please ensure that appliance can be moved freely in the event of maintenance & service.



When installing, servicing, or cleaning behind the refrigerator, be sure to pull the unit straight out and push back in straight after finishing. Also, make sure your floor supports the full-load refrigerator. Otherwise, it may cause floor damage.



Please tie up the extra length of the power cord at the back of the refrigerator so as not to be touched on the floor preventing the power cord from being crushed by the rollers upon relocation.

LEVELLING THE REFRIGERATOR

If the front of the appliance is slightly higher than the rear, the door can be opened and closed more easily.

Case 1) The appliance tilts down to the left.
Turn the left adjusting leg in the direction of the arrow until the appliance is level.

Case 2) The appliance tilts down to the right.
Turn the right adjusting leg in the direction of the arrow until the appliance is level.

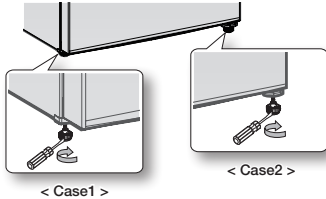

SETTING UP THE REFRIGERATOR

Now that you have your new refrigerator installed and in place, you are ready to set up and enjoy the full features and functions of the appliance. By completing the following steps, your refrigerator should be fully operational.

If not, first check the power supply and electricity source or try the troubleshooting section at the back of this user guide.

If you have any further questions, contact your Samsung Electronics service center.

- Place the refrigerator in an appropriate location with reasonable clearance between the wall and the refrigerator.
Refer to installation instructions in this manual.
- Once the refrigerator is plugged in, make sure the interior light comes on when you open the doors.
- Set the temperature control to the coldest temperature and wait for an hour.
The freezer should get slightly chilled and the motor should run smoothly.
- After powering the refrigerator, it will take a few hours to reach the appropriate temperature. Once the refrigerator temperature is sufficiently cool, you can store food and drink in the refrigerator.

REVERSING THE DOOR (RL4003RBA**, RL4013J(S)BA**, RL4323**, RL4353**, RL4352**, ONLY)

Before you reverse the refrigerator door, make sure to unplug the refrigerator. Samsung recommends that reversing of the door opening is only completed by Samsung approved Service providers. This will be on a chargeable basis and at the customers expense.



Any damage caused while attempting to reverse the door opening is not covered under the appliance manufactures warranty.

Any repairs requested due to this circumstance will be completed on a chargeable basis at the customers expense.

- Before attempting to reverse the refrigerator doors ensure that the refrigerator is disconnected from the main electricity supply and all food stuffs are emptied from inside the appliance.
- If the customer does not feel confident to follow instruction in the user manual, a Samsung qualified service engineer must be contacted to carry out this change.
- Do not plug in Refrigerator just after door reverse finished process and wait for at least one hour.

Required Tools

Not provided		
Phillips Head Driver (+)	Flat Head Driver (-)	10 mm Socket Wrench (for bolts)
Not provided	Additional part	
11 mm Wrench (for hinge shaft)	3/16 " Allen Wrench (for middle hinge)	Top Left Hinge Cover (Underneath the Top Cover)

1. Remove the Hinge Cover and detach the sensor from the right Hinge Cover.

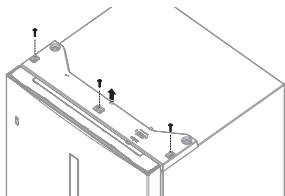

2. Remove bolts (1) and disconnect the wire (2).

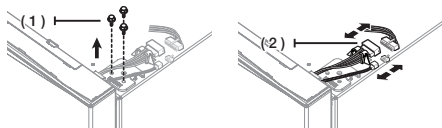

3. Remove Door Cover (1).

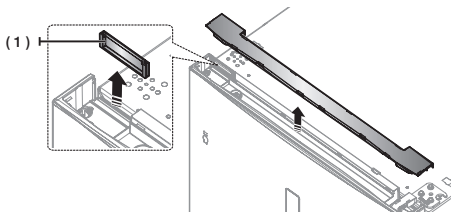

4. Remove the Hinge and detach Hinge Case from the hinge. Pull the wires out from the Hinge Case. (Door display type only)

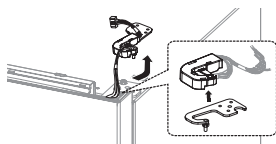

5. Remove the fridge door from the Middle hinge by carefully lifting the door straight up.

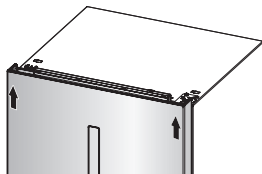

The door is heavy, be careful not to injure yourself when removing the door.

6. Disassemble the Middle hinge.

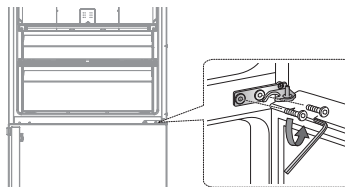

7. Remove the freezer door from the Bottom hinge by carefully lifting the door straight up.

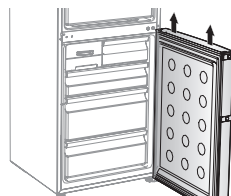

The door is heavy, be careful not to injure yourself when removing the door.

8. Lay the refrigerator carefully. Switch the position of Bottom Hinge and Leg.

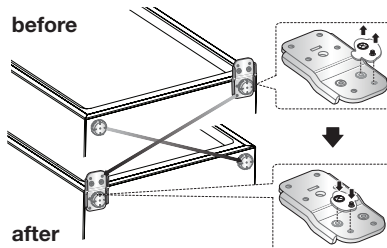

9. Remove the screw on the bottom right side of the fridge and freezer door. Switch Door Stopper (1), Grommet (2) and Bracket (3) from the right to the left.

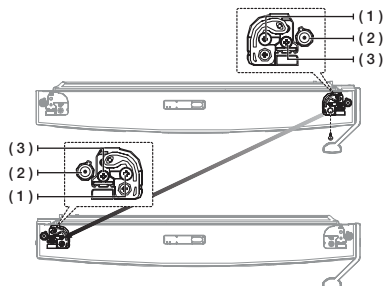

10. Switch the position of Grommet and Cap screws.

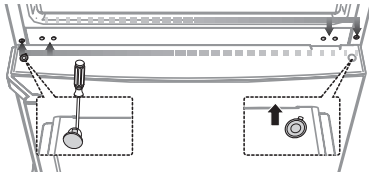

Be careful not to injure yourself during operation.

11. Carefully put the freezer door back on.
Assemble the Middle hinge.

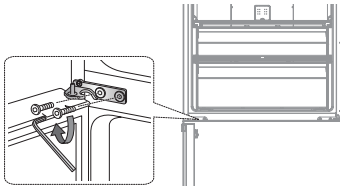

12. Switch the Wire door direction to opposite side on fridge door. (Door display type only)

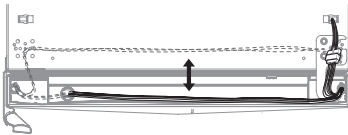

13. Use 11 mm wrench to separate the Top hinge shaft. Flip the Top hinge and reattach the Top hinge shaft.

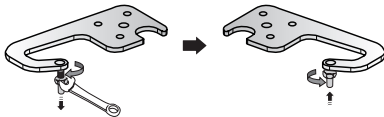

14. Carefully put the Fridge door back on and assemble the hinge.

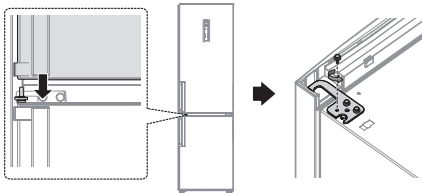

15. Change the Wire door direction to opposite side and assemble the door cover.

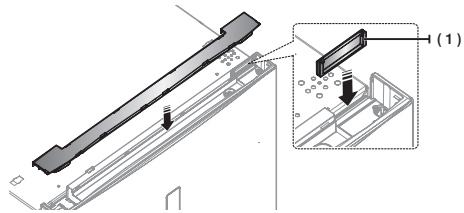

16. Connect wires (Door display type only) and Assemble the Hinge Cover.

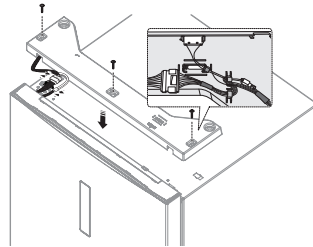

Be careful not to damage on wires when reversing the door.

17. Switch the handles from the left to the right.



- When disassemble the Cover slider door, carefully open with both hands and pull it out. (Ez handle model only)

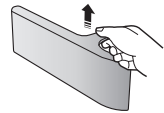

- There is a risk of broken.

18. Detach the Fridge and the Freezer door gaskets and then attach them after rotating them 180°.

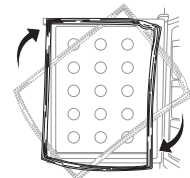

operating your refrigerator

USING THE CONTROL PANEL

TYPE A

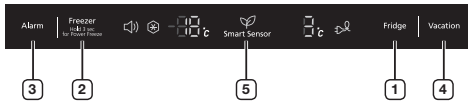

Each time you press the button, a short beep will sound.

1 Fridge

Press the Fridge button to set the fridge to desired temperature from the range between 1 °C and 7 °C.

Default set temperature is set on 3 °C and each time you press the Fridge button, temperature will change in following order and temperature indicator will display the desired temperature.

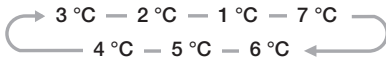

2 Freezer

Press the Freezer button to set the freezer to desired temperature from the range between -15 °C and -23 °C.

Default set temperature is set on -19 °C and each time you press the Freezer button, temperature will change in following order and temperature indicator will display the desired temperature.

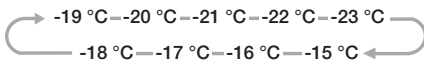

TYPE B

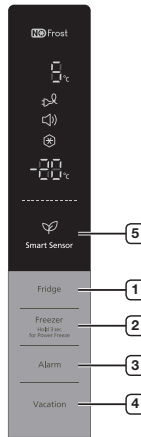

Fridge or Freezer temp indicator will blink when temperature in the fridge or freezer compartment goes up dramatically by storing warm food or frequent door opening.

Fridge or Freezer temperature indicator will stop blinking when temperature in the fridge or freezer becomes normal. If temperature indicator does not stop blinking after several hours, please contact your service center.

Press this button for 3 seconds to activate the Power Freeze function.

Power Freeze indicator () will light up and the refrigerator will speed up the time to needed to freeze products in the freezer.

This function will be activated for 50 hours and freezer indicator will display -23 °C.

This function switches off automatically.

When the Power Freeze process is completed, the Power freeze indicator switches off and the freezer switches back to the previous temperature setting. When you use this function, the energy consumption will increase.

To deactivate this function, press the Freezer button for 3 seconds.



If you need to freeze large amount of food stuff, activate Power Freeze function 20 hours before.

3 Alarm

Press this button to activate the Alarm function. Alarm indicator () will light up and the refrigerator will alert you with alarm sound if the refrigerator door is kept open for longer than 2 minutes.

To deactivate the Alarm function, press this button.

4 Vacation

Press the Vacation button to activate the Vacation function.

Vacation indicator () will light up and the refrigerator will set the temperature to 15 °C to minimize the power consumption when you are going on a long vacation or business trip or you do not need to use the refrigerator.

While Vacation function is activated, freezer compartment remains on.

Vacation function will be automatically deactivated if you adjust fridge temperature while Vacation function is on.

Make sure to remove foods in the fridge compartment before using Vacation function.

5 Smart Sensor

This icon () will light up when the refrigerator is activated with the optimized energy efficiency. (TYPE B Only)

Without additional controls, it keeps food freshness automatically by many sensors detecting the inner and outside temperature and minimizes energy consumption.

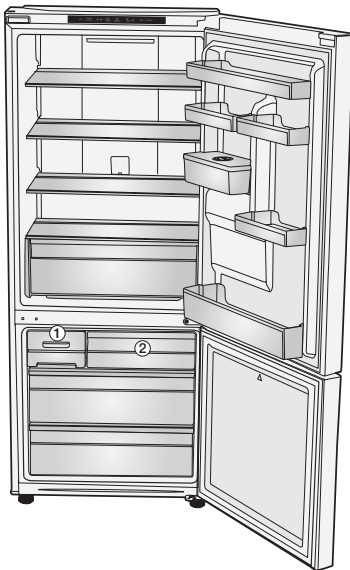

RL40*, (H : 1,700 mm)

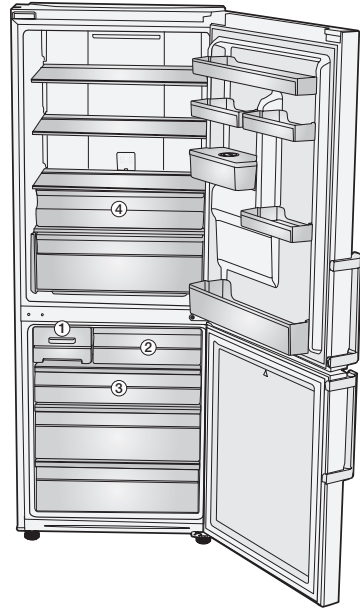

RL43*, (H : 1,850 mm)



- To get the best energy efficiency of this product, please leave all selves, drawers and baskets on their original position like as above illustration.
- Some of the feature such as Water tank and Fresh Room (4) can be different and may not be available depending on the model.
- The fruits or the vegetables could get frozen in Fresh Room. (Optional)

ADDITIONAL SHELF (OPTIONAL)



To get more space in the freezer, you can remove Ice Maker (1), mini drawer (2) and drawer (3) (RL43 model only), then place the additional shelf (Optional) just above the bottom drawer.

It does not affect thermal and mechanical characteristics.

A declared storage volume of the freezer compartment is calculated with these parts removed.



MAKING ICE

TWIST ICE MAKER

- Making Ice Cubes

Remove the ice cube tray by lifting up slightly and pulling it towards you.

Fill the tray with water up to the maximum water level marked on the rear of the tray.

Slide the tray back into the holder, taking care not to spill the water.

Wait until the ice cubes are formed.

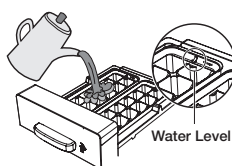

- Removing the Ice Cubes

Make sure that the ice cube storage bin is in place under the ice cube tray.

If not, slide it into place.

Twist the lever firmly in the clockwise direction until the tray twists slightly.

Result : The ice cubes fall into the storage bin.

Remove the storage bin by:

- Lifting it slightly
- Pulling it towards you



USING THE FOLDABLE SHELF (OPTIONAL)

You can fold the foldable shelf if you need to accommodate taller containers or products on the shelf underneath.

1. Slightly lift up the shelf and slide it inward.
2. Lift up the tucked shelf towards the rear wall.
3. You can simply pull the folded shelf in reverse procedure to use the fully extended shelf.

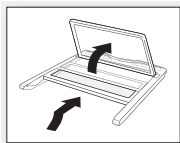

Shelf can fall out, handle with care when using or cleaning the shelf.

When you fold the Foldable shelf, make enough space to lift up foldable shelf.



Do not lift up rear part of Folder shelf.

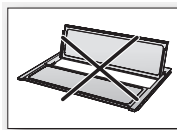

USING THE WATER DISPENSER (OPTIONAL)

With the water dispenser, you can obtain chilled water easily without opening the refrigerator door.

- Lift up and pull out the water tank.
 - Hold the handgrips on both sides to lift out the water tank.
 - Clean the inside of water tank before using it for the first time.



For more space, empty the water off the water tank, remove the lid completely, place the water tank back and use it to store food.

For water dispenser usage, do not put anything other than water in the water tank.

- Fill the water tank with water, ensuring that it is in a stable position, allowing for the extended water supply outlet.
 - Fill with water up to 2.4 L. If it is filled higher than this, it may overflow when the lid is closed.
 - It is impossible to fill the tank with water while it is positioned in the refrigerator.
- Method 1.
 - Fill the water lifting the round lid in the arrow direction to open.

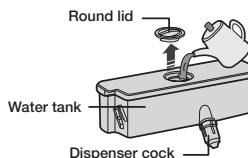

- Method 2.
 - Please fill the water after holding and lifting the large lid to open it.

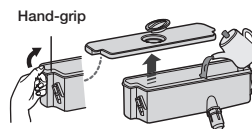

- Close the refrigerator door after fitting the water tank.
- Confirm that the dispenser cock is outside after closing the door.



Fix water tank to the fridge door tightly. If not, water tank may not be operate correctly. Do not use the refrigerator without the water tank. If not, it may cause an efficiency problem.



- Place a glass underneath the water outlet and push gently against the dispenser lever with your glass. Make sure the glass is in line with the dispenser to prevent the water from bouncing out.



Check that the locking device is set to "unlock". Water can only be dispensed on this setting.

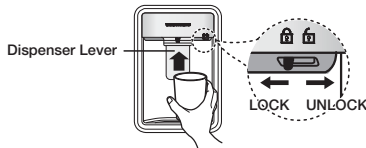

Water tank

Firmly grab the water tank with both hands and lift it up towards you gently to remove the water tanks.



Water tank may not be available depending on the model.

Drawers

Pull the drawers out fully then slightly lift it up to remove the drawers.

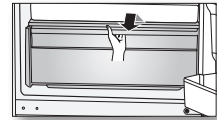

- If the drawers get stuck to door, remove drawer by lifting up after remove shelves.

Freezer Rail Drawer (Optional)

Lift up the Rail Drawer until take off from the hook then pull the drawer out.



- When put back the Rail Drawer, tuck the rail then place the Rail Drawer to the original position.



- Do not touch Steel Rail in the freezer with wet hands.
 - This may cause frostbite.
- Be careful when you touch the Steel Rail.
 - This may cause a personal injury.

REMOVING THE INTERIOR PARTS

Shelves

Gently lift up the shelves with both hands and pull it toward you. (Glass shelf/ Foldable shelf)

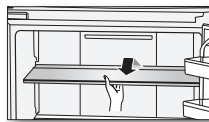

Do not put the shelves upside down or backwards. There is a risk of falling.

Door guards

Firmly grab the door guards with both hands and lift it up gently to remove the door guards.

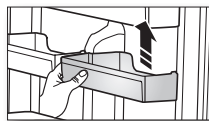

CLEANING THE REFRIGERATOR



Do not use Benzene, Thinner or Clorox™ for cleaning. They may damage the surface of the appliance and can create a risk of fire.



Do not spray the refrigerator with water while it is plugged in, as it may cause an electric shock. Do not clean the refrigerator with benzene, thinner or car detergent for risk of fire.

REPLACING THE LED LAMP

When the interior or exterior LED lamp has gone out, do not disassemble the lamp cover and LED lamp by yourself.



Please contact your service agents.

troubleshooting

PROBLEM	SOLUTION
The appliance is not operating at all or the temperature is too high.	<ul style="list-style-type: none"> • Check if the power plug is correctly connected. • Is the temperature control on the front panel correctly set? • Does sun shine on the appliance or are there any heat sources nearby? • Is the back of the appliance too close to the wall?
The food in the refrigerator is frozen.	<ul style="list-style-type: none"> • Is the temperature control on the front panel set to the coldest temperature? • Is the surrounding temperature too low?
There are unusual noises.	<ul style="list-style-type: none"> • Check if the appliance is installed on a stable and even floor. • Is the back of the appliance too close to the wall? • Have any foreign objects fallen behind or under the appliance? • Is the noise coming from the compressor in the appliance? • A ticking sound occurs when the various accessories contract or expand.
The front corners and sides of the appliance are warm and condensation starts to form.	<ul style="list-style-type: none"> • Heat-proof pipes are installed in the front corners of the appliance to prevent condensation from forming. When the surrounding temperature rises, this may not always be effective. However, this is not abnormal. • In very humid weather, condensation may form on the outer surface of the appliance when the moisture in the air comes into contact with the cool surface of the appliance.
You can hear a liquid bubbling in the appliance.	<ul style="list-style-type: none"> • This is the refrigerant, which cools the inside of the appliance.
There is a bad smell inside the appliance.	<ul style="list-style-type: none"> • Is there any spoiled food inside of the refrigerator? • Make sure that strong smelling food (for example, fish) is wrapped so that it is airtight. • Clean out your refrigerator periodically and throw away any spoiled or suspect food.
There is a layer of frost on the appliances walls.	<ul style="list-style-type: none"> • Are the air outlet vents blocked by food stored inside the refrigerator? • Space the food out as much as possible to improve ventilation. • Is the door fully closed?
Condensation forms on the inside wall of the appliance and around vegetables.	<ul style="list-style-type: none"> • Food with a high water content is stored uncovered with a high humidity level or the door has been left open for a long time. • Store the food with a cover or in sealed containers.

Ambient Room Temperature Limits

This fridge/freezer is designed to operate in ambient temperatures specified by its temperature class marked on the rating plate.

Class	Symbol	Ambient Temperature range (°C)
Extended Temperate	SN	+10 to +32
Temperate	N	+16 to +32
Subtropical	ST	+16 to +38
Tropical	T	+16 to +43



Internal temperatures may be affected by such factors as the location of the fridge/freezer, ambient temperature and the frequency with which you open the door. Adjust the temperature as required to compensate for these factors.

Correct Disposal of This Product (Waste Electrical & Electronic Equipment)

English



(Applicable in countries with separate collection systems)

This marking on the product, accessories or literature indicates that the product and its electronic accessories (e.g. charger, headset, USB cable) should not be disposed of with other household waste at the end of their working life. To prevent possible harm to the environment or human health from uncontrolled waste disposal, please separate these items from other types of waste and recycle them responsibly to promote the sustainable reuse of material resources.

Household users should contact either the retailer where they purchased this product, or their local government office, for details of where and how they can take these items for environmentally safe recycling.

Business users should contact their supplier and check the terms and conditions of the purchase contract. This product and its electronic accessories should not be mixed with other commercial wastes for disposal.

Contact SAMSUNG WORLD WIDE

If you have any questions or comments relating to Samsung products, please contact the SAMSUNG customer care center.

COUNTRY	CALL	WEB SITE
AUSTRALIA	1300 362 603	www.samsung.com
COLOMBIA	01-8000112112	www.samsung.com
EIRE	0818 717100	www.samsung.com
HONG KONG	(852) 3698-4698	www.samsung.com/hk www.samsung.com/hk_en/
INDIA	1800 1100 11 3030 8282 1800 3000 8282 1800 266 8282	www.samsung.com
MALAYSIA	1800-88-9999	www.samsung.com
NEW ZEALAND	0800 SAMSUNG (0800 726 786)	www.samsung.com
PANAMA	800-7267	www.samsung.com
PHILIPPINES	1-800-10-SAMSUNG(726-7864) for PLDT 1-800-3-SAMSUNG(726-7864) for Digital 1-800-8-SAMSUNG(726-7864) for Globe 02-5805777	www.samsung.com
SINGAPORE	1800-SAMSUNG (726-7864)	www.samsung.com
SOUTH AFRICA	0860-SAMSUNG (726-7864)	www.samsung.com
U.K	0330 SAMSUNG (7267864)	www.samsung.com
VIETNAM	1 800 588 889	www.samsung.com