

SAMSUNG

HW-K650

HW-K651

User manual

Imagine the possibilities

Thank you for purchasing this Samsung product.





To receive more complete service, please register your product at





www.samsung.com/register

SAFETY INFORMATION

SAFETY WARNINGS

TO REDUCE THE RISK OF ELECTRIC SHOCK, DO NOT REMOVE THE COVER (OR BACK).
NO USER-SERVICEABLE PARTS ARE INSIDE. REFER SERVICING TO QUALIFIED SERVICE PERSONNEL.

 <div style="background-color: black; color: white; padding: 5px; text-align: center; width: fit-content; margin: 0 auto;"> CAUTION RISK OF ELECTRIC SHOCK. DO NOT OPEN. </div> 	 This symbol indicates that high voltage is present inside. It is dangerous to make any kind of contact with any internal part of this product.
	 This symbol indicates that important literature concerning operation and maintenance has been included with this product.

	Class II product : This symbol indicates that it does not require a safety connection to electrical earth (ground).
	AC voltage : This symbol indicates that the rated voltage marked with the symbol is AC voltage.
	DC voltage : This symbol indicates that the rated voltage marked with the symbol is DC voltage.
	Caution, Consult instructions for use : This symbol instructs the user to consult the user manual for further safety related information.

WARNING : To reduce the risk of fire or electric shock, do not expose this appliance to rain or moisture.

CAUTION : TO PREVENT ELECTRIC SHOCK, MATCH WIDE BLADE OF PLUG TO WIDE SLOT, FULLY INSERT.

- This apparatus shall always be connected to a AC outlet with a protective grounding connection.
- To disconnect the apparatus from the mains, the plug must be pulled out from the mains socket, therefore the mains plug shall be readily operable.

CAUTION

- Do not expose this apparatus to dripping or splashing. Do not put objects filled with liquids, such as vases on the apparatus.
- To turn this apparatus off completely, you must pull the power plug out of the wall socket. Consequently, the power plug must be easily and readily accessible at all times.

Wiring the Main Power Supply Plug (UK Only)

IMPORTANT NOTICE

The mains lead on this equipment is supplied with a moulded plug incorporating a fuse. The value of the fuse is indicated on the pin face of the plug and if it requires replacing, a fuse approved to BS1362 of the same rating must be used. Never use the plug with the fuse cover removed. If the cover is detachable and a replacement is required, it must be of the same colour as the fuse fitted in the plug. Replacement covers are available from your dealer. If the fitted plug is not suitable for the power points in your house or the cable is not long enough to reach a power point, you should obtain a suitable safety approved extension lead or consult your dealer for assistance. However, if there is no alternative to cutting off the plug, remove the fuse and then safely dispose of the plug. Do not connect the plug to a mains socket as there is a risk of shock hazard from the bared flexible cord. Never attempt to insert bare wires directly into a mains socket. A plug and fuse must be used at all times.

IMPORTANT

The wires in the mains lead are coloured in accordance with the following code:- BLUE = NEUTRAL BROWN = LIVE
As these colours may not correspond to the coloured markings identifying the terminals in your plug, proceed as follows:- The wire coloured BLUE must be connected to the terminal marked with the letter N or coloured BLUE or BLACK. The wire coloured BROWN must be connected to the terminal marked with the letter L or coloured BROWN or RED.

WARNING : DO NOT CONNECT EITHER WIRE TO THE EARTH TERMINAL WHICH IS MARKED WITH THE LETTER E OR BY THE EARTH SYMBOL , OR COLOURED GREEN OR GREEN AND YELLOW.

PRECAUTIONS

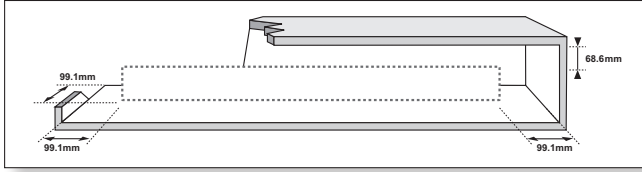

Ensure that the AC power supply in your house complies with the power requirements listed on the identification sticker located on the back of your product. Install your product horizontally, on a suitable base (furniture), with enough space around it for ventilation (7~10 cm). Make sure the ventilation slots are not covered. Do not place the unit on amplifiers or other equipment which may become hot. This unit is designed for continuous use. To fully turn off the unit, disconnect the AC plug from the wall outlet. Unplug the unit if you intend to leave it unused for a long period of time.

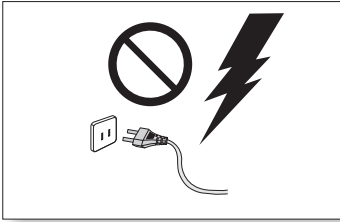

During thunderstorms, disconnect the AC plug from the wall outlet. Voltage peaks due to lightning could damage the unit.

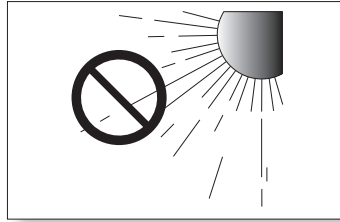

Do not expose the unit to direct sunlight or other heat sources. This could lead to overheating and cause the unit to malfunction.

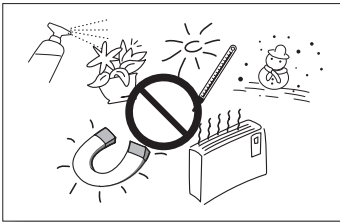

Protect the product from moisture (i.e. vases), and excess heat (e.g. a fireplace) or equipment creating strong magnetic or electric fields. Disconnect the power cable from the AC supply if the unit malfunctions. Your product is not intended for industrial use. It is for personal use only. Condensation may occur if your product has been stored in cold temperatures. If transporting the unit during the winter, wait approximately 2 hours until the unit has reached room temperature before using.

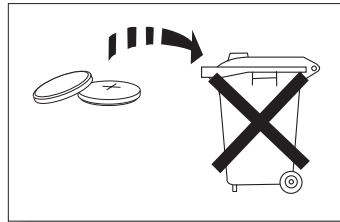

The batteries used with this product contain chemicals that are harmful to the environment. Do not dispose of batteries in the general household trash. Do not dispose of batteries in a fire. Do not short circuit, disassemble, or overheat the batteries. There is a danger of explosion if the battery is incorrectly replaced. Replace only with the same or equivalent type.



WARNING: DO NOT INGEST BATTERY. CHEMICAL BURN HAZARD. The remote control supplied with this product contains a coin/button cell battery. If the coin/button cell battery is swallowed, it can cause severe internal burns in just 2 hours and can lead to death. Keep new and used batteries away from children. If the battery compartment does not close securely, stop using the product and keep it away from children. If you think batteries might have been swallowed or placed inside any part of the body, seek immediate medical attention.

CONTENTS

2 GETTING STARTED

- 2 Safety Information
- 5 What's Included

6 DESCRIPTIONS

- 6 Front / Right Side Panel
- 7 Rear / Bottom Panel
- 8 Remote Control

11 INSTALLATION

- 11 Installing the Soundbar
 - 11 Installing the Wall Mount
 - 15 Detaching the Soundbar from the Wall

16 CONNECTIONS

- 16 Connecting the Subwoofer
- 18 Connecting to a TV
 - 18 TV SoundConnect
 - 19 Connecting to a TV Using an HDMI (Digital) Cable
 - 20 Connecting to a TV Using a Digital Optical Cable
- 21 Connecting to External Devices
 - 21 HDMI Cable
 - 22 Optical or Analogue Audio Cable

23 FUNCTIONS

- 23 Input Mode
- 24 Bluetooth
- 27 Using the Multiroom App
- 29 Using the Network Standby On Function
- 30 Software Update

32 TROUBLESHOOTING

- 32 Troubleshooting

33 APPENDIX

33 Specifications



- Figures and illustrations in this User Manual are provided for reference only and may differ from actual product appearance.
- An administration fee may be charged if either
 - (a) an engineer is called out at your request and there is no defect with the product (i.e. where the user manual has not been read).
 - (b) you bring the unit to a repair centre and there is no defect with the product (i.e. where the user manual has not been read).
- You will be informed of the administration fee amount before a technician visits.

WHAT'S INCLUDED

BEFORE READING THE USER'S MANUAL

Note the following terms before reading the user manual.

► Icons used in this manual

Icon	Term	Definition
	Caution	Indicates a situation where a function does not operate or settings may be cancelled.
	Note	Indicates tips or instructions on the page that help you operate a function.

Check for the supplied accessories shown below.

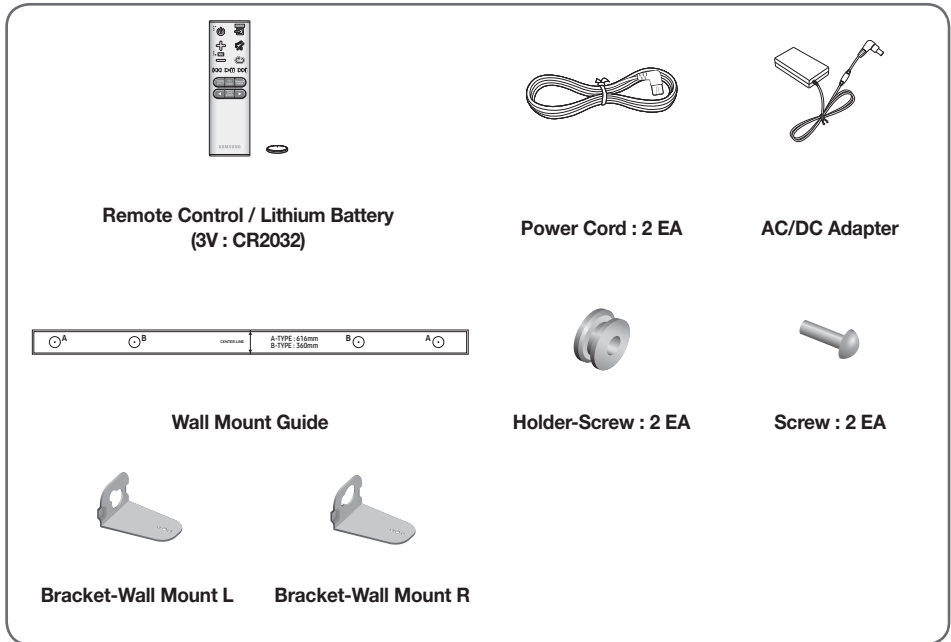

- The appearance of the accessories may differ slightly from the illustrations above.
- Micro USB to USB adapter and HDMI cables are sold separately. To purchase, contact a Samsung Service Centre or Samsung Customer Care.

FRONT / RIGHT SIDE PANEL



1 + / - (Volume) Button

Controls the volume level.

The numeric value of the volume level appears in the front panel display.

2 ↵ (Source) Button

Selects the D.IN, AUX, HDMI, BT, or TV input.

- While the unit is powered on, pressing the ↵ button for more than 3 seconds sets the button to act as the  (Mute) button. To cancel the  (Mute) button setup, press the ↵ button for more than 3 seconds again.

3 (Power) Button

Turns the power on and off.

Right Side

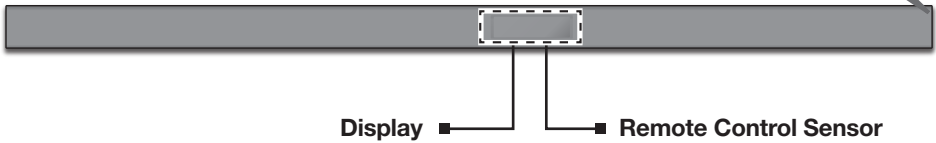
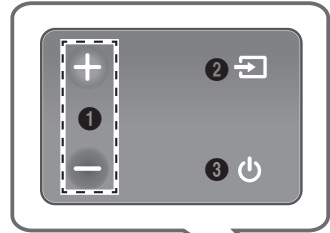

Displays the current mode.



- When you plug in the AC cord, the power button will begin working in 4 to 6 seconds.
- When you turn on this unit, there will be a 4 to 5 second delay before it produces sound.
- If you want to enjoy sound only from the Soundbar, you must turn off the TV's speakers in the Audio Setup menu of your TV. Refer to the owner's manual supplied with your TV.

REAR / BOTTOM PANEL

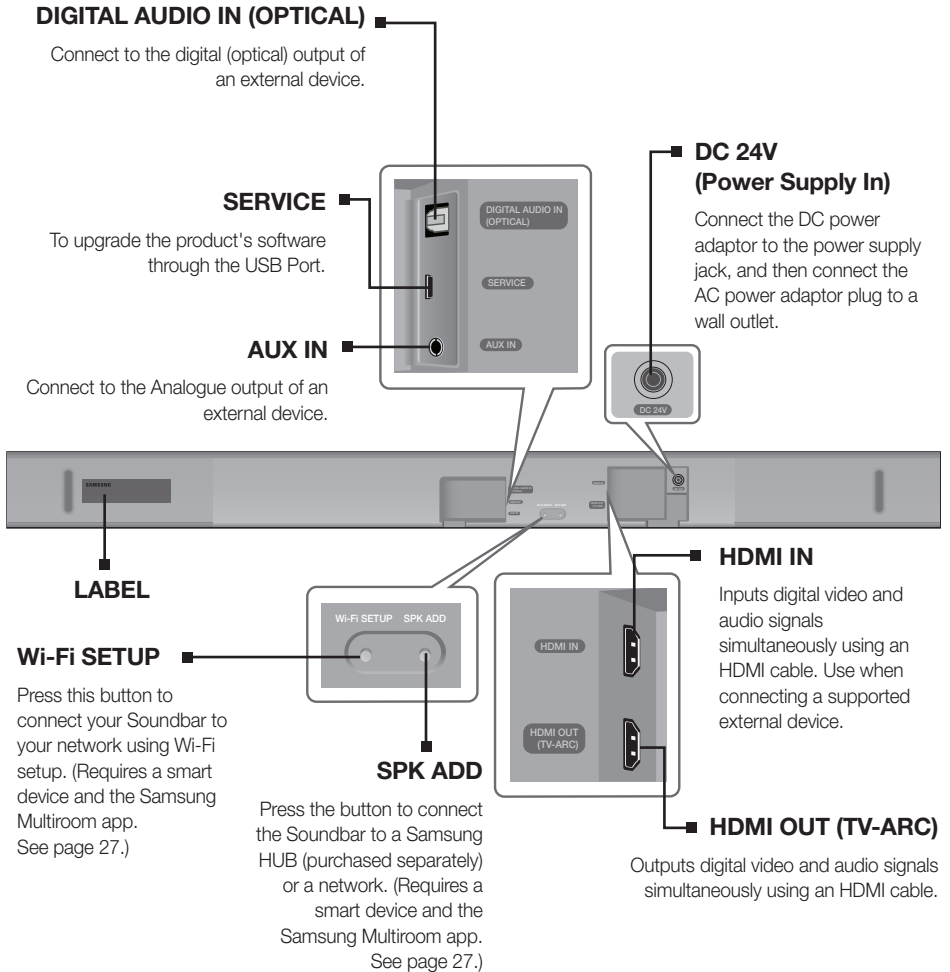

- When disconnecting the power cable of the AC power adaptor from a wall outlet, pull the plug. Do not pull the cable.
- Do not connect this unit or other components to an AC outlet until all connections between components are complete.
- Make sure to rest the AC/DC Adapter flat on a table or the floor. If you place the AC/DC Adapter so that it is hanging with the AC cord input facing upwards, water or other foreign substances could enter the Adapter and cause the Adapter to malfunction.

REMOTE CONTROL

SOURCE
Press to select a source connected to the Soundbar.

Mute
You can turn the volume down to 0 with the push of a button. Press again to restore the sound to the previous volume level.

Repeat
The Repeat function is available only when playing back music from Songs on phone or DMS of Samsung Multiroom app.
OFF - REPEAT : Cancels Repeat Playback.
TRACK - REPEAT : Plays a track repeatedly.
ALL - REPEAT : Plays all tracks repeatedly.

Skip Forward
If there is more than one file on the device you are playing, and you press the ►► button, the next file is selected.

Bluetooth POWER
Press the **Bluetooth POWER** button on the remote to turn the Bluetooth POWER On function on and off. See pages 19 and 25 for details.

(o) SOUND
Surround Sound adds depth and spaciousness to the sound. Pressing the (o) **SOUND** button repeatedly cycles through the Surround Sound settings :
ON - SURROUND SOUND, OFF - SURROUND SOUND

Press and hold the ► button for about 5 seconds to turn the Anynet+ function on or off.
OFF - ANYNET+, ON - ANYNET+
The Anynet+ function lets you control the Soundbar with the remote from an Anynet+ compatible Samsung TV.
The Soundbar must be connected to the TV via an HDMI cable.

Press and hold the ◀ button for about 5 seconds to turn the Auto Power Link function on or off.
OFF - POWER LINK, ON - POWER LINK
* Auto Power Link
Synchronizes the Soundbar to a connected Optical source via the Optical jack so it turns on automatically when you turn on your TV. (See page 20)
Auto Power Link function is only available in the **D.IN** mode.

SOUND EFFECT
You can select from 6 sound modes - **STANDARD (Original Sound), MUSIC, CLEAR VOICE, SPORTS, MOVIE,** and **NIGHT** - depending on the content you want to listen to.
Select the **STANDARD** mode if you want to enjoy the original sound.
* **DRC (Dynamic Range Control)**
Lets you apply dynamic range control to Dolby Digital.
Press and hold the **SOUND EFFECT** button for about 5 seconds in **STANDBY** mode to turn the DRC (Dynamic Range Control) function on or off.

Power
Turns the Soundbar on and off.

Volume
Adjusts the volume level of the unit.

Play / Pause
Press the **▶||** button to pause a file temporarily.
Press the **▶||** button again to play the selected file.

Skip Back
If there is more than one file on the device you are playing, and you press the **◀◀** button, the previous file is selected.

SOUND CONTROL
Press to select **TREBLE**, **BASS**, **SUBWOOFER LEVEL** or **AUDIO SYNC**.
Then, use the **◀, ▶** buttons to adjust the **TREBLE** or **BASS** volume from -3 ~ +3, **SUBWOOFER LEVEL** volume from -12, -6 ~ +6.
Press and hold the **SOUND CONTROL** button for about 5 seconds to adjust the sound for each frequency band. 150Hz, 300Hz, 600Hz, 1.2KHz, 2.5KHz, 5KHz, and 10KHz are selectable and each can be adjusted to a setting between -6 ~ +6.
If the Soundbar is connected to a digital TV and the video appears out of sync with the audio, press the **SOUND CONTROL** button to sync the audio with the video. Use the **◀, ▶** buttons to set the audio delay between 0 ms ~ 300 ms. In TV mode, and BT mode, the Audio Sync function may not be available.



- Operate the TV using the TV's remote control.

► Controlling the Soundbar using Your TV Remote Control

1. Press and hold the (ⓘ) **SOUND** button for more than 5 seconds while the Soundbar is turned on.
2. "ON - TV REMOTE" appears on the Soundbar's display.
3. In the TV's menu, set the TV speaker to external speaker.



- Not available if the TV ARC function or **HDMI** mode is in use.
- All buttons are not available except the **VOL +/-** and the  buttons in this function.
- TV menus differ by manufacturer and model. Refer to the TV's user manual for further information.
- Manufacturers supporting this function:
 - VIZIO, LG, Sony, Sharp, PHILIPS, PANASONIC, TOSHIBA, GRUNDIG, Hisense, RCA
 - This function may not be compatible with your TV's remote depending on the remote control's manufacturer.
- To turn off this function, press the (ⓘ) **SOUND** button for 5 seconds. "OFF - TV REMOTE" appears on the Soundbar's display.

INSTALLING THE BATTERY IN THE REMOTE CONTROL

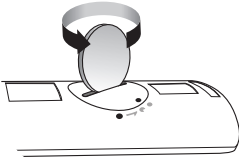

1. Use a suitable coin to turn the remote control's battery cover counterclockwise to remove it as shown in the figure above.

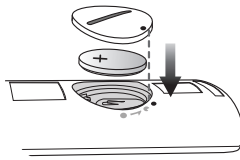

2. Insert a 3V lithium battery. Keep the positive (+) pole facing up when inserting the battery. Put the battery cover on and align the '•' marks side by side as shown in the figure above.

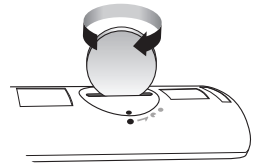

3. Use a suitable coin to turn the remote control battery cover clockwise as far as it will go to fix it in place.

INSTALLING THE SOUNDBAR

INSTALLING THE WALL MOUNT

► Installation Precautions

- Install on a vertical wall only.
- For the installation, avoid a location with high temperature or humidity, or a wall that cannot sustain the weight of the set.
- Check the strength of the wall. If the wall is not strong enough to support the unit, reinforce the wall or install the unit on a different wall that can support the unit's weight.
- Purchase and use the fixing screws or anchors appropriate for the kind of wall you have (plaster board, iron board, wood, etc.). If possible, fix the support screws into wall studs.
- Purchase wall mounting screws according to the type and thickness of the wall you will mount the Soundbar on.
 - Diameter: M5
 - Length: 35 mm or longer recommended.
- Connect cables from the unit to external devices before you install it on the wall.
- Make sure the unit is turned off and unplugged before you install it. Otherwise, it may cause an electric shock.

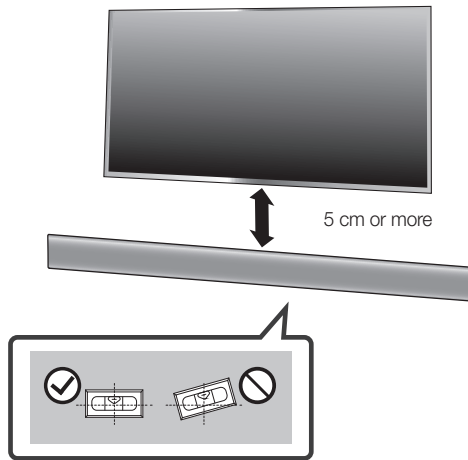

1. Place the **Wall Mount Guide** against the wall surface.
 - The **Wall Mount Guide** must be level.
 - If the TV is mounted on the wall, install the Soundbar at least 5 cm below the TV.

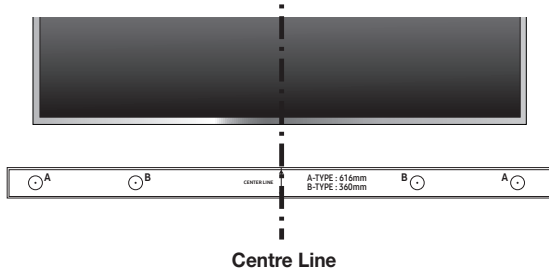

- Align the Paper Template's **Centre Line** with the centre of your TV (if you are mounting the Soundbar below your TV), and then fix the **Wall Mount Guide** to the wall using tape.



- If you are not mounting below a TV, place the **Centre Line** in the centre of the installation area.

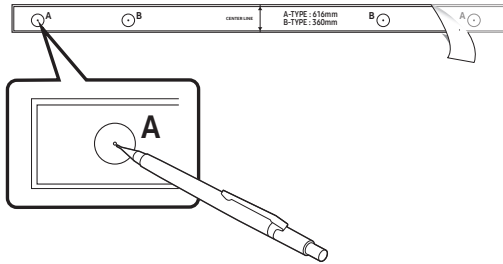

- Push a pen tip or sharpened pencil tip through the centre of the **A-TYPE** images on each end of the Guide to mark the holes for the supporting screws, and then remove the **Wall Mount Guide**.
- Using an appropriately sized drill bit, drill a hole in the wall at each marking.



- If the markings do not correspond to the positions of studs, make sure you insert appropriate anchors or mollies into the holes before you insert the support screws. If you use anchors or mollies, make sure the holes you drill are large enough for the anchors or mollies you use.

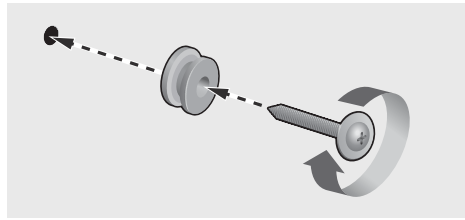

5. Push a screw (not supplied) through each **Holder-Screw**, and then screw each screw firmly into a support screw hole.

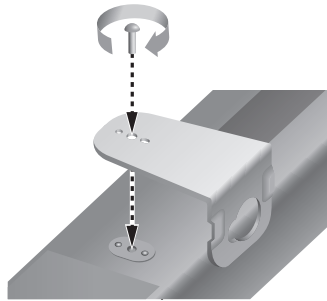

6. Use the two **Screws** (M4 x L12) to attach both **Bracket-Wall Mount L** and **R** to the Soundbar's bottom. For a proper fit, make sure to align the bumps on the Soundbar to the holes on the brackets.

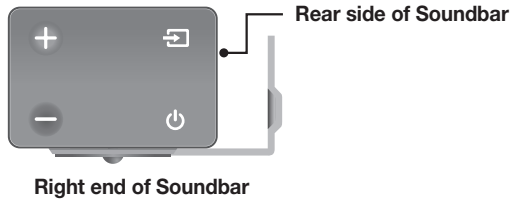

- When assembling, make sure the hanger part of **Bracket-Wall Mounts** faces backwards.



- The left and right mounts are different shapes. Make sure to position them correctly.

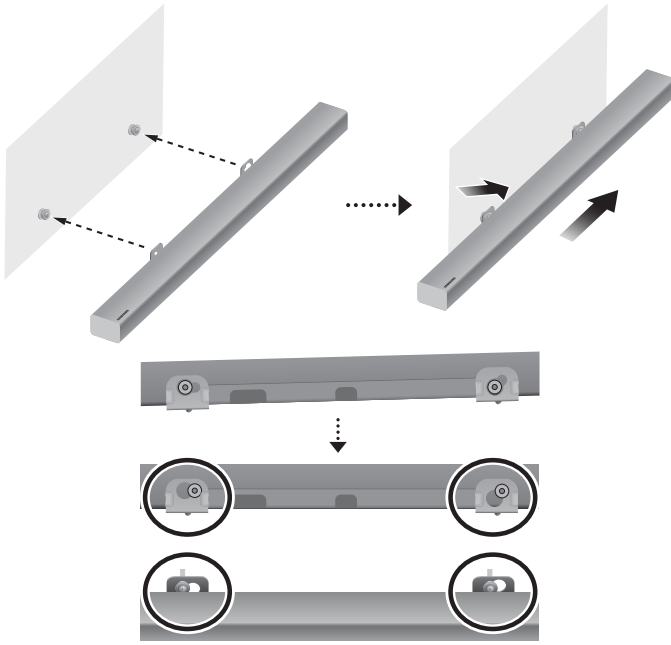

7. Install the Soundbar with the attached **Bracket-Wall Mounts** by hanging the **Bracket-Wall Mounts** on the **Holder-Screws** on the wall.



- Slightly tilt the Soundbar to insert both **Holder-Screw** heads into **Bracket-Wall Mount** holes. Push the Soundbar in the direction of the arrow to make sure both sides are firmly fixed.

DETACHING THE SOUNDBAR FROM THE WALL

1. To separate the Soundbar from the wall mount, push it in the direction of the arrow, and then pull it away from the wall as shown.

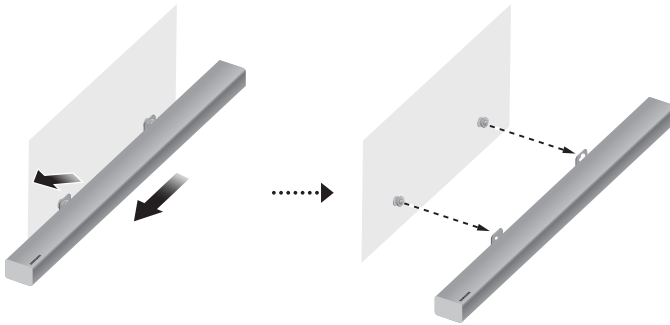

- Do not hang onto the installed unit and avoid striking or dropping the unit.
- Secure the unit firmly to the wall so that it does not fall off. If the unit falls off, it may cause an injury or damage the product.
- When the unit is installed on a wall, please make sure that children do not pull any of the connecting cables, as this may cause it to fall.
- For the optimal performance of a wall mount installation, install the speaker system at least 5 cm below the TV, if the TV is mounted on the wall.
- For your safety, if you do not mount the unit on the wall, install it on a secure, flat surface where it is unlikely to fall.



- Do not connect the power cord of this product or your TV to a wall outlet until all connections between components are complete.
- Before moving or installing this product, be sure to turn off the power and disconnect the power cord.

CONNECTING THE SUBWOOFER

CONNECTING TO THE SUBWOOFER AUTOMATICALLY

The Subwoofer's linking ID is preset at the factory and the main unit and subwoofer should link (connect wirelessly) automatically when the main unit and subwoofer are turned on.

- When the subwoofer is completely connected, the blue LED Link Indicator on the subwoofer stops blinking and glows continuously.

CONNECTING TO THE SUBWOOFER MANUALLY

If the blue LED light does not stop blinking when the main unit and subwoofer are turned on, please set the ID by following the steps below.



- Important: Before you begin, put the battery into the remote. See page 10 for instructions.

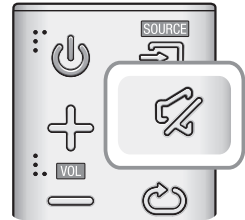
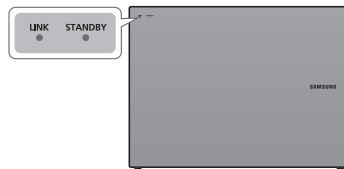
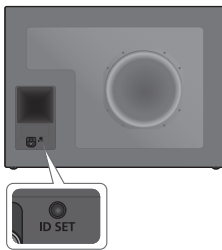

1. Plug the power cords of the main unit and subwoofer into an AC wall outlet.
2. Press the **ID SET** button on the back of the subwoofer with a small, pointed object for 5 seconds.
 - The STANDBY indicator turns off and the LINK indicator (Blue LED) blinks quickly.
3. While the main unit is powered off (in STANDBY mode), press and hold the  (Mute) on the remote control for 5 seconds.
4. The **ID SET** message appears on the Soundbar's display.
5. To finalise the link, turn the main unit's power on while the subwoofer's Blue LED blinks.
 - The main unit and the subwoofer should now be linked (connected).
 - The LINK indicator (Blue LED) on the subwoofer should be glowing continuously and not blinking.
 - If the LINK indicator is not solid blue, the linking process has failed. Turn off the main unit and start again from Step 2.
 - You can enjoy better sound from the wireless subwoofer by selecting a Sound Effect. (See page 8)



- Before moving or installing the product, be sure to turn off the power and disconnect the power cord.
- If the main unit is powered off, the wireless subwoofer will in standby mode and the STANDBY LED on the front will blink Red directly. (no blue LED).
- If you use a device that uses the same frequency (2.4GHz) as the Soundbar near the Soundbar, interference may cause some sound interruption.
- The maximum transmission distance of the wireless signal between the main unit and subwoofer is about 10 meters, but may vary depending on your operating environment. If a steel-concrete or metallic wall is between the main unit and the wireless subwoofer, the system may not operate at all, because the wireless signal cannot penetrate metal.
- If the main unit doesn't make a wireless connection, follow steps 1-5 on the previous page to re-set the connection between the main unit and wireless subwoofer.



- The wireless receiving antenna is built into the wireless subwoofer. Keep the unit away from water and moisture.
- For optimal listening performance, make sure that the area around the wireless subwoofer location is clear of any obstructions.

LED INDICATOR LAMP STATUS ON SUBWOOFER

LED	Status	Description	Resolution
Red	On	Standby (with the Soundbar main unit turned off)	Check the power supply to the Soundbar main unit
		Connection failed	Connect again (refer to the instructions on manual connection in the user manual)
Blue	On	Successfully connected (normal operation)	-
	Blinking	Standby (with the Soundbar main unit turned off)	Check the power supply to the Soundbar main unit
		Connection failed	Connect again (refer to the instructions on manual connection in the user manual)
Red and blue	Blinking	Malfunction	Contact the service center.

CONNECTING TO A TV



- Important: Before you begin, put the battery into the remote. See page 10 for instructions.

TV SOUNDCONNECT

You can enjoy TV sound through your Soundbar when it is connected to a Samsung TV that supports the TV SoundConnect function.



1. Turn on the TV and Soundbar.
2. Press the  button on the main unit's right side or the **SOURCE** button on the remote control to select the **TV** mode.
3. On the TV, a message asking whether to enable the TV SoundConnect function appears.
4. Select **<Yes>** using the TV's remote control to finish connecting the TV and Soundbar.



- If the TV SoundConnect linking process fails, navigate to SoundConnect in the TV's Sound menu, select **Add New Device**, and set **Add New Device** to **ON**. Then, try again.
- Switching the Soundbar's mode from TV to another mode automatically terminates TV SoundConnect.
- To connect the Soundbar to another TV, the existing connection must be terminated.
- To terminate the existing connection, press and hold the **▶||** button on the remote for 5 seconds or switch to another mode. To connect to the other TV, follow Steps 1 through 4 above.



- The TV SoundConnect (SoundShare) function is supported by some Samsung TVs released from 2012 on. Check whether your TV supports the TV SoundConnect (SoundShare) function before you begin. (For further information, refer to the TV's user manual.)
- If your Samsung TV was released before 2014, check the SoundShare setting menu.
- If the distance between the TV and Soundbar exceeds 10 meters, the connection may not be stable or the audio may stutter. If this occurs, relocate the TV or Soundbar so that they are within operational range, and then re-establish the TV SoundConnect connection.
- TV SoundConnect Operational Ranges:
 - Recommended pairing range: within 2 meters.
 - Recommended operational range: within 10 meters.
- The Play/Pause, Next, and Prev buttons on the Soundbar or Soundbar's remote do not control the TV.

► Using the Bluetooth POWER On function

The Bluetooth POWER On function is available after you have successfully connected the Soundbar to a Bluetooth compatible TV using TV SoundConnect. When the Bluetooth POWER On function is ON, turning the connected TV on or off will turn the Soundbar's power on and off as well.

1. Connect the TV to your Soundbar using the TV SoundConnect function.
2. Press the **Bluetooth POWER** button on the Soundbar remote. **ON - BLUETOOTH POWER** appears on the Soundbar's display.
 - **ON - BLUETOOTH POWER** : The Soundbar turns on and off when you turn the TV on or off.
 - **OFF - BLUETOOTH POWER** : The Soundbar only turns off when you turn the TV off.



- This function is supported by some Samsung TVs released from 2013 on.

CONNECTING TO A TV USING AN HDMI (DIGITAL) CABLE

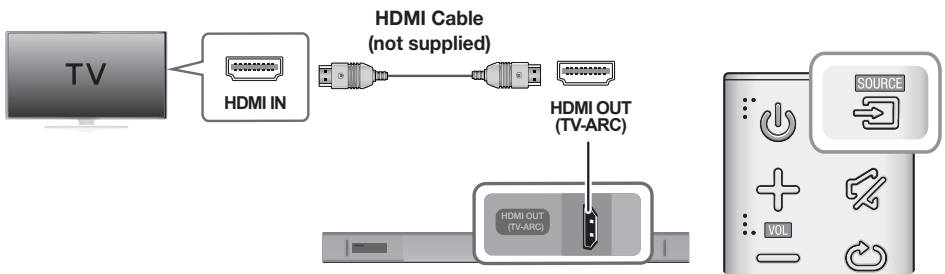



1. Connect an HDMI cable (not supplied) from the **HDMI OUT (TV-ARC)** jack on the bottom of the product to the HDMI IN jack on your TV.
2. Press the  button on the right side of the Soundbar or the **SOURCE** button on the remote control to select the **D.IN** mode.



- HDMI is an interface that enables the digital transmission of video and audio data with just a single connector.
- If the TV provides an ARC port, connect the HDMI cable to the HDMI IN (ARC) port.
- We recommend you use a coreless HDMI cable if possible. If you use a cored HDMI cable, use one whose diameter is less than 14 mm.
- Anynet+ must be turned on.
- This function is not available if the HDMI cable does not support ARC.

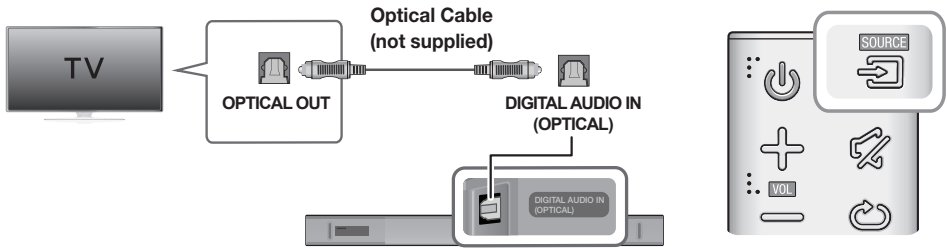

CONNECTING TO A TV USING A DIGITAL OPTICAL CABLE



1. Connect the **DIGITAL AUDIO IN (OPTICAL)** jack on the Soundbar to the **OPTICAL OUT** jack of the TV with a digital optical cable.
2. Press the  button on the right side of the Soundbar or the **SOURCE** button on the remote control to select the **D.IN** mode.

► Auto Power Link

If you have connected the main unit to a TV with a digital optical cable, you can set the Auto Power function ON to have the Soundbar turn on automatically when you turn the TV on.

1. Connect the Soundbar and a TV with a digital optical cable (not supplied).
2. Press the  button on the main unit's right side or the **SOURCE** button on the remote control to select the **D.IN** mode.
3. Press the  button on the remote control for 5 seconds to turn Auto Power Link on or off.



- Auto Power Link is set to ON by default.
- Depending on the connected device, Auto Power Link may not function.

CONNECTING TO EXTERNAL DEVICES

HDMI CABLE

HDMI is the standard digital interface for connecting to TVs, projectors, DVD players, Blu-ray players, set top boxes, and more.

HDMI prevents any degradation to the signal due to conversion to analogue and maintains the video and audio quality of the original digital source.

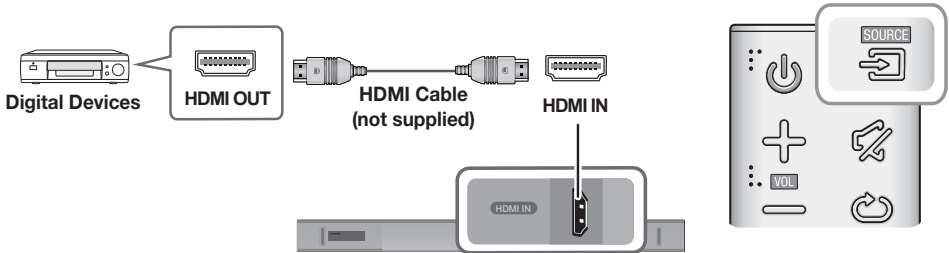

1. Connect an HDMI cable (not supplied) from the **HDMI IN** jack on the bottom of the product to the HDMI OUT jack on your digital device.
2. Press the  button on the right side of the Soundbar or the **SOURCE** button on the remote control to select the **HDMI** mode.

OPTICAL OR ANALOGUE AUDIO CABLE

This unit comes equipped with one digital optical in jack and one analogue audio (AUX) in jack, giving you two ways to connect it to external devices.

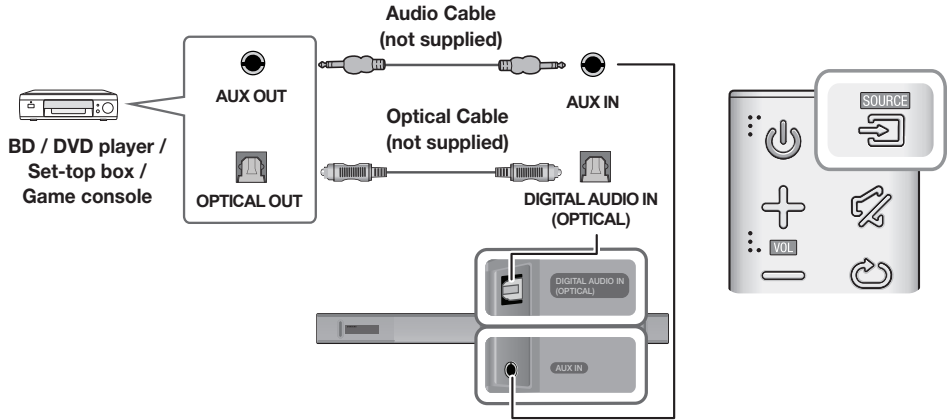

► AUX Cable

1. Connect **AUX IN** (Audio) on the main unit to the AUDIO OUT jack of the Source Device using an audio cable.
2. Press the  button on the right side of the Soundbar or the **SOURCE** button on the remote control to select the **AUX** mode.

► Optical Cable

1. Connect **DIGITAL AUDIO IN (OPTICAL)** on the main unit to the OPTICAL OUT jack of the Source Device using a digital optical cable.
2. Press the  button on the right side of the Soundbar or the **SOURCE** button on the remote control to select the **D.IN** mode.

INPUT MODE

Press the  button on the main unit's right side or the **SOURCE** button on the remote control to select the mode you want.



Right end of Soundbar

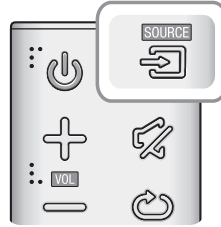

Input mode	Display
Optical Digital input ARC (HDMI OUT) input	D.IN
AUX input	AUX
HDMI input	HDMI
BLUETOOTH mode	BT
TV SoundConnect	TV

AUTO POWER DOWN FUNCTION

The unit turns off automatically in the following situations.

- D.IN / HDMI / BT / TV Mode
 - If there is no audio signal for 5 minutes.
- AUX Mode
 - If the AUX cable is disconnected for 5 minutes.
 - If there is no KEY input for 8 hours when the AUX cable is connected.

To turn the Auto Power Down function ON or OFF, press and hold the  button for 5 seconds.
ON - AUTO POWER DOWN / OFF - AUTO POWER DOWN appears on the display.

BLUETOOTH

You can connect a Bluetooth device to the Soundbar and enjoy music with stereo sound, all without wires!

TO CONNECT THE SOUNDBAR TO A BLUETOOTH DEVICE

Check if the Bluetooth device supports the Bluetooth compliant stereo headset function.



1. Press the  button on the main unit's right side or the **SOURCE** button on the remote control to select the **BT** mode.
 - You will see **BT READY** on the front display of the Soundbar.
2. Select the Bluetooth menu on the Bluetooth device you want to connect. (Refer to the Bluetooth device's user manual.)
3. Select "**[AV] Samsung Soundbar Kxxx**" from the list.
 - When the Soundbar is connected to the Bluetooth device, it will display **[Bluetooth device name] → BT** on the front display.
 - The device name can only be displayed in English. An underline " _ " will be displayed if the name is not in English.
 - If the Bluetooth device has failed to pair with the Soundbar, delete the previous "**[AV] Samsung Soundbar Kxxx**" found by the Bluetooth device and have it search for the Soundbar again.
4. Play music on the connected device.
 - You can listen to the music playing on the connected Bluetooth device over the Soundbar.
 - In **BT** mode, the Play / Pause / Next / Prev functions are not available. However, these functions are available on Bluetooth devices supporting AVRCP.



- If asked for a PIN code when connecting a Bluetooth device, enter <0000>.
- Only one Bluetooth device can be paired at a time.
- The Bluetooth connection will be terminated when you turn the Soundbar off.
- The Soundbar may not perform Bluetooth search or connection correctly under the following circumstances:
 - If there is a strong electrical field around the Soundbar.
 - If several Bluetooth devices are simultaneously paired with the Soundbar.
 - If the Bluetooth device is turned off, not in place, or malfunctions.
- Note that such devices as microwave ovens, wireless LAN adaptors, fluorescent lights, and gas stoves use the same frequency range as the Bluetooth device, which can cause electric interference.
- The Soundbar supports SBC data (44.1kHz, 48kHz).
- Connect only to a Bluetooth device that supports the A2DP (AV) function.
- You cannot connect the Soundbar to a Bluetooth device that supports only the HF (Hands Free) function.
- Once you have paired the Soundbar to a Bluetooth device, selecting "[AV] Samsung Soundbar Kxxx" from the device's scanned devices list will automatically change the Soundbar to **BT** mode.
 - Available only if the Soundbar is listed among the Bluetooth device's paired devices. (The Bluetooth device and the Soundbar must have been previously paired at least once.)
- Soundbar will appear in the Bluetooth device's searched devices list only when the Soundbar is displaying **BT READY**.
- In the TV SoundConnect mode, the Soundbar cannot be paired to another Bluetooth device.

BLUETOOTH POWER ON (BLUETOOTH POWER)

If a previously paired Bluetooth device tries to pair with the Soundbar when the Bluetooth POWER On function is on and the Soundbar is turned off, the Soundbar turns on automatically.

1. Press the **Bluetooth POWER** button on the remote while the Soundbar is turned on.
2. **ON - BLUETOOTH POWER** appears on the Soundbar's display.

TO DISCONNECT THE BLUETOOTH DEVICE FROM A SOUNDBAR

You can disconnect a Bluetooth device from the Soundbar. For instructions, see the Bluetooth device's user manual.

- The Soundbar will be disconnected.
- When the Soundbar is disconnected from the Bluetooth device, the Soundbar will display **BT DISCONNECTED** on the front display.

TO DISCONNECT THE SOUNDBAR FROM A BLUETOOTH DEVICE

Press the **SOURCE** button on the remote control or the  button on the product's right side to switch from **BT** to another mode or turn off the Soundbar.

- The connected Bluetooth device will wait a certain amount of time for a response from the Soundbar before terminating the connection. (Disconnection time may differ, depending on the Bluetooth device)



- In Bluetooth connection mode, the Bluetooth connection will be lost if the distance between the Soundbar and the Bluetooth device exceeds 10 meters.
- The Soundbar automatically turns off after 5 minutes in the Ready state.

► More About Bluetooth

Bluetooth is a technology that enables Bluetooth-compliant devices to interconnect easily with each other using a short wireless connection.

- A Bluetooth device may cause noise or malfunction, depending on usage, if:
 - A part of your body is in contact with the receiving/transmitting system of the Bluetooth device or the Soundbar.
 - It is subject to electrical variation from obstructions caused by a wall, corner, or office partition.
 - It is exposed to electrical interference from same frequency-band devices including medical equipment, microwave ovens, and wireless LANs.
- Pair the Soundbar with the Bluetooth device while they are close together.
- The further the distance between the Soundbar and Bluetooth device, the worse the quality is. If the distance exceeds the Bluetooth operational range, the connection is lost.
- In poor reception areas, the Bluetooth connection may not work properly.
- The Bluetooth connection only works when it is close to the unit. The connection will be automatically cut off if the Bluetooth device is out of range. Even within range, the sound quality may be degraded by obstacles such as walls or doors.
- This wireless device may cause electric interference during its operation.

USING THE MULTIROOM APP

The Samsung Multiroom app lets you connect the Soundbar to a smart device, your network, and the Internet. Once the Soundbar is connected to a smart device that has the Multiroom App installed, you can also connect the Soundbar and multiple Samsung Multiroom devices together wirelessly and play audio through them.

BEFORE YOU BEGIN

► Communication Basics

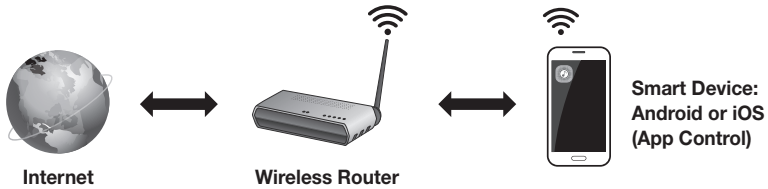

Requirements:

1. A Wireless Router and a Smart Device.
2. The wireless router must be connected to the Internet.
3. The smart device must be connected to the router via a Wi-Fi connection.

INSTALLING THE SAMSUNG MULTIROOM APP

To use the Soundbar with the Samsung Multiroom App, you must download and then install the Samsung Multiroom App on your smart device. You can download the app from Google Play or the App Store. With the Samsung Multiroom App installed, you can play music on your Soundbar that is stored on your smart device, located on other connected devices, provided by other content providers, or streamed from Internet radio stations.

► Android or iOS

Download the Samsung Multiroom app from Google Play or the App Store of your smart device.

* Market search : Samsung Multiroom



or



► Launching the Samsung Multiroom App

To launch the Samsung Multiroom app, tap the Multiroom app icon on your smart device.

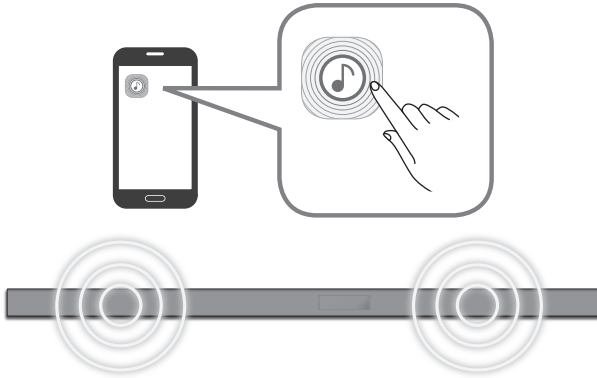

CONNECTING THE SOUNDBAR TO YOUR NETWORK

On your smart device, select the Samsung Multiroom app. Follow the directions on your smart device's screen. You can use the following music sources with the Samsung Multiroom app.

- Music files stored in your mobile phone, various music sources, and Internet radio.

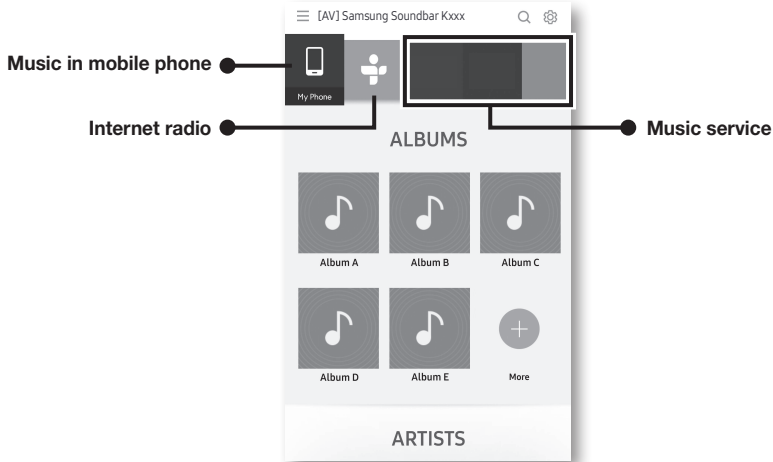

USING THE NETWORK STANDBY ON FUNCTION

The Network Standby On function becomes available if a wireless connection has been properly established between a smart device and the Soundbar. This function turns on the Soundbar automatically when a smart device attempts to connect to the Soundbar via Bluetooth or Wi-Fi. If you turn the Soundbar on via a Bluetooth connection, its input mode is set to BT automatically. To turn the Soundbar on via Wi-Fi, you must have the Samsung Multiroom App installed on your smart device.

1. Connect the smart device to your Soundbar.
2. Turn the Network Standby On function on by pressing the ►► button on the Soundbar remote for more than 5 seconds. You can turn the function off by pressing the ►► button again for more than 5 seconds.



- Network Standby On is available only if the Soundbar is listed among the smart device's paired devices. (The Smart device and the Soundbar must have been previously paired at least once.)
- Soundbar will appear in the smart device's searched devices list only when the Soundbar is displaying [BT READY] or [WiFi READY].
- In the TV SoundConnect mode, the Soundbar cannot be paired to another smart device.
- If the Network Standby On function did not work:
 - The Network Standby On is set to Off. Set it to ON.
- The Wi-Fi connection to the Soundbar will be terminated if the Soundbar's power cord is disconnected or the power is cut off. If the power is cut off, turn on the Soundbar and reconnect it.
- If the Network Standby is set to Off, the Soundbar cannot be turned on by Bluetooth connection.

SOFTWARE UPDATE

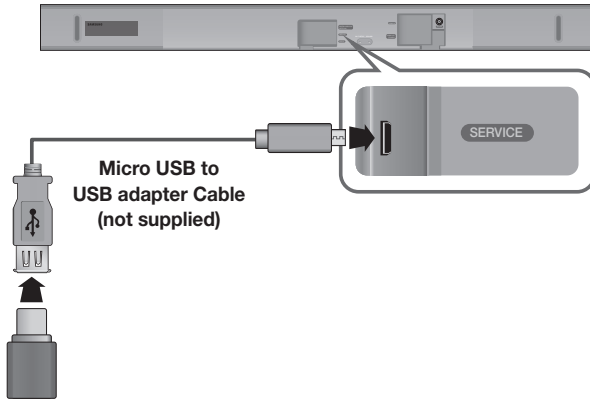

UPDATING WITH USB

Samsung may offer updates for the Soundbar's system firmware in the future.

If an update is offered, you can update the firmware by connecting a USB device with the firmware update stored on it to the USB port on your Soundbar.

Note that if there are multiple update files, you must load them onto the USB device singly and use them to update the firmware one file at a time.

Please visit samsung.com or contact the Samsung call centre to receive more information about downloading update files.

► Updating Procedure

1. Connect a Micro USB to USB adapter cable with a male USB 2.0 Micro USB plug (Type B) on one end and a standard female 2.0 USB jack (Type A) on the other end to the micro USB jack on your Soundbar.



- The Micro USB to USB adapter cable is sold separately. To purchase, contact a Samsung Service Centre or Samsung Customer Care.

2. Follow the steps below to download the product software:
Go to the Samsung website at (samsung.com/sec) → search for the model name - select the customer support option (the option name is subject to change)
3. Save the downloaded software to a USB stick and select "Extract to the folder name" to unzip the folder.
4. Turn off the Soundbar and connect the USB stick containing the software update to the female port on a Micro USB adapter cable.
5. Turn on the Soundbar. Within 3 minutes, **UPDATE** is displayed and updating begins.
6. After the update is complete, the Soundbar turns off and on again.

► If UPDATE was not displayed

1. Turn off the Soundbar, connect the USB storage device that contains update files to the Soundbar's USB port.
2. Disconnect the power cord, reconnect it, and then turn on the Soundbar.



- Insert a USB device containing the firmware update into the USB port on the main unit.
- Updating firmware may not work properly if audio files supported by the Soundbar are stored in the USB storage device.
- Do not disconnect the power or remove the USB device while updates are being applied. The main unit will turn off automatically after completing the firmware update.
- After update is completed, the user setup in Soundbar is initialised. We recommend you write down your settings so that you can easily reset them after the update. Note that updating firmware resets the subwoofer connection too.
If the connection to the subwoofer is not re-established automatically after the update, refer to page 16.
If the software update fails, check that the USB stick is not defective.
- Mac OS users should use MS-DOS (FAT) as the USB format.
- Depending on the manufacturer, some USB devices may not be supported.

AUTO UPDATE



If the Soundbar is connected to the Internet, it will automatically check for the latest firmware and update when new firmware becomes available, even if it is turned off.



- The Soundbar is configured to run Auto Update by default.
- To use the Auto Update function, the Soundbar must be connected to the Internet.
- The Wi-Fi connection to the Soundbar will be terminated if its power cord is disconnected or the power is cut off. If the power is cut off, turn on the Soundbar and reconnect it.

TROUBLESHOOTING

Before requesting service, please check the following.

The unit will not turn on.	
• Is the power cord plugged into the outlet?	→ Connect the power plug to the outlet.
A function does not work when the button is pressed.	
• Is there static electricity in the air?	→ Disconnect the power plug and connect it again.
Sound is not produced.	
• Is the Mute function on?	→ Press the  (Mute) button to cancel the Mute function.
• Is the volume set to minimum?	→ Adjust the volume.
The remote control does not work.	
• Are the batteries drained?	→ Replace with new batteries.
• Is the distance between the remote control and main unit too far?	→ Move closer to the unit.
The TV SoundConnect (TV pairing) failed.	
• Does your TV support TV SoundConnect?	→ TV SoundConnect is supported by some Samsung TVs released from 2012 on. Check your TV to see if it supports TV SoundConnect.
• Is your TV firmware the latest version?	→ Update your TV with the latest firmware.
• Does an error occur when connecting?	→ Contact the Samsung Call Centre. → Reset TV SoundConnect and connect again. To reset the TV SoundConnect connection, press and hold the  button for 5 seconds.
The red LED on the subwoofer blinks and the subwoofer is not producing sound.	
• Your subwoofer may not be connected to the main unit of the product.	→ Try to connect your subwoofer again. (See Page 16)
Soundbar is not turned on by Bluetooth or Multiroom App.	
• Check the Network Standby option is OFF.	→ If it's true, BT and Wifi functions are not allowed in power off state. Press and hold the  button for 5 seconds to turn on the Network Standby in power on state.

SPECIFICATIONS

GENERAL	Weight	Main Unit	2.6 kg
		Subwoofer (PS-WK650, PS-WK651)	6.8 kg
	Dimensions (W x H x D)	Main Unit	1010.5 x 54.0 x 87.5 mm
		Subwoofer (PS-WK650, PS-WK651)	452.0 x 335.0 x 154.0 mm
	Operating Temperature Range		+5°C to +35°C
	Operating Humidity Range		10 % to 75 %
AMPLIFIER	Rated Output Power	Main Unit	30W x 6, 6 ohm, THD \leq 10%
		Subwoofer (PS-WK650, PS-WK651)	160W, 3 ohm, THD \leq 10%

* Design, specifications and App screen are subject to change without prior notice.

* Nominal specification

- Samsung Electronics Co., Ltd reserves the right to change the specifications without notice.
- Weight and dimensions are approximate.
- For more information about the power supply and power consumption, refer to the label attached to the product.

※ **Precaution** : The product will restart automatically if you turn on/off Wi-Fi/Ethernet.

Overall Standby Power Consumption (W) (All the network ports are "ON" condition)		2.8W
Wi-Fi/Ethernet	Port deactivation method	Press Wi-Fi SETUP button on the product for 30 seconds or press the ▶▶ button on the Soundbar remote for more than 5 seconds to turn Wi-Fi/Ethernet On / Off.
Bluetooth	Port deactivation method	Press SPK ADD button on the product for 30 seconds or press the ▶▶ button on the Soundbar remote for more than 5 seconds to turn Bluetooth On / Off.

※ **Open Source Licence Notice**

- For further information on Open Sources used in this product, please visit the website:
<http://opensource.samsung.com>

※  **Spotify Licence**

- The Spotify Software is subject to third party licences found here :
www.spotify.com/connect/third-party-licenses.
- For more information about Spotify Connect, please visit www.spotify.com/connect

LICENCES



Manufactured under licence from Dolby Laboratories. Dolby, Dolby Audio and the double-D symbol are trademarks of Dolby Laboratories.



For DTS patents, see <http://patents.dts.com>. Manufactured under licence from DTS Licensing Limited. DTS, the Symbol, & DTS and the Symbol together are registered trademarks, and DTS 2.0 Channel is a trademark of DTS, Inc. © DTS, Inc. All Rights Reserved.

HDMI

The terms HDMI and HDMI High-Definition Multimedia Interface, and the HDMI Logo are trademarks or registered trademarks of HDMI Licensing LLC in the United States and other countries.

Wireless Models (including the frequency of 5.15GHz-5.35GHz)

Hereby, Samsung Electronics, declares that this equipment is in compliance with the essential requirements and other relevant provisions of Directive 1999/5/EC. The original Declaration of Conformity may be found at <http://www.samsung.com>, go to Support > Search Product Support and enter the model name. This equipment may be operated in all EU countries. This equipment may only be used indoors.



Wireless Models (excluding the frequency of 5.15GHz-5.35GHz)

Hereby, Samsung Electronics, declares that this equipment is in compliance with the essential requirements and other relevant provisions of Directive 1999/5/EC. The original Declaration of Conformity may be found at <http://www.samsung.com>, go to Support > Search Product Support and enter the model name. This equipment may be operated in all EU countries.





UNITED KINGDOM



EIRE

This Samsung product is warranted for the period of twelve (12) months from the original date of purchase, against defective materials and workmanship. In the event that warranty service is required, you should return the product to the retailer from whom it was purchased. However, Samsung Authorised Dealers and Authorised Service Centres in other EC Countries will comply with the warranty on the terms issued to purchasers in the country concerned. In case of difficulty, details of our Authorised Service Centres are available from:

Samsung Electronics U.K. Ltd
Samsung Customer Support Centre
Selectapost 38, Sheffield, S97 3FJ
United Kingdom

United Kingdom
Tel : 0330 SAMSUNG (7267864)
www.samsung.com/uk/support

EIRE
Tel : 0818 717100
www.samsung.com/ie/support

■ WARRANTY CONDITIONS

1. The warranty is only valid if, when warranty service is required, the warranty card is fully and properly completed and is presented with the original invoice or sales slip or confirmation, and the serial number on the product has not been defaced.
2. Samsung's obligations are limited to the repair or, at its discretion, replacement of the product or the defective part.
3. Warranty repairs must be carried out by Authorised Samsung Dealers or Authorised Service Centres. No re-imbursment will be made for repairs carried out by non Samsung Dealers and, any such repair work and damage to the products caused by such repair work will not be covered by this warranty.

4. This product is not considered to be defective in materials nor workmanship by reason that it requires adaptation in order to conform to national or local technical or safety standards in force in any Country other than the one for which the product was originally designed and manufactured. This warranty will not cover, and no re-imbursment will be made for such adaptation nor any damage which may result.
5. This warranty covers none of the following:
 - a) Periodic check ups, maintenance and repair or replacement of parts due to normal wear and tear.
 - b) Cost relating to transport, removal or installation of the product.
 - c) Misuse, including the failure to use this product for its normal purposes or incorrect installation.
 - d) Damage caused by Lightning, Water, Fire, Acts of God, War, Public Disturbances, incorrect mains voltage, improper ventilation or any other cause beyond the control of Samsung.
6. This warranty is valid for any person who legally acquired possession of the product during the warranty period.
7. The consumers statutory rights in any applicable national legislation whether against the retailer arising from the purchase contract or otherwise are not affected by this warranty. Unless there is national legislation to the contrary, the rights under this warranty are the consumers sole rights and Samsung, its subsidiaries and distributors shall not be liable for indirect or consequential loss or any damage to records, compact discs, videos or audio taper or any other related equipment or material.

SAMSUNG ELECTRONICS (U.K.) LTD.

SAMSUNG

Contact SAMSUNG WORLD WIDE

If you have any questions or comments relating to Samsung products, please contact the SAMSUNG customer care Centre.

Country	Contact Centre ☎	Web Site
Europe		
U.K	0330 SAMSUNG (7267864)	www.samsung.com/uk/support
EIRE	0818 717100	www.samsung.com/ie/support
GERMANY	0180 6 SAMSUNG bzw. 0180 6 7267864* (*0,20 €/Anruf aus dem dt. Festnetz, aus dem Mobilfunk max. 0,60 €/Anruf)	www.samsung.com/de/support
FRANCE	01 48 63 00 00	www.samsung.com/fr/support
ITALIA	800-SAMSUNG (800.7267864)	www.samsung.com/it/support
SPAIN	34902172678	www.samsung.com/es/support
PORTUGAL	808 20 7267	www.samsung.com/pt/support
LUXEMBURG	261 03 710	www.samsung.com/be_fr/support
NETHERLANDS	0900-SAMSUNG (0900-7267864) (€ 0,10/Min)	www.samsung.com/nl/support
BELGIUM	02-201-24-18	www.samsung.com/be/support (Dutch) www.samsung.com/be_fr/support (French)
NORWAY	815 56480	www.samsung.com/no/support
DENMARK	70 70 19 70	www.samsung.com/dk/support
FINLAND	030-6227 515	www.samsung.com/fi/support
SWEDEN	0771 726 7864 (0771-SAMSUNG)	www.samsung.com/se/support
POLAND	801-172-678* lub +48 22 607-93-33 * * (koszt połączenia według taryfy operatora)	www.samsung.com/pl/support
HUNGARY	0680SAMSUNG (0680-726-786) 0680PREMIUM (0680-773-648)	www.samsung.com/hu/support

Country	Contact Centre ☎	Web Site
AUSTRIA	0800-SAMSUNG (0800-7267864) [Only for Premium HA] 0800-366661 [Only for Dealers] 0810-112233	www.samsung.com/at/support
SWITZERLAND	0800 726 78 64 (0800-SAMSUNG)	www.samsung.com/ch/support (German) www.samsung.com/ch_fr/support (French)
CZECH	800 - SAMSUNG (800-726786)	www.samsung.com/cz/support
SLOVAKIA	0800 - SAMSUNG (0800-726 786)	www.samsung.com/sk/support
CROATIA	072 726 786	www.samsung.com/hr/support
BOSNIA	055 233 999	www.samsung.com/support
MONTENEGRO	020 405 888	www.samsung.com/support
SLOVENIA	080 697 267 (brezplačna številka)	www.samsung.com/si
SERBIA	011 321 6899	www.samsung.com/rs/support
BULGARIA	*3000 Цена в мрежата 0800 111 31. Безплатна телефонна линия	www.samsung.com/bg/support
ROMANIA	*8000 (apel in retea) 08008-726-78-64 (08008-SAMSUNG) Apel GRATUIT	www.samsung.com/ro/support
CYPRUS	8009 4000 only from landline, toll free	www.samsung.com/gr/support
GREECE	80111-SAMSUNG (80111 726 7864) only from land line (+30) 210 6897691 from mobile and land line	www.samsung.com/gr/support
LITHUANIA	8-800-77777	www.samsung.com/lt/support
LATVIA	8000-7267	www.samsung.com/lv/support
ESTONIA	800-7267	www.samsung.com/ee/support



[Correct disposal of batteries in this product]

(Applicable in countries with separate collection systems)

This marking on the battery, manual or packaging indicates that the batteries in this product should not be disposed of with other household waste at the end of their working life. Where marked, the chemical symbols Hg, Cd or Pb indicate that the battery contains mercury, cadmium or lead above the reference levels in EC Directive 2006/66. If batteries are not properly disposed of, these substances can cause harm to human health or the environment.

To protect natural resources and to promote material reuse, please separate batteries from other types of waste and recycle them through your local, free battery return system.



**Correct Disposal of This Product
(Waste Electrical & Electronic Equipment)**

(Applicable in countries with separate collection systems)

This marking on the product, accessories or literature indicates that the product and its electronic accessories (e.g. charger, headset, USB cable) should not be disposed of with other household waste at the end of their working life. To prevent possible harm to the environment or human health from uncontrolled waste disposal, please separate these items from other types of waste and recycle them responsibly to promote the sustainable reuse of material resources.

Household users should contact either the retailer where they purchased this product, or their local government office, for details of where and how they can take these items for environmentally safe recycling.

Business users should contact their supplier and check the terms and conditions of the purchase contract. This product and its electronic accessories should not be mixed with other commercial wastes for disposal.

For information on Samsung's environmental commitments and product specific regulatory obligations e.g. REACH visit: samsung.com/uk/aboutsamsung/samsungelectronics/corporatecitizenship/data_corner.html