

## Operating and installation instructions Freezer



To avoid the risk of accidents or damage to the appliance it is **essen-  
tial** to read these instructions before it is installed and used for the  
first time.

# Contents

---

<b>Warning and Safety instructions</b> .....	4
<b>Caring for the environment</b> .....	12
<b>Saving energy</b> .....	13
<b>Guide to the appliance</b> .....	15
<b>Switching on and off</b> .....	17
Before using for the first time .....	17
Switching off .....	17
Switching off for longer periods of time .....	18
<b>The correct temperature</b> .....	19
Setting the temperature .....	19
Temperature display .....	20
<b>Using Super freeze</b> .....	21
Super freeze function .....	21
<b>Temperature alarm</b> .....	22
<b>Selecting further settings</b> .....	23
Settings mode .....	23
Activating or deactivating the lock .....	23
<b>Freezing and storing food</b> .....	26
Maximum freezing capacity .....	26
Freezing fresh food .....	26
Storing frozen food .....	26
Home freezing .....	27
Before placing food in the appliance .....	28
Storage time for frozen food .....	29
Defrosting frozen goods .....	29
Cooling drinks quickly .....	30
Adjusting the interior fittings .....	30
Using accessories .....	30
<b>Defrosting</b> .....	31
<b>Cleaning and care</b> .....	33
Cleaning agents .....	33
Preparing the appliance for cleaning .....	34
Cleaning the interior and accessories .....	34
Cleaning the front of the appliance and the side panels .....	34
Cleaning the door seal .....	35

---

Cleaning the ventilation gaps .....	35
Cleaning the compressor and metal grille at the back of the appliance .....	35
After cleaning .....	35
<b>Problem solving guide</b> .....	36
<b>Noises</b> .....	41
<b>Service</b> .....	42
Contact in the event of a fault .....	42
EPREL database .....	42
Warranty .....	42
<b>Installation</b> .....	43
Installation .....	43
Side-by-side combinations .....	43
Location .....	43
Ventilation .....	45
Appliances supplied with wall spacers .....	45
Installing the appliance .....	46
Installing the refrigeration appliance in a run of kitchen units .....	47
Appliance dimensions .....	49
Changing the door hinging .....	50
Changing over the door handle .....	51
Electrical connection .....	53

# Warning and Safety instructions

---

This refrigeration appliance complies with current safety requirements. Inappropriate use can, however, lead to personal injury and material damage.

Please read the operating and installation instructions carefully before using the refrigeration appliance for the first time. They contain important information on safety, installation, use and maintenance. This is to protect yourself from injury, and from damaging your refrigeration appliance.

In accordance with standard IEC 60335-1, Miele expressly and strongly advises that you read and follow the instructions in the chapter on installing the appliance as well as the safety instructions and warnings.

Miele cannot be held liable for injury or damage caused by non-compliance with these instructions.

Keep these instructions in a safe place and pass them on to any future owner.

## Correct application

- ▶ This refrigeration appliance is intended for use in the home and in similar environments, for example
  - in shops, offices and similar work settings
  - by the guests in hotels, motels, bed & breakfasts and other typical home settings.

This refrigeration appliance is not intended for outdoor use.

- ▶ It must only be used as a domestic appliance to store deep frozen food, freeze fresh food and to make ice.  
Any other usage is not supported by the manufacturer and could be dangerous.

## Warning and Safety instructions

---

▶ This refrigeration appliance is not suitable for storing and keeping cool medicines, blood plasma, laboratory preparations or similar substances or products that are subject to the the Medical Device Directive. Incorrect use of the refrigeration appliance for such purposes may cause deterioration of the items stored. The refrigeration appliance is also not suitable for use in areas where there is a risk of explosion.

Miele cannot be held liable for damage caused by improper or incorrect use or operation of the appliance.

▶ The appliance can only be used by people with reduced physical, sensory or mental capabilities, or lack of experience and knowledge, if they are supervised whilst using it, or have been shown how to use it in a safe way and recognise and understand the consequences of incorrect operation.

### **Safety with children**

▶ Children under 8 years of age must be kept away from the refrigeration appliance unless they are constantly supervised.

▶ Children 8 years and older may only use the appliance unsupervised if they have been shown how to use it in a safe way and recognise and understand the consequences of incorrect operation.

▶ Children must not be allowed to clean or maintain the appliance unsupervised.

▶ Please supervise children in the vicinity of the appliance and do not let them play with it.

▶ Danger of suffocation! Whilst playing, children could become entangled in packaging (such as plastic wrapping) or pull it over their head and suffocate. Keep packaging material away from children.

# Warning and Safety instructions

---

## Technical safety

▶ The coolant circuit has been checked for leaks. The refrigeration appliance complies with statutory safety requirements and the appropriate EU directives.



▶ This refrigeration appliance contains the refrigerant isobutane (R600a), a natural gas which is environmentally friendly but flammable. The refrigerant does not damage the ozone layer and does not contribute to the greenhouse effect.

The use of this refrigerant has, however, led to a slight increase in the noise level of the appliance. In addition to the noise of the compressor, you might be able to hear the refrigerant flowing around the cooling circuit. Unfortunately, this cannot be avoided, but it does not affect the performance of the refrigeration appliance.

When transporting and installing the refrigeration appliance, ensure that no parts of the cooling circuit are damaged. Splashes of refrigerant can damage the eyes.

In the event of damage:

- Avoid naked flames or anything which creates a spark.
  - Disconnect the refrigeration appliance from the mains electricity supply.
  - Ventilate the room where the refrigeration appliance is located for several minutes.
  - Contact the Miele Customer Service Department.
- ▶ The more coolant there is in a refrigeration appliance, the larger the room it should be installed in. In the event of a leakage, if the appliance is in a small room, there is the danger of a combustible gas/air mixture building up. For every 11 g of coolant at least 1 m<sup>3</sup> of room space is required. The amount of coolant in the refrigeration appliance is stated on the data plate inside the appliance.

## Warning and Safety instructions

---

- ▶ To avoid the risk of damage to the appliance, make sure that the connection data (fuse rating, frequency and voltage) on the data plate corresponds to the household supply. Check that this is the case before connecting the appliance. Consult a qualified electrician if in any doubt.
- ▶ The electrical safety of this appliance can only be guaranteed when correctly earthed. It is essential that this standard safety requirement is met. If in any doubt please have the electrical installation tested by a qualified electrician.
- ▶ Reliable and safe operation of this appliance can only be assured if it has been connected to the mains electricity supply.
- ▶ If the electrical connection cable is faulty it must only be replaced by a Miele authorised service technician to protect the user from danger.
- ▶ Do not connect the appliance to the mains electrical supply by a multi-socket adapter or extension lead. These are a fire hazard and do not guarantee the required safety of the appliance.
- ▶ If moisture gets into electrical components or into the mains connection cable, it could cause a short circuit. Therefore, do not operate this refrigeration appliance in areas which are exposed to moisture (e.g in a garage or utility room).
- ▶ This appliance must not be used in a non-stationary location (e.g. on a ship).
- ▶ Do not use a damaged appliance. It could be dangerous. Check the appliance for visible signs of damage.
- ▶ The appliance must be isolated from the electricity supply during installation, maintenance and repair work.
- ▶ Unauthorised installation, maintenance and repairs can cause considerable danger for the user. Installation, maintenance and repairs must only be carried out by a Miele authorised technician.

## Warning and Safety instructions

---

- ▶ While the appliance is under warranty, repairs should only be undertaken by a Miele authorised service technician. Otherwise the warranty is invalidated.
- ▶ Miele can only guarantee the safety of the appliance when genuine original Miele replacement parts are used. Faulty components must only be replaced by Miele spare parts.

### Correct use

- ▶ The appliance is designed for use within a certain climate range (ambient temperatures), and should not be used outside this range. The climate range for your appliance is stated on the data plate inside the appliance. Installing it in a room with too low an ambient temperature, e.g. a garage, will lead to the appliance switching off for longer periods so that it cannot maintain the required temperature.
- ▶ Do not cover or block the air vents as this could impair the efficiency of the appliance, increase the electricity consumption and could cause damage to the components.
- ▶ The refrigeration appliance lid has a plastic edge. Make sure that no oil or grease leaks onto this edge as this could cause stress cracks in the plastic and cause it to break or split.
- ▶ If storing food which contains a lot of fat or oil in the appliance or the door, make sure that it does not come into contact with plastic components as this could cause stress cracks or break the plastic.
- ▶ Risk of fire and explosion. Do not store explosive materials in the refrigeration appliance or any products containing propellants (e.g. spray cans). Electrical components can cause flammable mixes of gases to ignite.
- ▶ Danger of explosion. Do not operate any electrical equipment (e.g. an electric ice-cream maker) inside the refrigeration appliance. Danger of sparking and explosion.

## Warning and Safety instructions

---

- ▶ Do not store cans or bottles containing carbonated drinks or liquids which could freeze in the freezer. The cans or bottles could explode. Danger of injury and damage to the appliance.
- ▶ When cooling drinks quickly in the freezer, make sure bottles are not left in for more than one hour; otherwise they could burst, causing injury or damage.
- ▶ Danger of injury. Never handle frozen food or the metal parts of the appliance with wet hands. Your hands may freeze to the frozen food or to the metal.
- ▶ Danger of injury. Do not take ice cubes out with your bare hands and never place ice cubes or ice lollies in your mouth straight from the freezer zone. The very low temperature of the frozen food can cause frost burn to the lips and tongue.
- ▶ Do not refreeze partially or fully defrosted food. Consume defrosted food as soon as possible, as it will lose its nutritional value and spoil if left for too long. Defrosted food may only be re-frozen after it has been cooked.
- ▶ Observe the manufacturer's "use-by" dates and storage instructions given on food to avoid the risk of food poisoning. Storage times will depend on several factors, including the freshness and quality of the food, as well as the temperature at which it is stored.
- ▶ Only use genuine original Miele accessories and spare parts with this appliance. Using accessories or spare parts from other manufacturers will invalidate the warranty, and Miele cannot accept liability.

### Accessories and spare parts

- ▶ Only use genuine original Miele accessories and spare parts with this appliance. Using accessories or spare parts from other manufacturers will invalidate the warranty, and Miele cannot accept liability.

## Warning and Safety instructions

---

▶ Miele will guarantee to supply functional spare parts for 15 years following the discontinuation of your refrigeration appliance.

### Cleaning and care

▶ Do not use any oils or grease on the door seals, as these will cause the seals to deteriorate and become porous with time.

▶ Do not use a steam cleaning appliance to clean or defrost this appliance.

Steam could reach electrical components and cause a short circuit.

▶ Sharp edged or pointed objects will damage the evaporator, causing irreversible damage to the appliance. Do not use sharp edged or pointed objects to

- remove frost and ice,
- separate frozen foods or remove ice trays.

▶ Do not place electric heaters or candles in the appliance to defrost it. These can damage the plastic parts.

▶ Do not use defrosting sprays or de-icers, as they could contain substances which could damage the plastic parts or which might cause the build-up of gases and pose a danger to health.

### Transport

▶ Always transport the appliance in an upright position and in its original transport packaging to avoid damage in transit.

▶ Danger of injury and damage to the appliance. The refrigeration appliance is very heavy and must be transported by two people.

## Disposal of your old appliance

- ▶ If your old refrigeration appliance has a door lock, destroy it. This will prevent the risk of children playing accidentally locking themselves in and endangering their lives.
- ▶ Splashes of coolant can damage the eyes. Be careful not to damage any part of the pipework whilst awaiting disposal, e.g. by
  - puncturing the coolant channels in the condenser,
  - bending any pipework, or
  - scratching the surface coating.

## Symbol on the compressor (depending on model)

This information is only relevant for recycling. There is no risk during normal operation.



- ▶ The oil in the compressor can be fatal if swallowed or if it penetrates the airways.

# Caring for the environment

---

## Disposal of the packing material

The packaging is designed to protect the appliance from damage during transportation. The packaging materials used are selected from materials which are environmentally friendly for disposal and should be recycled.

Recycling the packaging reduces the use of raw materials in the manufacturing process and also reduces the amount of waste in landfill sites.

## Disposing of your old appliance

Electronic and electrical appliances contain many valuable materials. They also contain certain materials, compounds and components which were essential for their correct functioning and safety. These could be hazardous to your health and to the environment if disposed of with general waste or if handled incorrectly. Please do not, therefore, dispose of your old appliance with general waste.

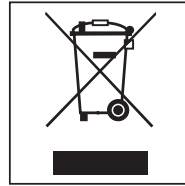

Instead, please make use of officially designated collection and disposal points to dispose of and recycle electrical and electronic appliances in your local community, with your dealer or with Miele. By law, you are solely responsible for deleting any personal data from the appliance prior to disposal.

Take care not to damage your refrigeration appliance's pipework before or during transportation to an authorised collection depot.

This is to ensure that coolant in the cooling circuit and oil in the compressor is contained, and will not leak into the environment.

Please ensure that your old appliance poses no risk to children while being stored prior to disposal. For further information, see "Warning and Safety instructions" in these operating and installation instructions.

## Saving energy

	<b>Normal energy consumption</b>	<b>Increased energy consumption</b>
<b>Installation / Maintenance</b>	In a ventilated room.	In an enclosed, unventilated room.
	Protected from direct sunlight.	In direct sunlight.
	Not near to a heat source (radiator, oven).	Near to a heat source (radiator, oven).
	Where the ideal ambient room temperature is approx. 20 °C.	Where the ambient room temperature is above 25 °C.
	Ventilation gaps uncovered and dusted regularly.	Ventilation gaps covered or dusty.
	Compressor and metal grille (heat exchanger) at the back of the appliance dusted at least once a year.	Dust build-up on the compressor and metal grille (heat exchanger).
<b>Temperature setting</b>	Freezer section -18 °C	The lower the temperature in the appliance, the higher the energy consumption.

# Saving energy

	<b>Normal energy consumption</b>	<b>Increased energy consumption</b>
<b>Use</b>	Drawers and shelves arranged as they were when the appliance was delivered.	
	Only open the door when necessary and for as short a time as possible. Store food in an organised way.	Frequent opening of doors for long periods will cause a loss of coldness. The appliance will try to cool down and the compressor will run for longer periods.
	Take an insulated cool bag when shopping, and load food in the appliance as soon as possible. Allow hot food and drinks to cool down before placing them in the appliance.	Hot food or food at room temperature raises the temperature inside the appliance. The appliance will try to cool down and the compressor will run for longer periods.
	Store food well packaged.	The evaporation or condensation of liquids in the freezer zone will cause a loss of coldness.
	Do not over-fill the appliance to allow air to circulate.	Poor air circulation will cause a loss of coldness.
<b>Defrosting</b>	Defrost the freezer when a layer of ice 0.5 cm (max.) thick has built up.	A build-up of ice slows down the cooling process.

# Guide to the appliance

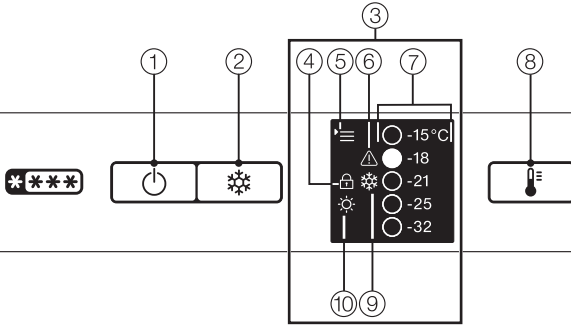

① On / Off button

② Super freeze button

③ Display

The brightness of the display changes automatically to the set brightness level if the appliance has not been used for a while. As soon as a button is touched the display lights up to the maximum brightness level.

④ Lock symbol

⑤ Menu symbol

(Settings mode:  
for altering the display brightness level,  
for switching the lock on/off).

⑥ Alarm symbol

⑦ Temperature display

⑧ Temperature selector button

⑨ Super freeze symbol

⑩ Display brightness symbol

## Guide to the appliance

---

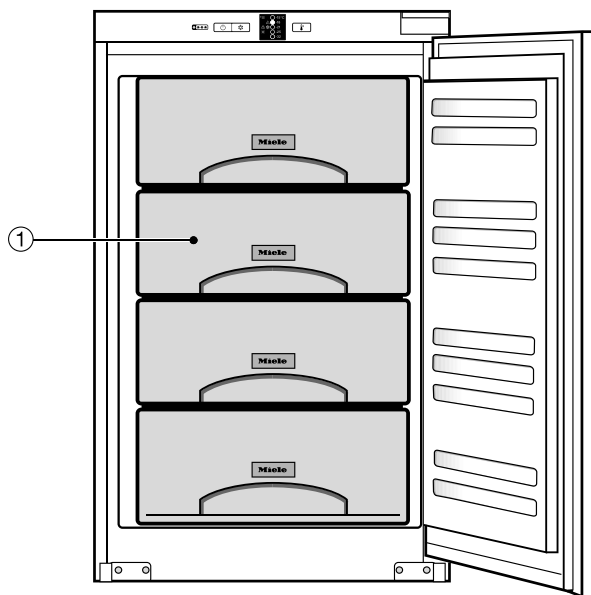

This drawing is for illustration purposes only.

① Freezer drawers (number depends on model)

## Before using for the first time

### Packaging material

- Remove all packaging material from the inside of the appliance.

### Protective foil

The appliance is covered with a special foil to protect it during transportation.

- Do not remove the foil until the appliance has been positioned in its final location.

### Cleaning

Please refer to the relevant instructions in "Cleaning and care".

- Clean the inside of the appliance and the accessories.

## Switching the refrigeration appliance on

To enable the temperature to get sufficiently cold inside the refrigeration appliance, allow the appliance to run for approx. 2 hours before placing food in it.

Do not place food in the freezer zone until it has reached the required coldness (at least  $-18\text{ }^{\circ}\text{C}$ ).

The compressor can take up to 8 minutes to switch on due to a built-in switch delay. This delay is designed to increase the service life of the compressor.



- Press the On/Off button.

The refrigeration appliance will start cooling. The temperature display and the alarm symbol will flash until the freezer zone is cold enough to use.

## Switching off



- Press the On/Off button until the display goes out.

The cooling system switches off. If this does not happen, the lock is on (see "Selecting further settings - To deactivate the lock").

# Switching on and off

---

## Switching off for longer periods of time

If, during a long absence, the refrigeration appliance is switched off but not cleaned and the door(s) left shut, there is a risk of mould forming inside the appliance.

It is essential to clean the refrigeration appliance.

If the refrigeration appliance is not going to be used for a longer period of time, observe the following:

- Switch the refrigeration appliance off.
- Switch off at the wall socket and withdraw the plug from the socket, or disconnect the fuse.
- Defrost the freezer.
- Clean the refrigeration appliance and leave the door ajar to air the appliance and avoid odours building up inside.

# The correct temperature

It is very important to set the correct temperature for storing food in the appliance. Bacteria will cause food which is not stored at the correct temperature to deteriorate rapidly. Temperature influences the growth rate of these bacteria. Reducing the temperature reduces their growth rate.

To freeze fresh food and to store frozen food for long periods, a temperature of **-18 °C** is required. At this temperature the growth of bacteria is generally halted. As soon as the temperature rises above -10 °C, the bacteria become active in the food again so it cannot be kept as long. For this reason, partially defrosted or defrosted food must not be re-frozen. Food may be re-frozen once it has been cooked, as the high temperatures achieved when cooking destroy most bacteria.

The temperature in the refrigeration appliance will rise:

- The more often the appliance door is opened and the longer it is kept open.
- The more food is stored in it.
- The warmer the food is which is being put into it.
- The higher the ambient temperature surrounding the refrigeration appliance. This refrigeration appliance is designed for use within specific ambient temperatures (climate range). Do not use in ambient temperatures for which it is not designed.

## Setting the temperature



- Press the button for setting the temperature repeatedly until the temperature you want lights up in the temperature display.

The first time you press the button the last temperature set will flash in the display.

The temperature value will change up until the setting for -32 °C is reached. It will then drop back to the -15 °C setting.

The temperature can be set slightly colder within the displayed ranges (e.g. between -15 °C and -18 °C).

- Press the button for setting the temperature repeatedly until the indicator for -15 °C lights up.
- Press the button for selecting the temperature again for approx. 5 seconds until -18 °C appears in the temperature display.

The colder temperature setting within this small temperature range has now been applied.

# The correct temperature

---

## Temperature display

The temperature display on the control panel always shows the required temperature.

The temperature can be adjusted from  $-15\text{ }^{\circ}\text{C}$  to  $-32\text{ }^{\circ}\text{C}$ .

The temperature display will flash if:

- The temperature is not within the range that can be displayed, e.g. because the refrigeration appliance has just been switched on.
- A different temperature has just been set.
- The temperature in the appliance has risen by several degrees, indicating that the appliance is warming up too much.

This short-term loss of coldness is no cause for concern if:

- The door has been left open for a while, e.g. for removing or storing a large amount of frozen food.
- Fresh food is being frozen.

The temperature display will light up constantly once the temperature has dropped and reached approx.  $-10\text{ }^{\circ}\text{C}$ .

## Super freeze function

Switch on Super freeze before putting fresh food into the freezer.

This helps food to freeze quickly and retain its nutrients, vitamins, flavours and appearance.

### Exceptions! This is not necessary:

- when placing food in the freezer that is already frozen.
- when freezing up to 1 kg fresh food daily.

## Switching on Super freeze

When freezing small quantities of food in the freezer, the Super freeze function should be switched on **6 hours beforehand**. When freezing **the maximum load of food**, the Super freeze function should be switched on **24 hours beforehand**.



- Press the Super freeze button briefly.

The Super freeze symbol ❄️ will light up. The appliance will work at full power to lower the temperature in the appliance.

The compressor can take up to 8 minutes to switch on due to a built-in switch delay. This delay is designed to increase the lifespan of the compressor.

## Switching off Super freeze

The Super freeze function will switch off automatically after approx. 65 hours. The Super freeze symbol ❄️ will go out and the appliance will run at normal power again.

To save energy, you can switch off the SuperFreeze function once the freezer reaches a constant temperature of at least -18 °C .



- Press the Super freeze button until the symbol ❄️ goes out.

The appliance will continue running at normal power.

# Temperature alarm

---

The appliance has been fitted with a warning system which ensures that the temperature in the freezer cannot rise unnoticed.

 Health risk caused by decomposing food.

If the temperature in the freezer remains above  $-18\text{ }^{\circ}\text{C}$  for a long time, the frozen food can start to defrost. This will reduce the storage life of the food.

Check whether the frozen food has started to defrost. If it has, check that the food is safe to use and if it is, use it as soon as possible or cook it before freezing it again.

If the temperature in the freezer becomes too warm, the temperature display and the alarm symbol  will flash.

The temperature the refrigeration appliance is set at determines the temperature the appliance recognises as being too warm.

Visual signals will be activated, for example, if:

- You switch on the refrigeration appliance and the temperature in a temperature zone differs greatly from the set temperature.
- A lot of warm room air enters the freezer when you are rearranging or taking out frozen food.
- You are freezing large amounts of food at once.
- You are freezing warm food.
- There was a mains outage.

- The refrigeration appliance has a fault.

The alarm symbol  will go out when the temperature reaches the correct level again.

## Selecting further settings

### Settings mode

Certain settings on the appliance can only be selected in settings mode.

Display brightness	☀
Activating or deactivating the lock	🔒

Settings mode is represented in the display by the menu symbol .

The procedure for accessing settings mode and for changing settings is described below.



### Activating or deactivating the lock

The lock can be activated to prevent the appliance being switched off by mistake.

#### - To activate the lock



- Press the Super freeze button for approx. 5 seconds.

The menu symbol  will light up. Settings mode is now active with the lock symbol  flashing.





- Press the Super freeze button briefly to access the lock function.

The lock symbol  will light up. The -15 °C and -21 °C fields in the temperature display light up.



- Press the Super freeze button briefly to activate the lock.

The lock symbol  will flash. The -15 °C and -21 °C fields in the temperature display go out. The lock symbol  lights up.



- Press the On/Off button to exit Settings mode,

or



- wait for 5 minutes.

The menu symbol goes out and the temperature display shows the required temperature. The lock symbol  lights up.

#### - To deactivate the lock



- Press the Super freeze button for approx. 5 seconds.

The menu symbol  will light up. Settings mode is now active with the lock symbol  flashing.



- Press the Super freeze button briefly to access the lock function.

## Selecting further settings

The lock symbol  will light up as well as the -18 °C field in the temperature display.



- Press the Super freeze button briefly to deactivate the lock.

The lock symbol  will start flashing and the -18 °C field in the temperature display will go out.



- Press the On/Off button to exit Settings mode,

or

- wait for 5 minutes.

The menu symbol goes out and the temperature display shows the required temperature. The lock symbol  goes out.



## Altering the display brightness

The display brightness can be adjusted to suit lighting conditions in the room.

The display brightness can be set to one of 5 different settings. It is set to level 1 ex-works.





- Press the Super freeze button for approx. 5 seconds.

The Menu symbol  will light up and the lock symbol  will start flashing to show that settings mode is now activated.





- Press the button for setting the temperature to access the display brightness function.

The lock symbol  go out and the display brightness symbol  will start flashing.



- Press the Super freeze button briefly to confirm your choice.

The display brightness symbol  will light up.  will light up.



- Press the button for setting the temperature repeatedly until the brightness level you want is reached.

The more fields that are lit up in the temperature display, the brighter the display.



- Press the Super freeze button briefly to confirm your choice.

The display brightness ☀ symbol will start flashing and the new settings is now active.

To come out of Settings mode:



- Press the On/Off button,  
or
- wait 5 minutes.

The menu symbol and the display brightness symbol both go out. The required temperature now shows in the display.

# Freezing and storing food

---

## Maximum freezing capacity

To ensure that fresh food placed in the freezer freezes through to the core as quickly as possible, the maximum freezing capacity must not be exceeded. The maximum freezing capacity for freezing within a 24-hour period is given on the data plate: “Freezing capacity ....kg/24 hrs”.

The maximum freezing capacity given on the data plate has been calculated according to DIN EN ISO 15502 Standard.

## Freezing fresh food

Fresh food should be frozen as quickly as possible. This way the nutritional value of the food, its vitamin content, appearance and taste are not impaired.

Food which takes a long time to freeze will lose more water from its cells, which then shrink. During the defrosting process, only some of this water is re-absorbed by the cells. What this means in practice is that the food loses more moisture. You can see this in the large amount of water that collects around the food when it defrosts.

If food is frozen quickly, the cells have less time to lose moisture, so they shrink less. As there is not so much moisture loss, it is easier for the food to reabsorb it during the defrosting process, and very little water collects around the defrosted food.

## Storing frozen food

Never re-freeze partially or fully defrosted food. Defrosted food may only be re-frozen after it has been cooked.

When buying frozen food to store in your freezer, check:

- That the packaging is not damaged
- The use-by date
- The temperature at which the frozen food is being stored in the shop.

The length of time food can be kept is reduced if it has been stored at a temperature warmer than  $-18^{\circ}\text{C}$ .

- Buy frozen food once you have finished the rest of your shopping and wrap it in newspaper or use a cool bag or cool box to transport it.
- Put it into the freezer as soon as possible.

## Home freezing

Only freeze fresh food which is in a good condition.

### Hints on home freezing

- The following types of food **are suitable** for freezing:  
Fresh meat, poultry, game, fish, vegetables, herbs, fresh fruit, dairy products, cakes, leftovers, egg yolks, egg whites and a range of pre-cooked meals.
- The following types of food **are not suitable** for freezing:  
Grapes, lettuce, radishes, soured cream, mayonnaise, eggs in their shells, onions, whole raw apples and pears.
- To retain colour, taste, aroma and vitamin C, vegetables should be blanched before they are frozen. To do so place them portion by portion into boiling water for 2–3 minutes. Remove, and plunge into ice-cold water to cool quickly. Drain and pack ready for freezing.
- Lean meat freezes better than fatty meat, and can be stored for considerably longer.
- Separate chops, steaks, cutlets etc. with a sheet of plastic freezer film. This prevents them from freezing together in a block.
- Do not salt or season raw food or blanched vegetables before freezing. Cooked food should only be lightly salted and seasoned. Some herbs intensify the taste of food when frozen.

- Placing hot foods or drinks in the freezer causes food that is already frozen to partially thaw and increases energy consumption. Allow hot foods and drinks to cool down before placing them in the freezer.

### Packaging food for freezing

- Freeze food in portions.
  - **Suitable packing material**
    - Plastic freezer bags
    - Tubular polythene freezer bags
    - Aluminum foil
    - Freezer containers
  - **Unsuitable packing material**
    - Wrapping paper
    - Greaseproof paper
    - Cellophane
    - Bin bags
    - Plastic carrier bags
  - Expel as much air as possible from the packaging.
  - Close the packaging tightly with
    - Rubber bands
    - Plastic clips
    - String
    - Freezer tape
- Tip:** Freezer bags may also be sealed using home heat sealing kits.
- Make a note of the contents and the date of freezing on the packaging.

# Freezing and storing food

---

## Before placing food in the appliance

- When freezing more than 1 kg of fresh food, switch on the Super freeze function some time before placing the food in the freezer (see “Super freeze”).

This helps create a cold reserve in food which is already stored in the freezer.

## Placing food in the freezer



If the food is too heavy, this can cause damage.

Loading food which is too heavy can cause damage to the freezer drawers/glass shelves.

Do not exceed the relevant maximum load:

- freezer drawer = 25 kg
- glass shelf = 35 kg

Unfrozen food should not touch frozen food as this will cause frozen food to begin to thaw.

- Make sure that the packaging and containers are dry to prevent them sticking together when frozen.

## – Freezing small amounts of food

Place the food in the lower freezer drawers.

- Place the food flat in the bottom of the freezer drawers so that it freezes through to the core as quickly as possible.

## – Freezing the maximum amount of food (see data plate)

- Remove the lowest freezer drawer.
- Place the frozen goods flat on the bottom of the appliance or in contact with the interior cabinet side walls, so that it freezes through to the core as quickly as possible.

Once frozen:

- Place the frozen goods in the freezer drawer and push it back in.

## Storage time for frozen food

The storage life of food is very variable, even at a constant temperature of  $-18\text{ }^{\circ}\text{C}$ . Decomposition processes also take place in frozen food, albeit at a very reduced speed. For example, fat can become rancid from contact with oxygen in the air. This is why lean meat can be stored approx. twice as long as fatty meat.

The storage times quoted are guide values for the storage life of different food groups in the freezer zone.

Food group	Storage time (Months)
Ice cream	2 to 6
Bread, baked goods	2 to 6
Cheese	2 to 4
Fish, oily	1 to 2
Fish, lean	1 to 5
Sausage, ham	1 to 3
Game, pork	1 to 12
Poultry, beef	2 to 10
Vegetables, fruit	6 to 18
Herbs	6 to 10

For standard freezing results, follow the advice on packaging.

By keeping the freezer zone at a constant temperature of  $-18\text{ }^{\circ}\text{C}$  and taking appropriate hygiene measures you can maximise the storage life of your food and avoid food waste.

## Defrosting frozen goods

Never re-freeze partially or fully defrosted food. Defrosted food may only be re-frozen after it has been cooked.

Frozen goods can be defrosted in different ways:

- In a microwave oven
- In an oven using “Fan heat” or the “Defrost” setting
- At room temperature
- In the refrigerator zone (the cold given off by the frozen food helps to keep the other food cold)
- In a steam oven

**Flat pieces of partially thawed meat or fish** can be placed directly into a hot frying pan.

**Meat and poultry** (e.g. mince, chicken, fish fillets) should not come into contact with other foods while defrosting. Catch the liquid from defrosting and dispose of it carefully.

**Fruit** should be defrosted at room temperature in its packaging, or in a covered bowl.

**Most vegetables** can be cooked while still frozen. Just put straight into boiling water or hot fat. The cooking time is slightly less than that of fresh vegetables due to changes in the cell structure.

# Freezing and storing food

---

## Cooling drinks quickly

When cooling drinks quickly in the freezer, make sure bottles are **not left in for more than one hour**; otherwise they could burst, causing injury and damage.

## Adjusting the interior fittings

### Removing the drawers and glass plates from the freezer

The drawers can be removed for filling, emptying or cleaning purposes.

You can also use the space in the freezer more flexibly. If you wish to freeze large items such as a turkey or game, the glass cold plates between the drawers can be removed.

- Pull out the drawers as far as they will go, and then lift them up and out.
- Lift the glass plate slightly, pull it forwards and out.

## Using accessories

### Making ice cubes

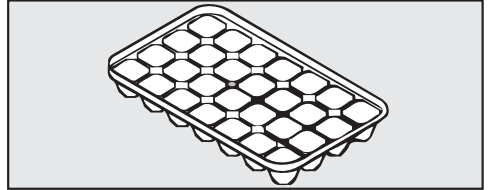

- Fill the ice cube tray three quarters full with water and place it on the bottom of one of the freezer drawers.
- Once frozen, use a blunt instrument, for example a spoon handle, to remove the ice tray from the freezer if it is stuck.

**Tip:** Ice cubes can be removed easily from the tray by holding it under running water for a short time.

## Freezer

The freezer does not defrost automatically.

In normal use, ice and frost will form in the freezer, e.g. on the internal walls. How much ice and frost accumulates in the appliance will depend on the following:

- Whether the freezer door has been opened frequently or left open for a while.
- Whether a large quantity of food has been placed in the freezer at once.
- Whether the humidity in the room has increased.

Too thick a layer of ice will make it hard to remove freezer drawers, and in certain circumstances can prevent the freezer door from closing properly. Too thick a layer of ice also reduces cooling performance and thus increases energy consumption.

- The freezer should be defrosted from time to time. It must be defrosted if a layer of ice approx. 0.5 cm thick has accumulated.

**Tip:** It is best to defrost when only very few or no frozen goods at all are left in the freezer or the humidity level and the ambient temperature in the room are low.

 Risk of damage from an incorrect defrosting process.

When defrosting the freezer, make sure that you do not damage the evaporator as this would cause irreversible damage to the refrigeration appliance.

Do not scrape off ice and frost. Do not use sharp objects.

Do not use any mechanical or other types of aids which are not recommended by the manufacturer to accelerate the defrosting process.

## Before defrosting

- Switch on the SuperFreeze function one day before defrosting. This helps the frozen goods to retain the cold reserve for longer when taken out of the freezer.
- Remove the frozen goods and wrap them in several layers of newspaper or cloths.

**Tip:** You could also place the frozen goods in a cool box or bag.

- Store the frozen goods in a cool place until the freezer is ready for use again.
- Remove all the freezer drawers and glass cold plates (depending on the model) from the freezer.

# Defrosting

## To defrost

The longer the frozen goods are left out at room temperature, the faster they deteriorate.

Carry out the defrosting procedure as quickly as possible.

 Risk of damage due to heat and moisture ingress.

The steam from a steam cleaner as well as electric heaters and candles can damage plastic and electrical components.

Do not use a steam cleaner, electric heaters or candles to defrost the refrigeration appliance.

Defrosting sprays or de-icers can contain substances which could damage the plastic parts or which might cause a build-up of explosive gases and pose a danger to health. Do not use defrosting sprays or de-icers.

Ensure that water does not get into the surrounding cabinetry.

- Switch the refrigeration appliance off.

The cooling system will be switched off.

- Switch off at the wall and withdraw the plug from the socket, or disconnect the fuse.
- Leave the freezer door open.

**Tip:** To speed up defrosting, place two bowls of hot water (not boiling), with plates underneath them, in the freezer. Closing the door in this instance will help retain the warmth and speed up the defrosting process.

- Remove any loose pieces of ice.
- Use a sponge or towel to soak up the defrosted water as often as necessary.

## After defrosting

- Clean the freezer, then dry it thoroughly.
- Close the appliance doors.
- Reconnect to the mains and switch the refrigeration appliance back on.
- Switch on the SuperFreeze function so that the freezer can cool down quickly.
- Once the temperature in the freezer has reached the required temperature, place the frozen goods back in the freezer drawers and put them back in the freezer.
- As soon as the freezer zone reaches a constant temperature of at least  $-18\text{ }^{\circ}\text{C}$ , press the SuperFreeze button to turn off the function.

Do not let water get into the electronic unit.

 Risk of damage due to moisture ingress.

The steam from a steam cleaner can damage plastic and electrical components.

Do not use a steam cleaner to clean the refrigeration appliance.

The data plate located inside the interior cabinet of the refrigeration appliance must not be removed. It contains information which is required in the event of a fault.

## Cleaning agents

Cleaning and conditioning agents used inside the appliance must be food safe.

To avoid damaging all the surfaces of your appliance, **do not use:**

- cleaning agents containing soda, ammonia, acids or chlorides
- cleaning agents containing descaling agents
- abrasive cleaning agents, e.g. powder cleaners and cream cleaners
- solvent-based cleaning agents
- stainless steel cleaning agents
- dishwasher cleaner
- oven sprays
- glass cleaning agents
- hard, abrasive sponges and brushes, e.g. pot scourers
- melamine eraser blocks
- sharp metal scrapers

We recommend using a clean sponge, lukewarm water with a little washing-up liquid to clean surfaces of the appliance.

The following pages contain important information on cleaning.

# Cleaning and care

## Preparing the appliance for cleaning

- Switch the appliance off.
- Disconnect the appliance from the mains. Switch off at the wall and withdraw the plug from the socket, or switch off the mains fuse board.
- Take any food out of the appliance and store it in a cool place.
- Defrost the freezer section (see “Defrosting”).
- Take out all other removable parts for cleaning.

## Cleaning the interior and accessories

The refrigeration appliance should be defrosted and cleaned regularly, or at least twice a year.

Remove soiling immediately to prevent it from drying on.

The best time to do so is when:

- There is very little or no frozen food left in the freezer zone.
- The humidity level in the room is low and the ambient temperature in the room is also low (cooler part of the year).
- Clean the **interior** with a clean sponge, lukewarm water and a little washing-up liquid.
- After cleaning, wipe with clean water and dry with a soft cloth.

- Leave the door open to air the appliance for a short while and to prevent odours building up.

The following parts **cannot be cleaned in a dishwasher**:

- the freezer drawers
- the shelves
- These accessories should all be hand washed.

The ice cube tray is **dishwasher-safe**.

 Risk of damage as a result of excessively high dishwasher temperatures.

Parts of the refrigeration appliance may become unusable, e.g. deform, if they are washed in the dishwasher at more than 55 °C.

For dishwasher-safe parts, only use dishwasher programmes with a maximum temperature of 55 °C.

Contact with natural dyes from carrots, tomatoes and ketchup, etc., may discolour the plastic parts in the dishwasher. This discolouration does not affect the stability of the parts.

## Cleaning the front of the appliance and the side panels

If soiling is left on for any length of time, it may become impossible to remove. Surfaces may suffer discolouration or damage.

Therefore, it is best to remove soiling from the appliance front and side panels immediately.

All surfaces are susceptible to scratching. Contact with unsuitable cleaning agents can alter or discolour the surfaces.

See the information on “Cleaning agents” at the beginning of this section.

- Clean the surfaces with a clean sponge and a solution of warm water and washing-up liquid. A clean, damp microfibre cloth without cleaning agent can also be used.
- After cleaning, wipe with clean water and dry with a soft cloth.

## Cleaning the door seal

 Risk of damage as a result of incorrect cleaning.

If you treat the door seal with oils or grease, it can become porous. Do not use any oils or grease on the door seal.

- The door seal should be cleaned regularly with clean water and then wiped dry with a cloth.

## Cleaning the ventilation gaps

A build-up of dust will increase the energy consumption of the appliance.

- The ventilation gaps should be cleaned on a regular basis with a brush or vacuum cleaner (you could use a Miele vacuum cleaner dusting brush, for example).

## Cleaning the compressor and metal grille at the back of the appliance

A build-up of dust will increase the energy consumption of the appliance.

 Risk of damage as a result of incorrect cleaning.

Cables and other components can get broken off, bent or damaged. Carefully clean the compressor and metal grille.

The compressor and metal grille at the back of the refrigeration appliance (heat exchanger) should be dusted at least once a year.

## After cleaning

- Close the appliance door.
- Reconnect to the mains and switch the appliance back on.
- Switch on the Super freeze function so that the appliance can cool down quickly.
- Once the temperature in the freezer is sufficiently low, place the food back in the freezer drawers and put them back in the freezer.
- Switch the Super freeze function off.

## Problem solving guide

---

Many malfunctions and faults that can occur in daily operation can be easily remedied. Time and money will be saved because a service call will not be needed.

The following guide may help you to find the reason for a malfunction or a fault, and to correct it.

To prevent unnecessary loss of temperature it is advisable not to open the door while waiting for the appliance to be serviced.

Problem	Cause and remedy
<b>The appliance does not get cold and the temperature display is not lit up.</b>	The appliance has not been switched on. ■ Switch the appliance on.
	The plug is not inserted in the socket correctly. ■ Insert the plug into the socket correctly and switch on.
	Check whether the mains fuse has tripped. There could be a fault with the appliance, the household electrical wiring or another electrical appliance. ■ Contact a qualified electrician or Miele Service.
<b>The compressor runs continuously.</b>	This is not a fault. To save energy, the compressor runs at a lower speed, but for longer, when less cooling is required.





## Problem solving guide

Problem	Cause and remedy
<p><b>The compressor is switching on more frequently and for longer periods of time. The temperature in the refrigeration appliance is too low.</b></p>	<p>The ventilation gaps in the housing unit have been covered or become too dusty.</p> <ul style="list-style-type: none"> <li>■ Do not block the ventilation gaps.</li> <li>■ Dust the ventilation gaps regularly.</li> </ul>
	<p>The appliance door has been opened too frequently, or a large amount of fresh food has been placed inside or frozen at the same time.</p> <ul style="list-style-type: none"> <li>■ Only open the appliance door when necessary and for as short a time as possible.</li> </ul> <p>After a while, the temperature will return to normal by itself.</p>
	<p>The appliance door is not properly closed. A thick layer of ice may have formed in the freezer zone.</p> <ul style="list-style-type: none"> <li>■ Close the appliance door.</li> </ul> <p>After a while, the temperature will return to normal by itself.</p> <p>If a thick layer of ice has already formed, this will affect cooling and increase energy consumption.</p> <ul style="list-style-type: none"> <li>■ Defrost the refrigeration appliance and clean it.</li> </ul>
	<p>The ambient room temperature is too high. The higher the ambient temperature, the longer the compressor has to run.</p> <ul style="list-style-type: none"> <li>■ See the information in “Location” in “Installation”.</li> </ul>
	<p>The refrigeration appliance was not properly installed in the niche.</p> <ul style="list-style-type: none"> <li>■ See the information in “Installation” and “Installing the refrigeration appliance”.</li> </ul>
	<p><b>The compressor is switching on more frequently and for longer periods of time, so the temperature in the appliance is dropping.</b></p>
<p>The Super freeze function is still switched on.</p> <ul style="list-style-type: none"> <li>■ You can switch off the Super freeze function earlier to save energy.</li> </ul>	

## Problem solving guide

Problem	Cause and remedy
<p><b>The compressor comes on less and less often and for shorter periods of time. The temperature in the refrigeration appliance rises.</b></p>	<p>This is not a fault. The temperature setting is too high.</p> <ul style="list-style-type: none"> <li>■ Correct the temperature setting.</li> <li>■ Check the temperature again after 24 hours.</li> </ul> <p>The frozen food begins to defrost. The room temperature is too low for this refrigeration appliance. If the room temperature is too low, the compressor will run less frequently. This may cause the freezer zone to become too warm.</p> <ul style="list-style-type: none"> <li>■ See the information in “Installation” – “Location”.</li> <li>■ Increase the temperature of the room.</li> </ul>
<p><b>An LED indicator light is flashing at the back of the refrigeration appliance at the bottom near the compressor (depending on model). The electronic unit for the compressor is equipped with an operation and fault diagnosis LED indicator light.</b></p>	<p>The indicator light flashes several times every 5 seconds. A fault has occurred.</p> <ul style="list-style-type: none"> <li>■ Call the Miele Customer Service Department.</li> </ul> <p>The indicator light flashes regularly every 15 seconds. Not a fault. This flashing is normal.</p>

## Display warnings

Message	Cause and remedy
The  symbol lights up in the display. You cannot switch the appliance off.	<p>The <b>safety lock</b> has been activated.</p> <ul style="list-style-type: none"> <li>■ Completely deactivate the safety lock (see “Selecting further settings – Activating and deactivating the safety lock”).</li> </ul>
The alarm symbol  and the temperature display are flashing.	<p>The temperature in the appliance is too warm or too cold.</p> <p>Possible reasons for this include:</p> <ul style="list-style-type: none"> <li>– The appliance door has been opened too frequently.</li> <li>– A large quantity of fresh food has been placed in the freezer without switching on the Super-Freeze function.</li> <li>– A prolonged power cut (mains outage) has occurred.</li> </ul> <ul style="list-style-type: none"> <li>■ Rectify the cause of the alarm. The alarm symbol  will go out.</li> </ul> <p>Depending on the temperature displayed, you should check whether food in the freezer has started to thaw or has defrosted. If it has, it should be used as soon as possible. Defrosted food may only be re-frozen after it has been cooked.</p>
The  symbol and the temperature display are flashing.	<p>This indicates an <b>appliance fault</b>:</p> <ul style="list-style-type: none"> <li>■ Call Service.</li> </ul>
The  symbol lights up in the display, the appliance does not get cold, although the appliance controls are working.	<p>Demo mode is switched on. This allows the appliance to be presented in the showroom without the cooling system being switched on. Do not activate this setting for domestic use.</p> <ul style="list-style-type: none"> <li>■ Contact the Miele Service Department for information on deactivating Demo mode.</li> </ul>

# Problem solving guide

---

## Other problems

Problem	Cause and remedy
<b>Food has frozen together.</b>	The food packaging was not dry when placed in the freezer. ■ Use a blunt instrument, e.g. a spoon handle or plastic scraper, to prise it apart carefully.
<b>The external walls of the appliance feel warm.</b>	This is not a fault. The heat created by the evaporator is used to prevent condensation.

Normal noises	What causes them
<b>Brrrrr ...</b>	A humming noise is made by the motor (compressor). This noise can get louder for brief periods when the motor switches on.
<b>Blubb, blubb ...</b>	A gurgling noise can be heard when coolant is circulating through the pipes.
<b>Click ...</b>	Clicking sounds are made when the thermostat switches the motor on and off.
<b>Crack ...</b>	A cracking sound can be heard when materials expand inside the appliance.
Remember that the noise of the compressor and the coolant circulating in the system is unavoidable.	

Noises	Cause and remedy
<b>Rattling, vibrating</b>	The appliance is uneven. Realign the appliance using a spirit level. Do so by raising or lowering the screw feet underneath the appliance or place something underneath it.
	The appliance is touching another appliance or piece of furniture. Move it away.
	Drawers or shelves are unstable or sticking. Check all removable items and refit them correctly.
	Bottles or containers are touching each other. Separate them.
	The transport cable clips are hanging loose at the back of the appliance. Remove them.

# Service

## Contact in the event of a fault

In the event of any faults which you cannot remedy yourself, please contact your Miele dealer or the Miele Customer Service Department.

You can book a Miele Customer Service Department call-out online at [www.miele.com/service](http://www.miele.com/service).

Contact information for the Miele Customer Service Department can be found at the end of this document.

Please quote the model identifier and serial number of your appliance (Fabr./SN/Nr.) when contacting the Miele Customer Service Department. This information can be found on the data plate.

Please note that telephone calls may be monitored and recorded for training purposes and that a call-out charge will be applied to service visits where the problem could have been resolved as described in this booklet.

The data plate can be found inside the appliance.

## EPREL database

From 1 March 2021, information on energy labelling and ecodesign requirements will be available in the European Product Database (EPREL). You can find the product database at the following link <https://eprel.ec.europa.eu/>. You will be asked to enter the model identifier.

The model identifier can be found on the data plate.



XXXXXX
Nr. XX/XXXXXXXXXX

WEINTEMPERATURSCHRANK-INTERTECHSCHICHEL  
 MULTITEMPERATURE WINE STORAGE CABINET-UNDERA/WORKTOP  
 ARMOIRE DE MISE EN TEMPERATURE WINE/MACCO, ENCASTRABLE SOUS PLAN  
 ARMARIO DE PLACACION MUITO, VINOS/MODER POTRABAJU EN OMIERA  
 БИРНИКЪТЕМПЕРАТУРАТА НА ВИНОТО

Klasse/Class Classe/Classe SN-ST	Ap-Type/AP-Type AP-Type/AP-Type	Bruttinhalt/Brut Capacity Volume Brut/Capacitad Bruta XXXX l	Gefriervermögen/Freezing Capacity Pouvoir de Congel/Capac. Congeladora
--	------------------------------------	--	---

Nutzinhalt Net Capacity Volume Ut Capac. Util	Ges Tot To	/K /R /R	/G /F /C	/WEIN /KALT /WINE /CHILL	<b>R600a: XXg</b>
--	------------------	----------------	----------------	-----------------------------	-------------------

## Warranty

The appliance warranty is valid for 2 years from date of purchase. In the UK, you must activate your cover by calling 0330 160 6640 or registering online at [www.miele.co.uk](http://www.miele.co.uk).

For more information on country-specific warranty terms and conditions, please contact Miele Customer Service.

## Installation

 Fire risk and danger of damage from appliances which give off heat. Appliances which give off heat can catch fire and set fire to the refrigeration appliance.  
Do not place appliances which give off heat, such as mini-ovens, double burner hobs or toasters on the refrigeration appliance.

 Fire risk and danger of damage from open flames. Open flames can set fire to the refrigeration appliance.  
Keep open flames (e.g. a candle) away from the refrigeration appliance.

## Side-by-side combinations

As a general rule, refrigeration appliances should not be installed vertically or horizontally next to other such appliances so as to avoid a build-up of condensation between them and the damage this can cause.

Your refrigeration appliance must not be installed next to another refrigeration appliance (“side-by-side”), or above another one, because it is not equipped with built-in heating units in the side panels.

It can, however, be installed next to another refrigeration appliance with built-in heating as long as they are in separate niches. Please contact your Miele retailer to find out which appliances are suitable for this method of installation.

## Location

This appliance should be installed in a dry, well-ventilated room.

When deciding where to install your refrigeration appliance please bear in mind that it will use more energy if installed near to a heater, a cooker or other appliance that gives off heat. Direct sunlight should also be avoided. The higher the room temperature, the longer the compressor runs and the higher the energy consumption is.

When installing the appliance, please note:

- The socket must be easily accessible in an emergency, not concealed behind the appliance.
- The plug and cable must not touch the rear of the appliance as they could be damaged by vibrations from the appliance.
- Do not plug in other appliances behind this appliance.

# Installation

 Risk of damage due to condensation on external appliance panels. In environments with high humidity, condensation can build up on external appliance panels, which can cause corrosion.

To prevent this, it is advisable to install the refrigeration appliance in a dry and/or air-conditioned room with sufficient ventilation.

After installation, make sure that the appliance door closes properly, that the specified ventilation gaps are adhered to, and that the refrigeration appliance has been installed in accordance with these installation instructions.

## Climate range

This refrigeration appliance is designed for use within specific ambient temperatures (climate range). Do not use in ambient temperatures for which it is not designed.

A lower room temperature leads to the compressor switching off for longer periods. This can cause the internal temperature in the refrigeration appliance to rise with the risk of food deteriorating and going off.

The climate range is stated on the data plate in the interior cabinet of the refrigeration appliance.

<b>Climate range</b>	<b>Ambient room temperature</b>
SN, N	Up to +32 °C
ST	Up to +38 °C
T	Up to +43 °C

A freezer from the SN climate range can operate without any difficulties in rooms with a cooler ambient temperature (down to -15 °C).

## Ventilation

 Risk of fire and damage due to insufficient ventilation.

If the refrigeration appliance is not ventilated sufficiently, the compressor will run more frequently and for longer periods. This will result in increased energy consumption and a higher operating temperature for the compressor. This may, in turn, cause damage to the compressor.

Please ensure that there is adequate ventilation around the refrigeration appliance.

It is essential to observe the ventilation gaps given. The ventilation gaps must not be covered or blocked in any way.

Air at the back of the refrigeration appliance gets warm.

## Appliances supplied with wall spacers

The wall spacers supplied with some appliances must be used in order to achieve declared energy consumption values. Appliance depth is increased by approx. 35 mm with the wall spacers fitted. If the wall spacers are not used the functionality of the appliance is not affected. Energy consumption is only slightly increased with less distance between the appliance and the wall.

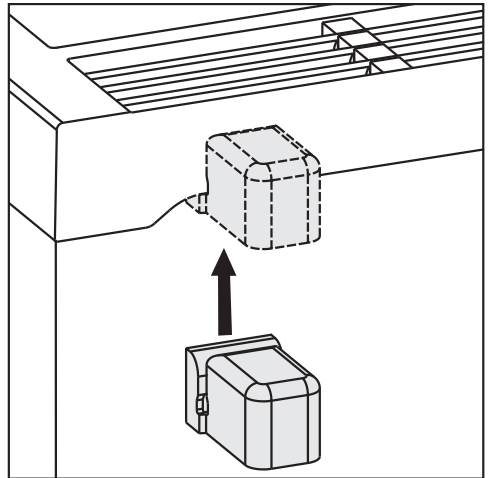

- Fit the wall spacers onto the back of the appliance on the top left and right.

# Installation

## Installing the appliance

⚠ Two people are required for installing the appliance.

⚠ The appliance must be empty before it is moved.

- **Do not under any circumstances remove** the pouches (depending on model) located between the back of the appliance and the metal grille (heat exchanger). These are important for the correct functioning of the appliance. Their contents are non-toxic and are not dangerous.
- Release the mains cable from the back of the appliance.
- Remove the cable clip from the back of the appliance.
- Carefully push the appliance into position.
- Position the appliance with the wall spacers (if fitted) or the back of the appliance against the wall.

## Aligning the appliance

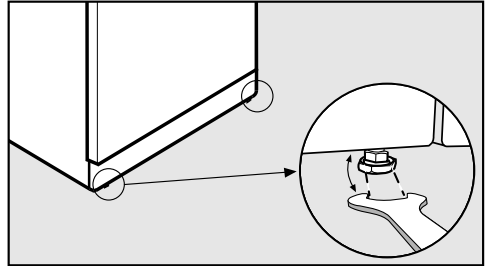

- To align the appliance, adjust the front feet using the spanner supplied

## Installing the refrigeration appliance in a run of kitchen units

 Risk of fire and damage due to insufficient ventilation.

If the refrigeration appliance is not ventilated sufficiently, the compressor will run more frequently and for longer periods. This will result in increased energy consumption and a higher operating temperature for the compressor. This may, in turn, cause damage to the compressor.

Please ensure that there is adequate ventilation around the refrigeration appliance.

It is essential to observe the required ventilation gaps. The ventilation gaps must not be covered or blocked in any way.

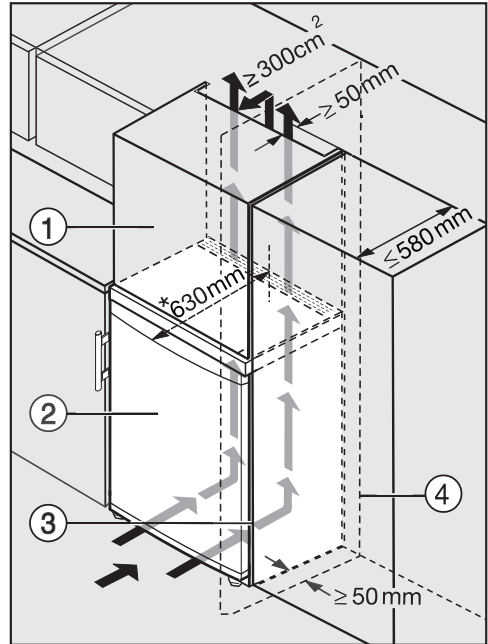

- ① Top box
- ② Refrigeration appliance
- ③ Housing unit
- ④ Wall

\* The appliance depth is increased by approx. 35 mm for refrigeration appliances with wall spacers fitted.

The refrigeration appliance can be built into any run of kitchen units and installed directly next to a kitchen furniture housing unit. The appliance front must protrude in front of furniture fronts by at least 34 mm\* at the sides and by at least 55 mm\* in the middle. This enables the appliance door to be opened and shut without being obstructed. To match the height of the rest of the kitchen units, the refrigeration appliance can be fitted with a suitable top box ①.

# Installation

---

When installed next to a wall ④, a distance of at least 50 mm must be maintained on the hinge side between the wall ④ and the refrigeration appliance ②. This equates to the distance that the handle protrudes by when the door is open.

The larger the ventilation gap, the more economically the compressor will work.

- A ventilation gap of at least 50 mm depth must be provided at the back of the refrigeration appliance behind the whole width of the top box for air to circulate.
- The ventilation gap under the ceiling must be at least 300 cm<sup>2</sup> to ensure that warm air can escape without obstruction.

## Appliance dimensions

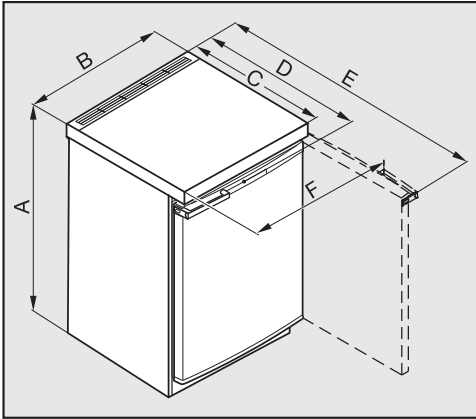

	<b>A</b> [mm]	<b>B</b> [mm]	<b>C</b> [mm]	<b>D</b> [mm]	<b>E</b> [mm]	<b>F</b> [mm]
<b>F 12011 S-2</b>	850	554	610*	623	1129	601
<b>F 12011 S-3</b>	850	554	610*	623	1129	601

\* Dimensions without wall spacers fitted. The appliance depth is increased by 35 mm with the wall spacers supplied fitted.

# Installation

## Changing the door hinging

The refrigeration appliance is supplied with hinges on the right. If left-hand hinging is required, the hinges must be changed.

- Place a suitable cover on the floor in front of the appliance to protect the appliance door and your floor from damage.

If a door seal is damaged the appliance door will not close properly and cooling performance will be reduced. As a result, condensate will build up in the interior cabinet and this can cause a build-up of ice. Do not damage the door seal.

- Close the appliance door.

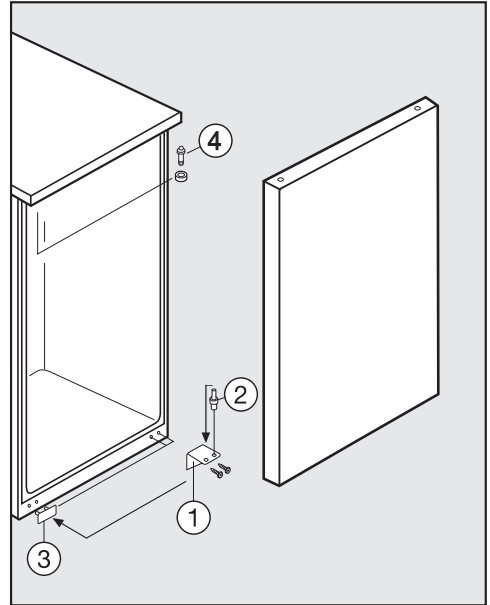

- Unscrew the bottom hinge bracket ①, and take it off.
- Take the appliance door off downwards.
- Pull the hinge pin ② out of the hinge bracket ①, and screw it into the second hole in the hinge bracket. (The hinge pin can be removed and screwed back in using the hexagon key supplied.)
- Remove cover ③ and use it to cover the empty holes on the opposite side.
- Unscrew the upper hinge pin ④ with the hexagon key supplied and refit it on the opposite side. Don't forget to use the washer.

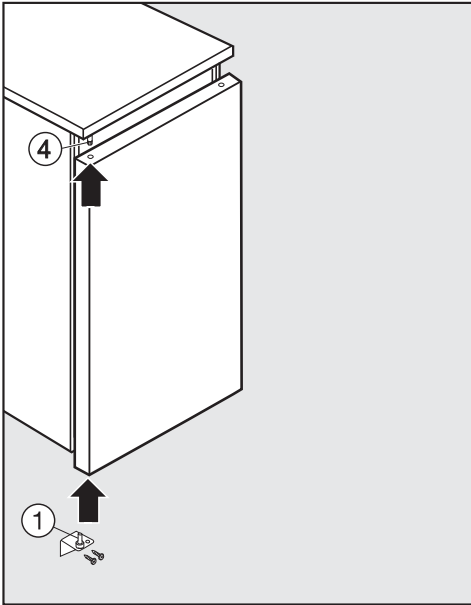

- Fit the appliance door from below up onto the upper hinge pin (4) and then close the appliance door.
- Fit the hinge bracket (1) from below into the lower door bearing and screw it on tight.
- The appliance door can be aligned using the long slots in the hinge bracket. Ensure that all screws have been properly tightened.

## Changing over the door handle

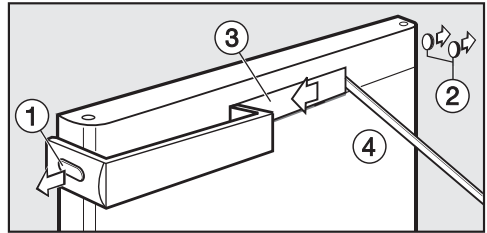

- Carefully remove the cap (1) and stoppers (2) from the sides.

Be careful not to let the tool slip out and damage the appliance surface.

- Slide the cover (3) over to the left and then insert a suitable plastic or wooden tool (4) into the gap on the right hand side.
- Carefully lever the cover (3) off.

# Installation

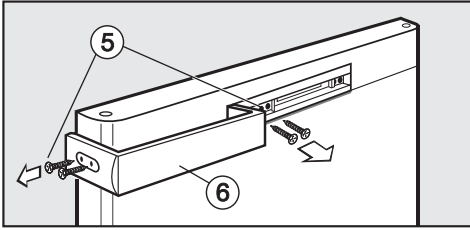

- Loosen the screws ⑤ from the handle side and in the middle and then take the handle ⑥ off.

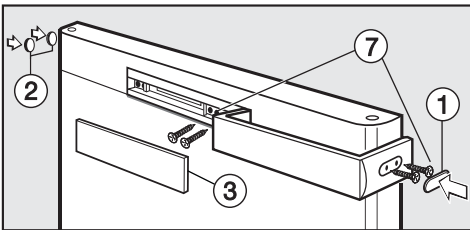

- Turn the handle 180° and refit it on the opposite side.
- First screw in at the side and then in the middle ⑦.
- Refit the cap ① and stoppers ② on the opposite side.
- Refit the middle cover ③ by pressing it in, first on the left-hand side and then on the right-hand side.

## Electrical connection

The appliance is supplied with a mains cable and moulded plug ready for connection to an AC single-phase 220–240 V 50 Hz supply.

The fuse rating must be at least 10 A.

This appliance must be connected to a suitable switched socket. The electrical installation must be in compliance with current local and national safety regulations, (e.g. VDE 0100 in Germany / BS 7671 in the UK). We recommend the use of a suitable RCD .

The socket must not be concealed behind the appliance and must be easily accessible so that the appliance can be quickly disconnected from the electrical supply in case of an emergency.

If the socket is no longer accessible after installation, an additional means of disconnection must be provided for all poles. Suitable means of disconnection include switches with an all-pole contact gap of at least 3 mm. These include miniature circuit breakers, fuses and contactors (EN 60335).

The mains plug and mains connection cable must not come into contact with the back of the appliance as vibrations can cause damage to these components. This could result in a short circuit.

Do not plug in other appliances behind this appliance.

Do not connect the appliance to the mains electricity supply by an extension lead. Extension leads do not guarantee the required safety of the appliance (e.g. danger of overheating).

Do not connect the appliance to a stand-alone inverter such as those used with an autonomous energy source e.g. **solar power**.

When the appliance is switched on, power surges could result in a safety switch-off. This could damage the electronic module. The appliance must not be used with so-called **energy saving devices** either. These reduce the amount of energy supplied to the appliance, causing it to overheat.

If the mains cable needs to be replaced, this must be performed by a qualified electrician.



## United Kingdom

Miele Co. Ltd., Fairacres, Marcham Road, Abingdon, Oxon, OX14 1TW

Tel: 0330 160 6600, Internet: [www.miele.co.uk/service](http://www.miele.co.uk/service), E-mail: [info@miele.co.uk](mailto:info@miele.co.uk)

### Australia

Miele Australia Pty. Ltd.  
ACN 005 635 398  
ABN 96 005 635 398  
1 Gilbert Park Drive  
Knoxfield, VIC 3180  
Tel: 1300 464 353  
Internet: [www.miele.com.au](http://www.miele.com.au)

### China

Miele (Shanghai) Trading Ltd.  
1-3 Floor, No. 82 Shi Men Yi Road  
Jing' an District  
200040 Shanghai, PRC  
Tel: +86 21 6157 3500  
Fax: +86 21 6157 3511  
E-mail: [info@miele.cn](mailto:info@miele.cn),  
Internet: [www.miele.cn](http://www.miele.cn)

### Miele (Hong Kong) Limited

41/F - 4101, Manhattan Place  
23 Wang Tai Road  
Kowloon Bay, Hong Kong  
Tel: (852) 2610 1025  
Fax: (852) 3579 1404  
Email:  
[customerservices@miele.com.hk](mailto:customerservices@miele.com.hk)  
Website: [www.miele.hk](http://www.miele.hk)

### India

Miele India Pvt. Ltd.  
Ground Floor  
Copia Corporate Suites  
Plot No. 9, Jasola  
New Delhi - 110025  
Tel: 011-46 900 000  
Fax: 011-46 900 001  
E-mail: [customercare@miele.in](mailto:customercare@miele.in)  
Internet: [www.miele.in](http://www.miele.in)

### Ireland

Miele Ireland Ltd.  
2024 Bianconi Avenue  
Citywest Business Campus  
Dublin 24  
Tel: (01) 461 07 10  
Fax: (01) 461 07 97  
E-Mail: [info@miele.ie](mailto:info@miele.ie)  
Internet: [www.miele.ie](http://www.miele.ie)

### Malaysia

Miele Sdn Bhd  
Suite 12-2, Level 12  
Menara Sapura Kencana  
Petroleum  
Solaris Dutamas No. 1  
Jalan Dutamas 1  
50480 Kuala Lumpur, Malaysia  
Phone: +603-6209-0288  
Fax: +603-6205-3768

### New Zealand

Miele New Zealand Limited  
IRD 98 463 631  
8 College Hill  
Freemans Bay, Auckland 1011  
New Zealand  
Tel: 0800 464 353  
Internet: [www.miele.co.nz](http://www.miele.co.nz)

### Singapore

Miele Pte. Ltd.  
163 Penang Road  
# 04 - 03 Winsland House II  
Singapore 238463  
Tel: +65 6735 1191  
Fax: +65 6735 1161  
E-Mail: [info@miele.com.sg](mailto:info@miele.com.sg)  
Internet: [www.miele.sg](http://www.miele.sg)

### South Africa

Miele (Pty) Ltd  
63 Peter Place, Bryanston 2194  
P.O. Box 69434, Bryanston 2021  
Tel: (011) 875 9000  
Fax: (011) 875 9035  
E-mail: [info@miele.co.za](mailto:info@miele.co.za)  
Internet: [www.miele.co.za](http://www.miele.co.za)

### Taiwan

K.E. & Kingstone Co., Ltd.  
6th Fl., No. 120, Sec. 2  
Jianguo N. Rd.  
Taipei, Taiwan  
TEL: +886 2 2502-7256  
FAX: +886 2 2502-3077  
E-mail: [kenk@kenk.com.tw](mailto:kenk@kenk.com.tw)  
Website:  
[www.kenk.com.tw/ke/miele](http://www.kenk.com.tw/ke/miele)

### Thailand

BHIRAJ TOWER at EmQuartier  
43rd Floor Unit 4301-4303  
689 Sukhumvit Road  
North Klongton Sub-District  
Vadhana District  
Bangkok 10110, Thailand

### United Arab Emirates

Miele Appliances Ltd.  
Showroom 1  
Eiffel 1 Building  
Sheikh Zayed Road, Umm Al Sheif  
P.O. Box 114782 - Dubai  
Tel. +971 4 3044 999  
Fax. +971 4 3418 852  
800-MIELE (64353)  
E-Mail: [info@miele.ae](mailto:info@miele.ae)  
Website: [www.miele.ae](http://www.miele.ae)

**Manufacturer:** Miele & Cie. KG, Carl-Miele-Straße 29, 33332 Gütersloh, Germany

F 12011 S-1, F 12011 S-2

en-GB

M.-Nr. 09 290 830 / 04