



Operating Instructions

2400W Ceramic Wall Heater



Model: GCW240

General Care and Safety Guide

YOUR SAFETY IS IMPORTANT TO US. PLEASE ENSURE YOU TAKE NOTE OF THE INSTRUCTIONS AND WARNINGS OUTLINED IN THIS MANUAL.

CAUTION: In order to avoid a hazard due to inadvertent resetting of the thermal cut-out, this appliance must not be supplied through an external switching device, such as a timer, or connected to a circuit that is regularly switched on and off by the utility.

- This appliance is not intended for use by persons (including children) with reduced physical, sensory or mental capabilities or lack of experience and knowledge, unless they are supervised or have been given instruction concerning the use of the appliance by a person responsible for their safety.
- Children should be supervised to ensure that they do not play with the appliance.
- If the supply cord is damaged, it must be replaced by the manufacturer, its service agent or similarly qualified persons in order to avoid a hazard.

WARNING: You must not cover this appliance. Covering this appliance presents fire risk and will activate the safety fuse; permanently disabling the unit.

WARNING: Do not use this appliance in small rooms when they are occupied by persons not capable of leaving the room on their own, unless constant supervision is provided.

WARNING: To reduce the risk of fire, keep textiles, curtains, or any flammable material a minimum distance of 1 metre from the air outlet.

- Use only the voltage specified on the rating label of the appliance.
- Keep all objects at least 1 metre from the front and sides of the appliance.
- This appliance is intended for household use only and not for commercial or industrial use.
- Indoor use only.
- Use this appliance only as described in this manual. Any other use is not recommended by the manufacturer and may cause fire, electric shock or injury.
- Do not use the appliance if it has been dropped or damaged.
- The common cause of overheating is deposits of dust or fluff in the appliance. Ensure these deposits are removed regularly by unplugging the appliance and vacuum cleaning the air vents and grills.

General Care and Safety Guide

- Never use the appliance to dry clothes.
- Always unplug appliance when not in use.
- When the appliance has been unpacked, check it for transport damage and ensure all parts have been delivered. If parts are missing or the appliance has been damaged, contact the Customer Services Team.
- Do not use if there are visible signs of damage to the appliance.
- Do not connect the appliance to mains supply until completely assembled and adjusted.
- Ensure hands are dry before handling the plug or main unit.
- Ensure appliance is on a flat, stable, heat-resistant surface.
- Do not operate with cord set coiled up as a heat build up is likely, which could be sufficient to become a hazard.
- Carry out regular checks of the supply cord to ensure no damage is evident
- Do not operate this appliance with a damaged cord, plug or after the appliance malfunctions or has been dropped or damaged in any manner. Take to a qualified electrical person for examination, electrical service or repair.
- Do not twist, kink or wrap the cord around the appliance, as this may cause the insulation to weaken and split. Always ensure that all cord has been removed from any cord storage area and is unrolled before use.
- It is recommended that this appliance is plugged directly into the wall socket. Power boards are not rated to supply power to high wattage appliances.
- A correctly specified, undamaged extension cord may be used with this appliance provided it is used in a safe manner.
- Do not remove plug from power socket until the appliance has been switched off.
- Do not remove plug from power socket by pulling cord; always grip plug.
- Don't place appliance on bedding or on thick & long carpet where the openings may get blocked.
- Switch off and use handle provided when moving
- Do not place appliance close to radiant heat source.
- Do not insert or allow foreign objects to enter any ventilation or exhaust opening, as this may cause an electric shock, fire or damage to the appliance.
- Do not sit on the appliance.
- Do not use abrasive cleaning products on this appliance. Clean with a damp cloth (not wet) rinsed in hot soapy water only. Always remove plug from the mains supply before cleaning.
- Do not operate in areas where petrol, paint or other flammable liquids are used or stored.
- Do not use this appliance in the immediate surrounds of a bath, a shower, or a swimming pool or other liquids.

General Care and Safety Guide

- The appliance must not be immersed in any liquids.
- There are no user serviceable parts installed in the unit.
- Do not place the unit in wardrobes or other enclosed spaces as this may cause fire hazards.
- This unit is not supposed to be used in or around locations where foodstuffs, works of art or delicate articles of science, etc. are stored.
- If your appliance does not work, or is not working properly, contact the place of purchase or the Customer Services Team.

The remote control supplied with this appliance uses a **CR2025** coin type battery.

DANGER IF SWALLOWED

- Keep batteries out of reach of children. Swallowing may lead to serious injury or death in as little as 2 hours due to internal burns.
- If swallowed, go straight to a hospital emergency room.
- Dispose of used batteries immediately.

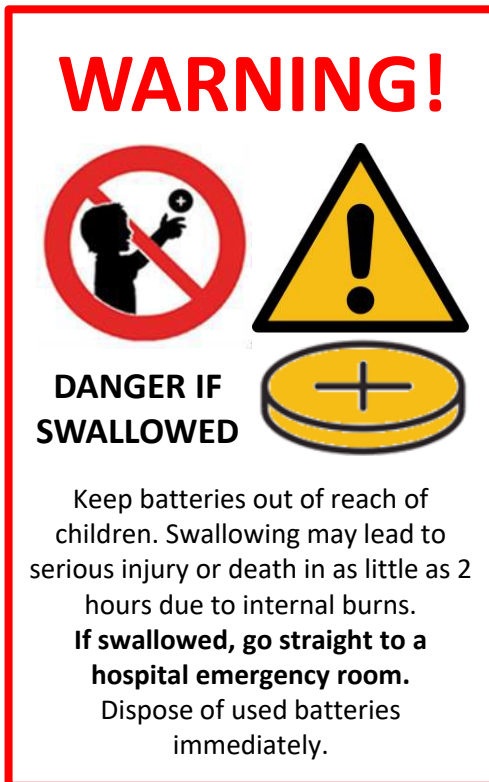

Components



Main Unit x 1



Remote x 1



Screw Pack:
Screws x 2
Wall plugs x 2

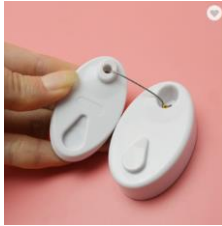

Remote Control Toggle x 1
(to attached to wall)

Installing your Appliance

Before using this appliance, it must be wall mounted.

NOTE: Your Goldair Ceramic Wall Heater should be installed with at least 1.8m clearance from the floor at least 300mm clearance from the ceiling and 200mm clearance from any other surrounding parts including other appliances, side walls, shelves and soft furnishings.

NOTE: Do not run the power cord behind the heater.

WALL MOUNTED HEATERS ARE ONLY TO BE MOUNTED ON HEAT RESISTANT WALLS THAT COMPLY WITH CURRENT AS/NZS SPECIFICATIONS & BUILDING REGULATIONS

Installing your Appliance

Always choose a safe location for the heater, keeping in mind the safety precautions outlined. Ensure all packaging has been removed from the unit before use.

CAUTION: Do not mount directly under or over an electrical power socket. It is recommended to install the heater to the side of the power socket.

The cord length is 1.5m, an electrician may be required to install a power socket nearer to the appliance.

LOCATION

The heater should be placed with a minimum distance of 1 metre between the unit and flammable objects such as curtains, paintings or other materials that may pose fire risk. Installation of the heater on the wall **MUST BE** 1.8m above the floor to the bottom of the heater, 300mm from the ceiling to the top of the heater and 200mm away from closest side walls.

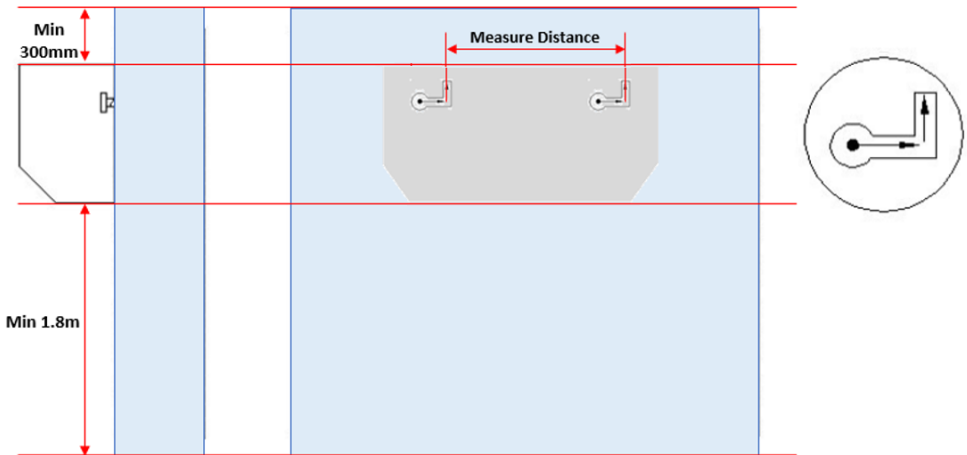

INSTALLATION

1. Measure the distance between the mounting holes on the back of the appliance and then mark the wall at the measured distance. Ensure that the marks you make are level.
2. Drill holes to the same diameter as the wall plugs.
3. Place the wall plugs into the hole in the wall and then fix two screws into the wall plugs.
4. Keep the heads of the screws out approximately 10mm.
5. Now hang the heater on screws and slide the heater across to the right and then down, locking the heater to the screws in the wall.

Operating Your Heater

WARNING: In order to avoid overheating or fire, do not cover the heater.

WARNING: Keep all objects at least 1 metre from the front and sides of the appliance.

WARNING: Do not use this heater with a programmer, separate timer, remote-control system or any other device that switches the heater on automatically, since a fire risk exists if the heater is covered or positioned incorrectly.

WARNING: Never leave this heater unattended when in use.

Ensure heater is on a flat, stable, heat-resistant surface.

Once the heater is in a safe operating position and all switches are in the off position, insert the power plug into the mains outlet and switch on.





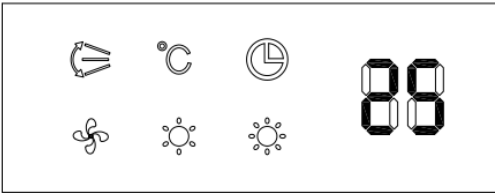

CAUTION: Ensure the power cord is not tight because if pulled it may partially pull the plug from the socket. A partially inserted plug will overheat the plug and socket and could result in fire.

Note: When the appliance is turned on for the first time, it may release a slight odour or smoke. This odour or smoke is a normal occurrence caused by the initial heating of the internal heating elements and should not occur again.

Operating Your Heater

DISPLAY PANEL





-  Swing (Auto louvre)
-  Temperature Mode
-  Timer Mode
-  Fan Mode
-  Low Heat Mode (1200W)
-  High Heat Mode (2400W)
-  Temperature/Timer Indicator

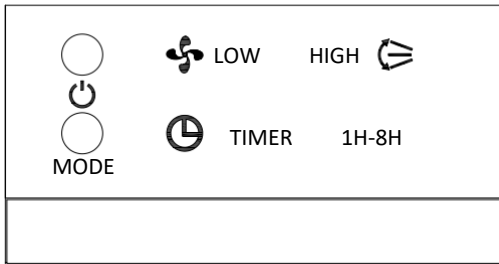





CONTROL PANEL



Fan mode:

- Press  button, the fan heater will switch ON and the fan will blow. Fan indicator is light.
- To switch the fan OFF, press  button. The fan heater will continue to operate for 10 -15 sec, and then it will switch OFF.

Heating mode:

- Press the  button successively to choose below function:
 - > Switch on  -> FAN -> Low Heating  -> High Heating 
 - > SWING  -> Switch Off.
 - The LED indicator will automatically light up and down while you pressing the  button by remote control or control panel buttons.
- To switch the heater OFF anytime, press  button until the fan indicator flashes. The fan heater will continue to operate for approx. 30 sec, and then it will switch OFF.
- MODE
- Press this button to set the TIMER from 1-8 hours in 0.5 hour increments.

Operating Your Heater

REMOTE

The remote control buttons are as follows:



Press once to turn the heater on to fan only.
Press again to put the heater back in standby.



The MODE button switches the heater between low and high heating.



Press the + or – buttons to set the desired temperature for your room.

The setting range is 10-49 °C. When you are setting the temperature, the display will show the setting temperature. After you have selected the desired temperature, the display will show the current temperature of your room. Press CANCEL  to cancel any programmed temperature.



Press the TIMER Button once and the heater will display 0.5 hours.

By pressing the TIMER Button again you can adjust the desired length of time in 0.5 hour increments to maximum of 8 hours.

The Timer indicator will illuminate on the control panel displaying your selected time.

For example: If the Timer is programmed to operate for 5 hours, the 4 hour and 1 hour light will be illuminated (as shown below).

To stop the Timer function, press TIMER button until all time indicators are OFF

Swing function can be individually operated by remote control, just press  button.

For best results, aim the remote directly at the remote sensor on the front panel of the heater.

The remote has a 3 metre range of operation.

The remote control requires 1 x CR2025 battery (Not included).

WARNING!



DANGER IF SWALLOWED

Keep batteries out of reach of children. Swallowing may lead to serious injury or death in as little as 2 hours due to internal burns.
If swallowed, go straight to a hospital emergency room.
Dispose of used batteries immediately.

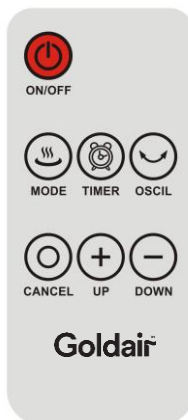

Operating Your Heater

SAFETY DEVICES

This appliance has two protection devices:

- Resettable Thermal Link - this will automatically disconnect the power to the appliance at a pre-set overheat temperature. After cooling down it will reset and power on again. If this occurs, investigate what is causing the appliance to overheat.
- Thermal Fuse - this disconnects the appliance permanently in case of overheating. (It is non resettable).

CAUTION: The appliance generates heat during use. Precautions must be taken to prevent the risk of burns, scalds, fires or other damage to persons.

CARE AND CLEANING

The heater requires regular cleaning to ensure trouble free operation:

- Unplug the heater from the mains supply before cleaning.
- Ensure that the heater has been allowed to cool down completely before cleaning.
- The common cause of overheating is deposits of dust or fluff in the appliance. Ensure these deposits are removed regularly by unplugging the appliance and vacuum cleaning the air vents and grills.
- Use a damp cloth (not wet) to wipe the exterior of the heater to remove dust and dirt.
- Never use solutions such as petrol, thinners or polishing agents.
- Ensure the heater is dry before plugging back into the mains supply.
- Do not attempt to dismantle the heater.
- There are no user serviceable parts. For service or repair, contact an authorised electrical service technician.

Goldair  
Model No: GCW240
Supply: 230-240VAC 50Hz
Wattage: 2400W
Approval: SAA-212528-EA
QC Passed: PO#-WWYY
MADE IN CHINA
CUSTOMER SUPPORT
NEW ZEALAND PH: 0800 232 633
AUSTRALIA PH: 1300 465 324

PROOF OF PURCHASE

To receive warranty retain receipt as proof of purchase.

Goldair™

SUPPORT AND TECHNICAL ADVICE

Goldair – New Zealand
Monday – Friday 8am-5pm
Phone +64 (0)9 917 4000
Phone 0800 232 633
info@cdb.co.nz

Goldair – Australia
Monday – Friday 8am-5pm
Phone +61 (0)3 9365 5100
Phone 1300 465 324
info@cdbgoldair.com.au



Two Year Warranty

Thank you for purchasing this Goldair product. Your product is warranted against faults and manufacture when used in normal domestic use for a period of **two years**. In non-domestic use Goldair limits the voluntary warranty to **three months**.

Goldair undertake to repair or replace this product at no charge if found to be defective due to a manufacturing fault during the warranty period.

This warranty excludes damage caused by misuse, neglect, shipping accident, incorrect installation, or work carried out by anyone other than a qualified electrical service technician.

PLEASE KEEP YOUR RECEIPT AS THIS WILL HELP VERIFY YOUR WARRANTY.

The benefits given to you by this warranty are in addition to other rights and remedies available to you under law in relation to the goods or services to which this warranty relates.

In Australia, our goods come with guarantees that cannot be excluded under the Australian Consumer Law. You are entitled to a replacement or refund for a major failure and compensation for any other reasonably foreseeable loss or damage. You are also entitled to have the goods repaired or replaced if the goods fail to be of acceptable quality and the failure does not amount to a major failure.

In New Zealand this warranty is additional to the conditions and guarantees of the Consumers Guarantee Act (1993).

Goldair – New Zealand

CDB Goldair
PO Box 100-707
N.S.M.C
Auckland

Phone +64 (0)9 917 4000
Phone 0800 232 633
www.goldair.co.nz

Goldair – Australia

CDB Goldair Australia Pty
PO Box 574
South Morang
Victoria, 3752

Phone +61 (0)3 9365 5100
Phone 1300 GOLDAIR (1300 465 324)
www.goldair.com.au

Goldair Two Year Warranty (IMPORTANT: Please complete and retain this warranty card)

Name _____

Address _____

Place Of Purchase _____ Date Of Purchase _____

Name Of Product _____ Model Number _____

Attach a copy of the purchase receipt to this warranty card



Goldair™



CDB  Goldair™

New Zealand
PO Box 100707,
North Shore Mail Centre,
Auckland, 0745
www.goldair.co.nz

Australia
PO Box 574,
South Morang,
Victoria, 3752
www.goldair.com.au