



# User Guide



# NanoBark™ 2.0

## Bark Collar for Small Dogs

### Before we start:

We know that teaching your dog when not to bark can be challenging. Keep these things in mind as you begin training:

#### **We care about your dog's safety.**

This bark collar has a unique sensor that provides the most reliable bark detection available. The 10 correction levels are designed specifically for small- to medium-sized dogs and are very gentle, even when levels need to increase. As a safety feature, if your dog barks 15 times or more within an 80-second period, the bark collar will automatically time out for 30 seconds.

#### **Not all barking is bad.**

Your dog barks for a variety of reasons, many of which may be desirable, such as warding off threats or alerting you to unexpected visitors. Reserve the use of the bark collar for situations in which your dog's bark is excessive or obtrusive — for example, maybe your dog loves to bark outside late at night or greets your guests a little too loudly. Appropriate and consistent use of the bark collar can substantially reduce and even eliminate this nuisance barking.

## Take care to get the right fit.

Proper fit is essential to the effectiveness and safety of the bark collar. A bark collar worn too loosely won't accurately detect and correct your dog's barks, but a bark collar worn too tightly (or too long) may irritate your dog's skin. Avoid leaving the bark collar on your dog for more than 12 hours a day, and please read this guide and the customer care guide thoroughly for important safety information about how to fit and use the bark collar.

**Important:** Do not use the bark collar on dogs younger than 6 months old.

# Let's take your dog from yappy to happy.

## What you have:

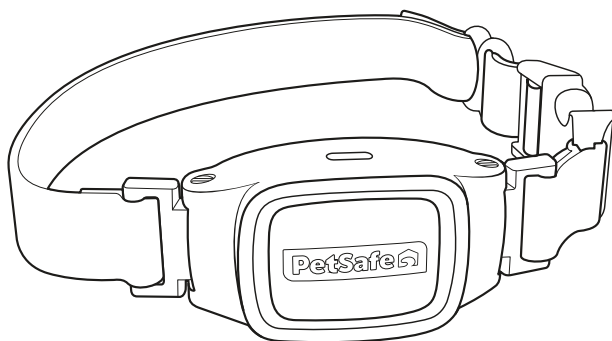

Bark collar with short contact points

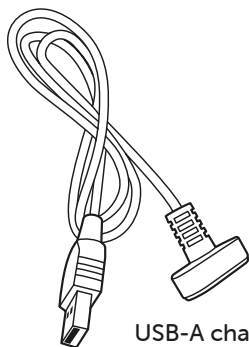

USB-A charging cable  
(USB-A adaptor not included)



Long contact points



Test light  
tool



Anti-strip  
wrench

## How it works:

The bark collar starts learning your dog's bark pattern after the first two to three barks and automatically adjusts its correction for your dog's personality and barking habits.

There are 10 levels of static correction. The first time your dog barks, they will receive the lowest level of static correction. If they continue barking, the correction intensity will increase with each successive bark until the barking stops. This correction level becomes the starting point the next time your dog barks. Once your dog has learned to reduce their barking, the initial warning corrections are automatically decreased.

# 1 Charge the bark collar

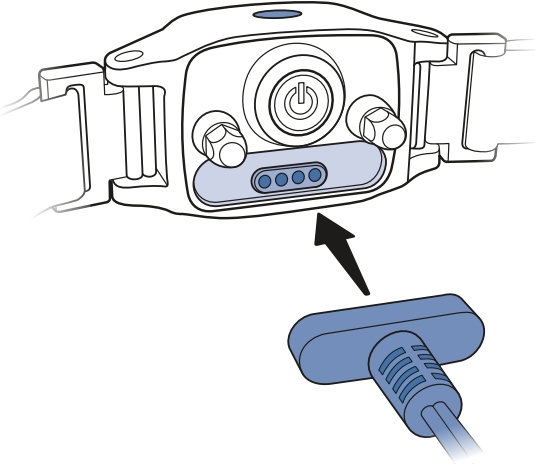

Connect the USB-A charging cable to the magnetic charging port on the back of the collar and then plug it in to a USB-A outlet or adaptor. Leave the bark collar plugged in until it is fully charged; this will take about 2 hours.

The LED on the top of the bark collar will glow green when the collar is charging and will turn off when the bark collar is fully charged.

Average battery life is up to 7 days, depending on how often your dog barks.

## 2 Select contact points

To loosen:

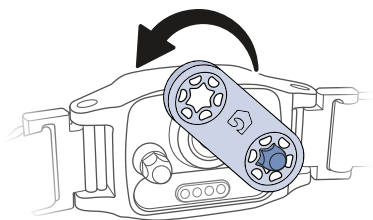

To tighten:

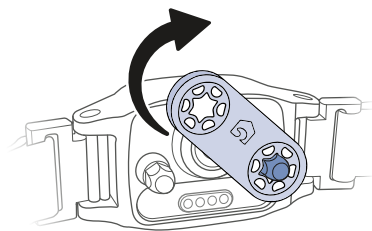

The bark collar comes with short contact points preinstalled. If your dog has long or thick hair, it may be necessary to switch to the long contact points provided or trim (not shave) the hair around the contact points to make sure that contact is consistent.

**Important:** Use the provided anti-strip wrench to loosen and tighten the contact points. Do not use any other tool to tighten the contact points; this can lead to overtightening and may damage the collar.

### 3 Fit the bark collar

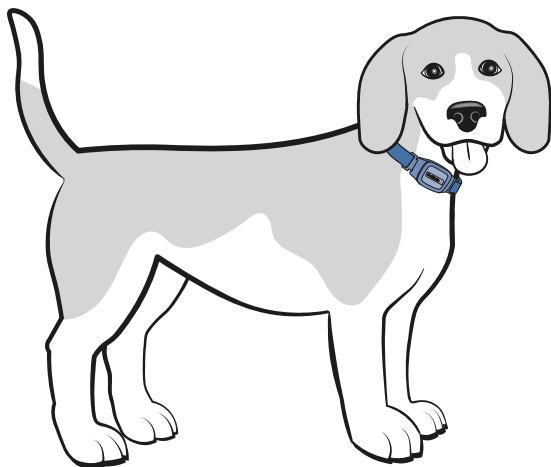

With your dog standing comfortably, place the bark collar high around their neck, close to the ears. The contact points should be centered directly under your dog's chin, touching the skin.

Check the tightness of the bark collar by inserting one finger between the collar and your dog's neck. The fit should be snug but not constricting. If your dog shakes their head (after fitting), the collar should not move.

Remember to recheck the fit of the bark collar frequently as your dog becomes comfortable wearing it.

**Important:** Metal hardware or tags on other collars can interfere with the bark collar and cause false corrections. If your dog wears a second collar, it must be non-metallic.

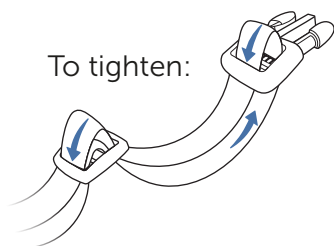
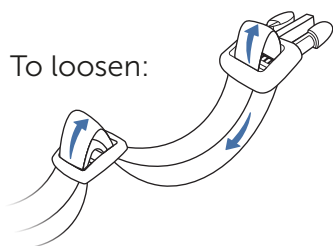

## 4 Turn the bark collar on

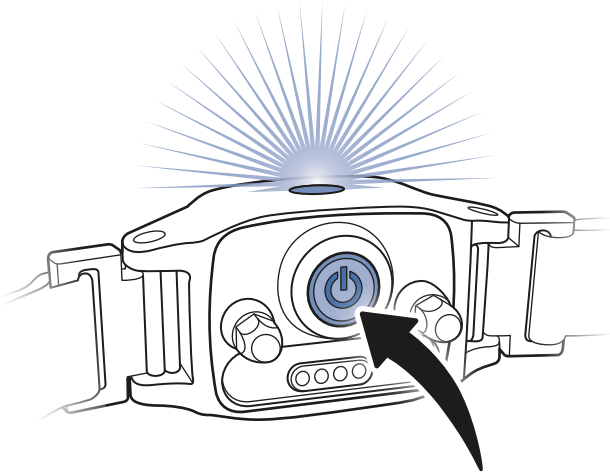

Turn the bark collar on by pressing and holding the power button until the bark collar beeps low to high and the LED on the top of the collar flashes green. The LED will flash every 5 seconds (green or red) to indicate battery charge.

## 5 Use the bark collar

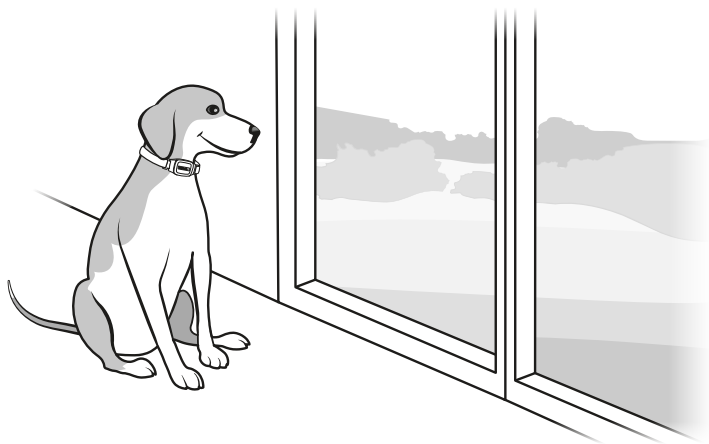

Stay with your dog the first few times they wear the bark collar. They may initially be startled by the correction and bark more. If this happens, speak to your dog in a calm, reassuring voice until they relax. They'll soon realize that the correction stops when they are quiet.

You should notice a reduction in your dog's barking within the first couple of days of wearing the bark collar. At this point, it is important to remember the learning process is still not complete. Dogs will test this new learning experience and may increase their attempts to bark. This usually occurs during the second week a dog wears the bark collar. If this does occur, remain consistent and do not alter your use of the bark collar.

If your dog barks and the bark collar doesn't seem to be correcting them:

**Recheck  
the fit.**

The bark sensor uses vibration to detect your dog's bark. This is what prevents the bark collar from correcting your dog for other dogs' barking or loud noises nearby.

If the bark collar is too loose, the bark sensor will not be able to detect the vibration of your dog's vocal cords and the bark collar will not issue a correction. Likewise, if the contact points are not in contact with your dog's skin, they will not feel a correction if issued.

## Test the bark collar.

If you are certain you have fit the bark collar properly to your dog but it still doesn't seem to be working, complete the following steps to test the bark collar. You will need the [test light tool](#).

1. With the bark collar charging, press and hold the power button.
2. Continue to hold the power button while disconnecting the bark collar from the USB-A charging cable.

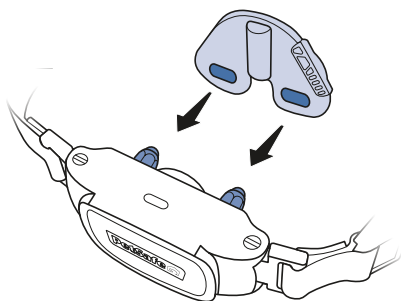

3. When the LED turns blue, release the power button and then hold the test light tool to the collar's contact points.

After a 2-second delay, the bark collar will be in test mode. For each level, the collar will beep and then the test light tool will flash (level 1 = 1 beep, level 2 = 2 beeps, etc.).

4. When the test is complete, the bark collar will beep high to low and turn itself off. You can stop the test at any time by pressing the power button.

Remember these important tips when using your bark collar:

**Be consistent.** Use the bark collar in every situation in which you want your dog to be quiet. If your dog realizes they are not wearing their bark collar, they may resume unwanted barking habits, which can delay their learning.

**Attach your leash separately.** When using a leash, attach it to a separate, non-metallic collar or harness. **Important:** Please don't attach a leash to the bark collar, as this puts too much pressure on the contact points.

**Maximize battery life.** Turn off the bark collar when not in use by pressing and holding the power button until the bark collar beeps high to low and the LED flashes red and then turns off.

**Turn down the noise.  
Turn up the joy.**

# NanoBark™ 2.0

## Bark Collar for Small Dogs



**We're here to help!**

For questions or additional tips:  
[support.petsafe.com](https://support.petsafe.com)

1-Year Limited Warranty | ©2026 Radio Systems Corporation  
Model: PBC00-18240 | 400-2752/1  
For important safety instructions, please see the customer care guide.