

<b>PRECAUTIONS</b>	<b>28</b>	Preliminary operations	36
General safety instructions	28	Using the hob	38
Installation	31	Additional functions	41
Appliance purpose	32	Special functions	42
This user manual	32	User menu	44
Manufacturer's liability	33	Error notifications	46
Identification plate	33	<b>CLEANING AND MAINTENANCE</b>	<b>46</b>
Disposal	33	Cleaning the glass ceramic hob	46
To save energy	33	What to do if...	46
Information on power consumption in off/stand-by mode	33	<b>INSTALLATION</b>	<b>47</b>
How to read the user manual	33	Electrical connection	47
<b>DESCRIPTION</b>	<b>34</b>	Section cut from the countertop	48
General description	34	Mounting	49
Control panel	35	Ventilation	50
<b>USE</b>	<b>36</b>	Fixing to the built-in cabinet	50
Basic functions	36	Instructions for the installer	50

We advise you to read this manual carefully, which contains all the instructions for maintaining the appliance's aesthetic and functional qualities. For further information on the product: [www.smeg.com](http://www.smeg.com)

## PRECAUTIONS

### General safety instructions

#### Risk of personal injury

- During use the appliance and its accessible parts become very hot. Keep children well away from the appliance.
- Protect hands with heat resistant gloves during use.
- Never try to put out a fire or flames with water: Turn off the appliance and smother the flames with a fire blanket or other appropriate cover.
- This appliance may only be used by children aged 8 years and over, and by people of reduced physical, sensory or mental capacity, or lacking in experience in the use of electrical appliances, provided that they are supervised or have been given instructions on the safe use of the appliance and of the hazards associated with it.
- Children must not play with the appliance.
- Keep children under the age of eight at a safe distance unless they are constantly supervised.
- Keep children under the age of 8 away from the appliance when it is in use.
- Cleaning and maintenance must not be carried out by unsupervised children.
- Be aware of how rapidly the cooking zones heat up. Do not place empty pans on the heat. Danger of

- overheating.
- Activate the controls lock when you have children or pets which could reach the hob.
  - Do not touch or clean the hob surface during operation or when the residual heat indicator lights are still on.
  - After use, switch off the plates. Never rely solely on the cookware detector.
  - Supervise children carefully as they cannot readily see the residual heat indication. After use the cooking zones remain hot for a certain period of time even if they have been turned off. Keep children away from the cooking zones.
  - The cooking process must always be kept under control. A short cooking process must be continuously monitored.
  - **WARNING:** Cooking foods containing fat and/or oil without monitoring them can be dangerous and can cause a fire.
  - Fats and oils can catch fire if they overheat. Do not leave the appliance unattended while preparing foods containing oils or fats. If fats or oils catch fire, never put water on them. Place the lid on the pan and turn off the relevant cooking zone.
  - Do not use the Booster and/or the Double Booster functions (if present) to heat fats or oils. Fire hazard.
  - Do not place metal objects, such as dishes or cutlery, on the surface of the hob during cooking as they may overheat.
  - Do not cook foods in closed tins or containers or plastic containers.
  - Do not use magnetic tins.
  - Do not use trivets or other items between the bottom of the pan and the glass ceramic surface. Danger of burns.
  - Do not insert pointed metal objects (cutlery or utensils) into the slots in the appliance.
  - Do not use or store flammable materials near the appliance or directly underneath the hob.
  - Switch off the appliance immediately after use.
  - Do not pull the cable to unplug the appliance (if present).
  - **DO NOT USE AEROSOLS IN THE VICINITY OF THIS APPLIANCE WHILST IT IS IN USE.**
  - **DO NOT MODIFY THIS APPLIANCE.**
  - Always wear personal protective equipment (PPE) before carrying out any work on the appliance (installation, maintenance,

positioning or moving).

- Do not clean the appliance if it is still hot or in operation.
- After use the cooking zones remain hot for a certain period of time after they have been turned off. Do not touch the hob surfaces.
- Before performing any work on the appliance, switch off the power supply.
- Do not try to repair the appliance yourself or without the assistance of a qualified technician.
- If the power cable becomes damaged, contact technical support immediately to arrange for it to be replaced in order to avoid possible hazards.
- If cracks or fissures form, or if the glass ceramic cooking surface breaks, turn off the appliance immediately. Disconnect the power supply and call Technical Support.
- People who have pacemakers or other similar devices fitted must make sure that the operation of these devices is not affected by the induction field, the frequency range of which is between 20 and 50 kHz.

### **Risk of damaging the appliance**

- Do not use abrasive or corrosive detergents (e.g.

scouring powders, stain removers and metallic sponges) on glass parts.

- Use wooden or plastic utensils.
- Do not sit on the appliance.
- Do not use the glass ceramic cooking surface as a support surface.
- Do not use the appliance as a support surface.
- Do not obstruct ventilation openings and heat dispersal slots.
- Do not use the hob if the pyrolytic cycle is taking place inside any oven installed below.
- Do not use steam jets to clean the appliance.
- Never leave the appliance unattended during cooking operations where fats or oils could be released, as these could then heat up and catch fire. Be very careful.
- Fire hazard: Never leave objects on the cooking surfaces.
- DO NOT FOR ANY REASON USE THE APPLIANCE AS A SPACE HEATER.
- Cooking vessels or griddle plates should be placed inside the perimeter of the hob.
- All pans must have smooth, flat bottoms.
- If any liquid does boil over or spill, remove the excess

from the hob.

- Take care not to spill acid substances such as lemon juice or vinegar on the hob.
- Do not spill sugar or sweet mixtures on the hob during cooking.
- Do not place materials or substances that could melt or catch fire (paper, plastic or aluminium foil) on the appliance while it is in use.
- Place the cookware directly on the glass ceramic surface.
- Do not put empty pans or frying pans on switched on cooking zones.
- Do not use rough or abrasive materials or sharp metal scrapers.
- The glass ceramic surface is highly resistant to impact. However, prevent hard, solid objects from falling on the cooking surface as they may cause it to break.
- Do not use cleaning products containing chlorine, ammonia or bleach on parts made of steel or that have metallic surface finishes (e.g. anodizing, nickel- or chromium-plating).
- This appliance is not intended to be operated by means of external timer or separate remote control system.
- To prevent scratching the glass surface, avoid sliding

pots across it. Lift them and place them gently where needed instead.

## Installation

- **THIS APPLIANCE MUST NOT BE INSTALLED IN A BOAT OR CARAVAN.**
- This appliance must not be installed above a dishwasher unless the instructions provided in the "INSTALLATION" chapter are complied with.
- Position the appliance into the cabinet cut-out with the help of a second person.
- Check that the cabinet has the required slots.
- Check that the cabinet material is heat resistant.
- Installation and servicing should be carried out by qualified personnel in accordance with current standards.
- Have the electrical connection performed by authorised technical personnel.
- The appliance must be connected to earth in compliance with electrical system safety standards.
- Use cables that can withstand temperatures of at least 90°C.
- Run the power cable in the rear part of the unit. Make sure that it does not come into contact with the lower part of the hob or a built-in oven below it.

- Be careful when connecting additional electrical appliances. Connection cables must not come into contact with hot cooking zones.
- The tightening torque of the screws of the terminal supply wires must be 1.2-1.5 Nm.
- Do not attach the appliance too tightly to the unit as this could cause damage during use or partially obstruct the heat dispersal slots.
- The power cable must only be installed or replaced by a qualified technician.
- If the power cable becomes damaged, contact technical support immediately to arrange for it to be replaced in order to avoid possible hazards.
- Always use any necessary/required personal protective equipment (PPE) before performing any work on the appliance (installation, maintenance, positioning or movement).
- Before performing any work on the appliance, switch off the main power supply.
- Allow the appliance to be disconnected after installation, via an accessible plug or a switch in the case of a fixed connection.
- Fit the power line with an all-pole circuit breaker with

a contact separation distance sufficient to provide complete disconnection in category III overvoltage conditions, pursuant to installation regulations.

- If access to the electrical power supply is limited, means of disconnection of all poles must be accessible and incorporated into the fixed wiring in accordance with the wiring regulations.
- This appliance can be used up to a maximum altitude of 2,000 metres above sea level.

### Appliance purpose

This appliance is intended for cooking food in the home environment. Every other use is considered improper. It must also not be used:

- In kitchen areas provided for employees in shops, offices and other work environments.
- in farms/farmhouses.
- By guests in hotels, motels and other types of residential environments.
- In bed and breakfasts.



This appliance may only be installed and used indoors.

### This user manual

- This user manual is an integral part of the appliance and must therefore be kept in its entirety and within the user's reach for the whole working life of the appliance.

- Read this user manual carefully before using the appliance.
- The explanations in this manual include images, which describe all that regularly appears on the display. However, it should be kept in mind that the appliance may be equipped with an updated version of the system, and as such, all that appears on the display may differ from those in the manual.

## Manufacturer's liability

The manufacturer declines all liability for damage to persons or property caused by:

- use of the appliance other than that specified;
- failure to comply with the instructions in the user manual;
- tampering with any part of the appliance;
- use of non-original spare parts.

## Identification plate

The identification plate bears the technical data, serial number and brand name of the appliance. Do not remove the identification plate for any reason.

## Disposal



This appliance conforms to the WEEE European directive (2012/19/EU) and must be disposed of separately from other waste at the end of its service life.

The appliance does not contain substances in quantities sufficient to be considered hazardous to health and the environment, in accordance with current European directives.



### Power voltage Danger of electrocution

- Disconnect the mains power supply.
- Unplug the appliance.

To dispose of the appliance:

- Cut the power cable and remove it.
- Deliver the appliance to the appropriate recycling centre for electrical and electronic equipment waste, or return it to the retailer when purchasing an equivalent product, on a one for one basis.

Our appliances are packaged in non-polluting and recyclable materials.

- Deliver the packing materials to the

appropriate recycling centre.



### Plastic packaging Danger of suffocation

- Do not leave the packaging or any part of it unattended.
- Do not let children play with the plastic bags.

## To save energy

- The diameter of the base of the pan must not extend beyond the lines printed on the glass ceramic surface.
- Pans must not be placed outside the perimeter of the hob or on the display.
- When buying a pan, check whether the diameter indicated is that of the base or the top of the pan, as the top is almost always larger than the base.
- When preparing dishes with long cooking times, you can save time and energy by using a pressure cooker, which also helps to retain vitamins contained in the food.
- Make sure that the pressure cooker contains enough liquid as, if there is not enough and it overheats, this may cause damage to both the pressure cooker and the cooking zone.
- If possible, always cover pans with a suitable lid.
- Choose a pan suitable for the quantity of food to be cooked. A large, half-empty saucepan leads to a waste of energy.



Under certain circumstances, if the hob and the oven are used at the same time, the maximum power limit of the electrical system might be exceeded.

## Information on power consumption in off/stand-by mode

Technical data on the appliance's power consumption in off/stand-by mode can be found at [www.smeg.com](http://www.smeg.com) under the page corresponding to the product in question.

## How to read the user manual

This user manual uses the following reading conventions:



Warning/Caution



# DESCRIPTION

## General description

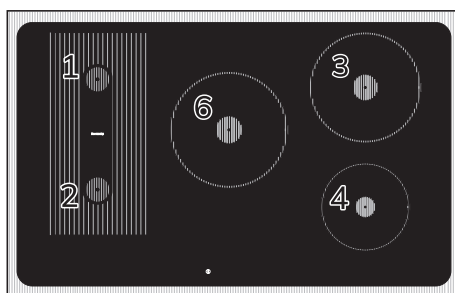
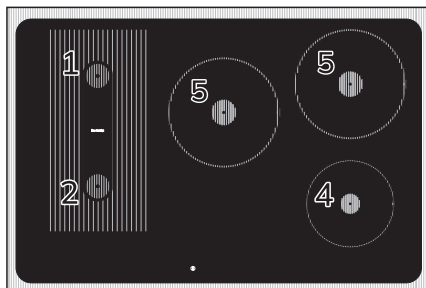
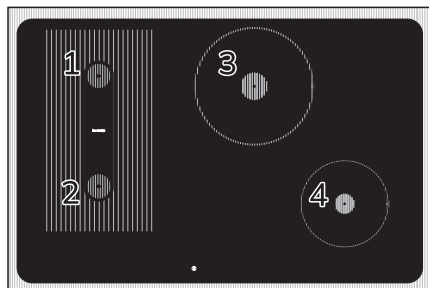

Zone	Dimensions H x L (mm)	Power draw at lev. 9 (W)*	Power draw in Booster function (W) *	Power draw in Double Booster function (W)*
1 - 2 (single)	180 x 210	2100	2500	3000
1 - 2 (multizone)	360 x 210	3000	3700	-
3	210 x 210	2300	3000	-
4	160 x 160	1400	2100	-
5	200 x 200	2300	3000	-
6	250 x 250	2300	3000	-

\*Power levels are approximate and may vary according to the pan used or the settings made.

## Control panel

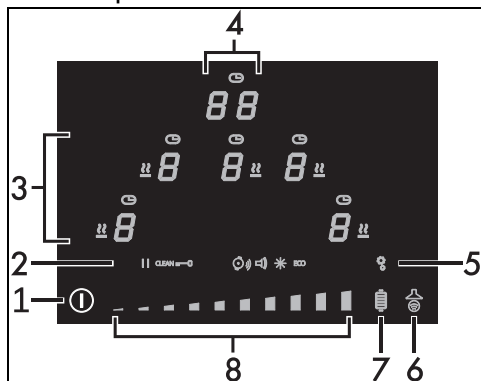

1. ON/OFF button
2. Settings icons
3. Cooking zones display
4. Timer display
5. Settings menu button
6. Auto-Vent 2.0 function button
7. Grill function button
8. Scroll bar

### List of icons

- Warming Function.
- Timer
- Pause Function
- Clean Function
- Controls Lock Function.
- Automatic pan detection function.
- Button volume.
- Display brightness.
- ECO function.

### List of buttons

- On/Off: turns the hob on or off.
- Settings menu: allows you to access the appliance's settings.
- Grill Function: activates the Grill function.
- Auto-Vent 2.0 function: activates communication between the hob and the extractor hood.

Scroll bar: increases or decreases the power level of a cooking zone, allows you to adjust settings and to select user menu options.

### Cooking zones display



The buttons for selecting the cooking zones and the timer icons above each of them and the Warming function icon are found in this zone.

### Timer display



The controls for setting the independent timer and the timer for the cooking zones are located in this area. The following text is displayed when it is possible to set an

independent timer

### Advantages of induction cooking



The appliance is equipped with an induction generator for each cooking zone. Each generator located under the glass ceramic cooking surface creates an electromagnetic field which induces a thermal current in the base of the pan. This means the heat is no longer transmitted from the hob to the pan but created directly inside the pan by the inductive current.

- Energy saving thanks to the direct transmission of energy to the pan (suitable magnetisable cookware is required) compared to traditional electric cooking.
- Improved safety as the energy is only transmitted to the pan placed on the hob.
- High level of energy transmitted from the induction cooking zone to the base of the pan.
- Rapid heating speed.
- Reduced danger of burns as the cooking surface is only heated under the base of the pan; foods which overflow do not stick.

### Power control

The hob is fitted with a power control module that optimises/limits consumption. If

the overall set power level exceeds the maximum limit permitted, the electronic circuit board will automatically manage the power supplied by the hot plates. The module tries to maintain the maximum deliverable power levels. Levels set by the automatic control will appear on the display.



Priority is given to the last zone set.



The power control module does not affect the total power consumption of the appliance.



## USE

### Basic functions

#### First power connection



When connected to the power supply for the first time, or after power has been switched back on after a power failure, an automatic check is carried out that control turns on the indicator lights and the displays for a few seconds. Afterwards, the appliance can be used normally.

#### Switching on the hob for the first time

When the appliance is used for the first time, after having been connected to the

mains power supply, the flashing  symbol appears on the display. It is used to access the appliance's technical menu and is intended only for Technical Support personnel.

When the appliance is switched on, the  icon, the

dimly lit  button and the text  appear on the timer display.

### Preliminary operations



See General safety instructions.

- Remove any protective film from the outside or inside of the appliance, including any accessories (if present).
- Remove any labels (apart from the technical data plate).

### Usable pan diameters

Burner	minimum $\emptyset$ (cm)	$\emptyset$ recommended (cm)
Zone 1 - 2 (single)	11*	18
Zone 1 - 2 (Multizone)	19	22
Zone 3	11*	25
Zone 4	9*	21
Zone 5	11*	21
Zone 6	13*	21

\*If you use pans with a diameter less than the one indicated in the column above, the appliance might not detect them.

Bear in mind the following:

- Do not exceed the limits of the zones printed on the hob.
- Do not cover the control panel.
- Do not place the pans next to the edges of the glass.
- If you wish to use a griddle or a long pan in zones 1 and 2 in Multizone mode, it is recommended that you use one with a maximum size of 22 x 36 cm.

### Cookware suitable for use in induction cooking

Cookware used on the induction cooking surface must be made of metal, with magnetic properties and a sufficiently large base.

#### Suitable cookware:

- Enamelled steel cookware with thick bases.
- Cast iron cookware with an enamelled

base.

- Cookware in multilayer stainless steel, ferritic stainless steel and aluminium with a special base.

#### Unsuitable cookware:

- Copper, stainless steel, aluminium, fireproof glass, wood, ceramic and terracotta cookware.

#### Advice on energy-saving

The diameter of the base of the pan must correspond to the diameter of the cooking zone.



- When buying a pot, check whether the diameter indicated is that of the base or the top,

as the top is almost always larger than the base.

- The base of the cookware must be thick and completely flat. In addition, the hob should be clean and dry as well.
- When preparing dishes with long cooking times, you can save time and energy by using a pressure cooker, which also makes it possible to preserve the vitamins in the food.
- Make sure that the pressure cooker contains enough liquid as, if there is not enough and it overheats, this may cause damage to both the pressure cooker and the cooking zone.
- If possible, always cover the pans with a suitable lid.
- Choose a pan suitable for the quantity of food to be cooked. A large, half-empty saucepan leads to a waste of energy.
- Do not use cast-iron cookware or cookware with a rough base.



If hob and oven are being used at the same time, under certain conditions the maximum power limit that can be used by your electrical system might be exceeded.

#### Advice on energy-saving

To see whether the pan is suitable, bring a magnet close to the bottom: if it is attracted, the pan is suitable for induction cooking. If you do not have a magnet, you can put a small amount of water in the pan, place it

on a cooking zone and start the hot plate. If the  symbol appears on the display, it means the pan is not suitable.

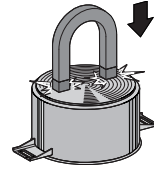

#### Pan detection indication

Once a zone has been activated / selected, if the  symbol appears on the display, it means the pan is unsuitable.

The  symbol is also displayed if there is no pan present or if it is removed.



Use only cookware with a perfectly flat bottom which is suitable for induction hot plates. Using pans with an irregular bottom could jeopardise the efficiency of the heating system and prevent the pan from being detected on the hot plate.



Make sure that the pans do not cover the control panel.

#### Power level table

The power in the cooking zones can be adjusted to various levels. In the table below you will find instructions for the different types of cooking.

Power level	Suitable for:
0	OFF setting
from 1 to 2	Cooking small amounts of food (minimum power)
from 3 to 4	Cooking
from 5 to 6	Cooking large quantities of food, roasting larger portions
from 7 to 8	Roasting, slow frying with flour
9	Roasting
P 	Roasting / browning (maximum power, see Booster and Double Booster)

#### Limiting the cooking duration

The appliance has an automatic device that limits the duration of use.

If the cooking settings for a pan are not changed, the maximum operation time for

each zone depends on the power level selected.

Heating is switched off when the device for limiting the duration of use is activated.

Power level	Maximum cooking duration in hours
1	8 ½
2	6 ½
3	5 ½
4	4 ½
5	3 ½
6	1 ½
7	1 ½
8	1 ½
9	1 ½

## Using the hob

### Switching on and off



To switch on the hob, press and hold the ON/OFF  button for 1 second.

If no cooking zone is activated within 5 seconds of switching on, the hob switches off automatically.

- The text  appears on the timer display for a few seconds, during which an independent timer can be set (see "Independent timer").
- If power limitation has been set, the number associated with the set power will be displayed for a few seconds

instead of . In this case, it is still possible to set an independent timer by touching the timer display.

### Switching on the cooking zone automatically

 The hob is fitted with an automatic pan detection system, indicated by the  icon. This feature is active by default, but can be deactivated via the user menu.

After switching on the hob:

- Position a pan (suitable for induction cooking and not empty) on the cooking zone you wish to use.
- The button corresponding to the zone on which the pan has been placed

switches on automatically and  is displayed. The other zones cannot be activated.

If the automatic pan detection system is not active, when the appliance is switched on the  symbol will appear on the displays of all the cooking zones. To activate the zones, select them using the relative display and choose the required power level.

### Adjusting cooking zones

 The appliance is fitted with an automatic pan sensing system.

After switching on the display:

1. Position a pan (suitable for induction cooking and not empty) on the cooking zone you wish to use.
2. The display corresponding to the zone on which the container has been placed turns on automatically and displays .

### Adjusting cooking zones

After having placed a pan on the cooking zone and made sure that the zone has been activated:

1. Place a finger on the left-hand side of the scroll bar of the cooking zone to be used.



The power level is now .

2. Move your finger to the left or right to select the power level from 1 to 9 or enable the Booster or Double Booster function (see specific sections).

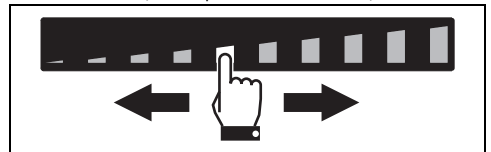

The display of the zone being used will indicate the selected power level.

 The power level can also be selected by pressing the scroll bar at the point that corresponds to the required power level.

## Switching off the cooking zones

1. Move your finger to the far left of the scroll bar of the cooking zone you wish to turn off.

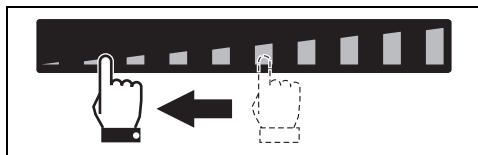

1. The display of the zone selected indicates .



To switch off more than one cooking zone at the same time, simply switch off the appliance using the button.

## Quick selection



The appliance is fitted with an automatic pan sensing system.

After switching on the appliance and having selected a cooking zone:

1. Place a finger on the scroll bar at approximately the required power level.

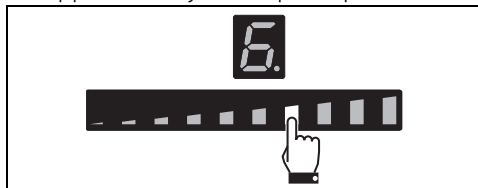

2. Move your finger to the left or right to select the required cooking power.

## Booster function

After switching on the hob and having selected a cooking zone:

1. Place a finger on the left-hand side of the scroll bar.

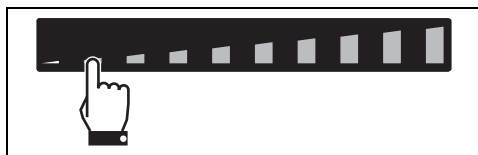

The display of the cooking zone used will turn on: the power level indicated is "1".

2. Slide your finger to the far right on the scroll bar to select power level 9.

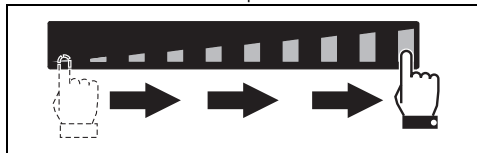

3. Press the segment at the far right of the scroll bar.

The display of the cooking zone used will show "P". Select any other power level to deactivate the Booster function.

The Booster function can be activated quickly.

- After switching on the hob and having selected a cooking zone, press the last segment at the far right of the scroll bar twice.

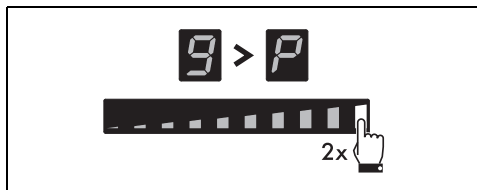

- The Booster function remains active for a maximum of 5 minutes, after which the power is reduced automatically to level 9.

## Double Booster Function



See General safety instructions.

The Double Booster function allows more power to be supplied compared to the Booster function.

After having activated the Booster function for a cooking zone, press the far right of the scroll bar again. The symbols and and

will be displayed in sequence to indicate that the Double Booster function is on.

To deactivate the function, simply select any other power level or switch off the appliance.



The Double Booster Function is only available for zones 1 and 2.

## Multizone function



This function allows you to operate two cooking zones (front and rear) at the same time when using pans such as fish kettles or rectangular containers. It can only be activated between zones 1 and 2.

After switching on the hob:

1. Place a finger on the front and rear left zone buttons at the same time.

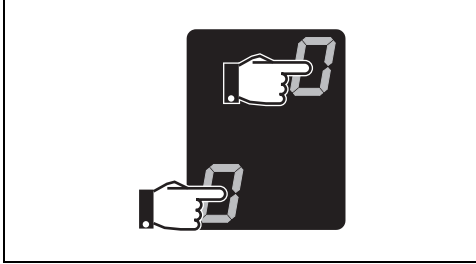

After a short beep, the **M** symbol will display next to the button of the rear zone. The Multizone function is now active.

2. Use the left-hand scroll bar to set the required cooking power.

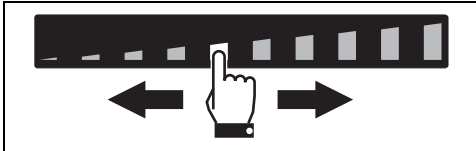

The same power level is set on both cooking zones.



It is not possible to activate the Double Booster function for the cooking zones on which the Multizone is active.



The Multizone function can also be activated automatically by placing an elongated pan across zones 1 and 2.

If a large, oval or oblong pan is being used, make sure that it is placed in the centre of

the cooking zone.

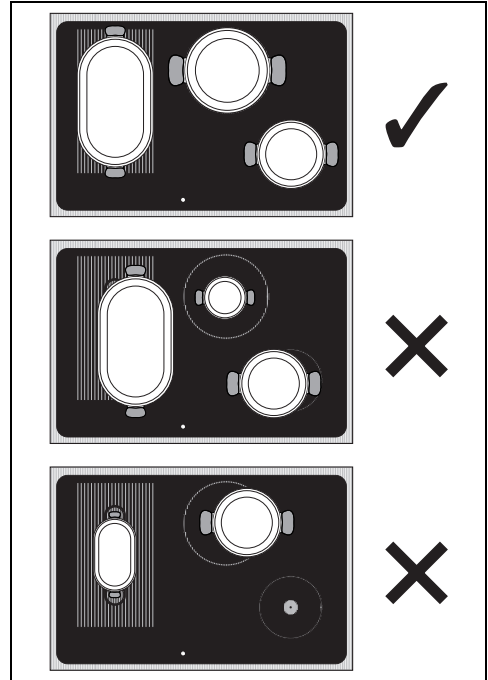

If using a griddle, make sure it is positioned correctly.

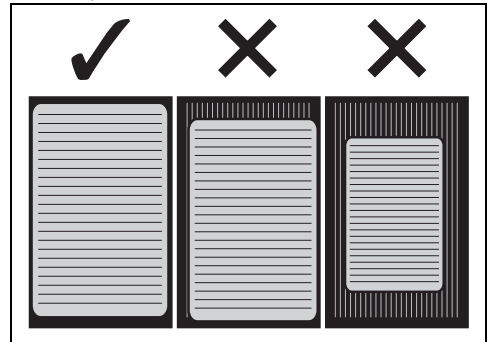

**To deactivate the Multizone function:**

Simultaneously press the buttons of the cooking zones on which the Multizone function is active. The **M** symbol disappears and the two zones can be regulated separately.

**Residual heat indicator**

After the cooking zone has been switched off, a symbol appears on each display to indicate whether the zone is still hot and indicates the approximate temperature:

1. if the temperature is between 60 °C and 79 °C.
2. if the temperature is between 80 °C and 99 °C.
3. if the temperature is 100 °C or higher.



Supervise children carefully as they cannot easily see the residual heat indicator. The cooking zones remain hot for a certain period of time even after they have been turned off. Make sure that children never touch the hob.

## Additional functions

### Rapid heating function



This function is not available for power level 9 or the Booster and Double Booster functions

The rapid heating function heats one cooking zone at maximum power for a limited time, after which it continues cooking at the set power level.

After selecting a cooking zone:

- Press and hold a power level (from 1 to 8) for at least 3 seconds.
- appears on the display of the cooking zone.
- After the heating time has elapsed, the cooking zone reverts to the previously selected power level.
- This function can be deactivated by pressing and holding the set power level for at least 3 seconds, or by selecting a lower power level.

### Rapid heating times

Power level	Automatic heating time (minutes/seconds)
1	48 s
2	2 m 24 s
3	3 m 50 s
4	5 m 12 s
5	6 m 48 s
6	2 m
7	2 m 48 s
8	3 m 36 s

### Warming function

To activate the Warming function, first turn on the hob, then:

1. Select a cooking zone.
2. Press the far left of the scroll bar, approximately between level 0 and level 1, to activate the function; the symbol appears on the display of the selected cooking zone.

Select any power level to deactivate the

Warming function. Or press the button.



This function allows you to keep cooked food warm or to keep water on the boil.



The warming function deactivates automatically after 2 hours of operation and switches off the cooking zone used.

### Independent timer

After having switched on the hob, without selecting a zone:

3. Touch the inside of the timer setting area, where "CL" is displayed.
4. appears and the icon flashes on the display.
5. Pressing again will cause the digit on the left to flash. It is now possible to set the minutes using the scroll bar (e.g. ).
6. When the digit on the left stops flashing, the tens of minutes (e.g. ) can be selected using the same procedure.
7. After a few seconds, the timer will start the countdown.



This function is used to set a countdown timer that will emit a sound at the end of the pre-set time.



A maximum time of 99 minutes can be set.

## Timed cooking



A maximum of 99 minutes can be set.



This function is used to program the automatic switch-off of each cooking zone at the end of a period of time.



This function can be activated on multiple cooking zones at the same time.

The timed cooking function can be activated when at least one cooking zone is switched on:

1. Select a power level.
  2. Follow the same procedure as for an independent timer.
- The  symbol is displayed above the cooking zone display to indicate that the zone is timed.
3. Timed cooking will start a few seconds after the last selection.
  4. When the time elapses, a series of beeps will be emitted. This can be deactivated by pressing the timer area.

## Modifying or deactivating timed cooking



If you modify a timer that has already been started, it has to be started again from the beginning.

1. Use the  button to activate the hob
2. To modify or deactivate the timer and timed cooking, simply press the timer setting area and follow the same procedure used for setting it in order to modify or zero the minutes.

## Recall Function



This is used to restore some functions that have already been started after the appliance has been switched off unintentionally.

If the appliance is switched off unintentionally, carry out the following procedure within 6 seconds:

1. Switch on the appliance.
- The  button starts to flash.

2. Press the pause button  immediately to restore the functions that were previously active.





This function restores the cooking zones, timer and rapid heating functions; no other functions will be restored.

## Special functions

### Grill Function

To activate the Grill function:

1. Place a griddle or a long pan on the left zones.
2. Press the  button, which starts to flash.

The  symbol appears on the front zone display and the  symbol appears on the rear zone display. The scroll bar will be set automatically to level 9. (preheating stage). After three minutes of operation, the power will be reduced to level 7.

The  button remains lit steadily.

Press the  button and use the scroll bar to modify the power level at any time.

Press the  button to deactivate the Grill function.



This function is used to automatically activate the Multizone function for the left zones only. It is used when cooking with a griddle or long pans.

### Auto-Vent 2.0 function



- This function allows the speed of the hood extractor fan to be controlled via a wireless connection.
- The hood must be designed to use the Auto-Vent 2.0 function.
- The connection is always unidirectional, from the hob to the hood: it is not possible to control the hob via the hood.

The Auto-Vent 2.0 function is deactivated by default, but can be enabled from the user menu. When enabled, the  button remains dimly lit at all times.

This function has an automatic and a manual mode:

- Automatic mode (default) adjusts the speed of the hood extractor fan

according to the total power of the appliance (see "User menu - option U8).

- Manual mode allows the speed of the hood extractor fan to be controlled by pressing the  button.



After switching on the hob, activate manual mode as follows:

1. Press the  button, which will light up at maximum brightness.
2. Each subsequent press of the button increases the speed of the extractor hood fan according to a cyclic sequence with 5 levels of adjustment, from 0 (off) to 4 (maximum speed).

To go back to manual mode, the appliance has to be switched off and on again.

 Refer to the hood manual for further details.

## Settings menu

 The  and  refer to functions that can only be modified from the user menu.

The settings menu allows you to modify some of the operating characteristics of the appliance and allows you to carry out operations indicated below.

With the appliance switched off, press the button to access the settings menu. The scroll bar and the icons of settings that can be changed will be displayed:

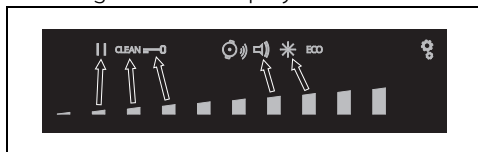



Individual settings can be selected using the segment of the scroll bar that is most directly below it.

Press the  button again to exit from the menu.

## Pause function

 This function pauses the operation of all the cooking zones.

To activate the Pause function:

1. Switch on at least one cooking zone.
2. Hold down the pause button . The symbol  displays on all the cooking zones.

To deactivate the Pause function:

1. Hold down the button . The pause symbol, which has just been pressed, starts to flash.
2. Press any button apart from the Pause button.
3. The pause function has now been deactivated and the previously set functions are restored.

 The cooking time limitation, the residual heat indicators and the control lock function remain enabled during the Pause function.

 When the power comes back on after a power failure, the pause function will be deactivated.

 The pause function can be maintained for a maximum of 10 minutes, after which the appliance switches off.

## Clean Function



At least one cooking zone must be active in order to activate the Clean function:

1. Access the settings menu.
2. Press the segment of the scroll bar below the **CLEAN** icon.
3. A 15-second countdown appears on the timer display, after which the appliance resumes with the previous settings.

Select any power level to deactivate the Warming function. Or press the  button.



 This function pauses the appliance for 15 seconds during which it is possible to remove dirt or stains. Be careful, as the surface may be hot.

## Controls lock



 This feature is designed to lock all the hob zones, except for the  and  buttons.

This is useful when cleaning the appliance and to prevent functions being modified by mistake.

To activate the controls Lock, carry out the following procedure:

4. Access the settings menu.
5. Press the segment of the scroll bar below the  icon.  appears on the displays of all the cooking zones.

To deactivate the controls lock, carry out the following procedure:

1. Access the settings menu
2. Press the segment of the scroll bar below the  icon. All the  symbols disappear.

### Button volume

1. Access the settings menu.
2. Press the segment of the scroll bar under the  icon.
3. Use the scroll bar to select the required volume.

### Display lighting





1. Access the settings menu.
2. Press the segment of the scroll bar under the  icon.
3. Use the scroll bar to select the required level of brightness.

### User menu

The user menu allows you to modify some operating characteristics of the appliance. There are 9 options available. Each option is marked with the letter "U" together with a progressive number on the timer display.

Option	Description
U0	Maximum total power (kW) - To be modified by the installer only
U1	Option disabled
U2	Button volume
U3	Timer alarm volume
U4	Display brightness
U5	Timer animation
U6	Automatic pan detection
U7	Timer alarm duration
U8	Hood fan configuration
U9	Auto-Vent 2.0 function

### Accessing the user menu

1. If the hob is off, switch it on using the  button.
2. Press  again to switch it off; the  button starts to flash.
3. Press and hold .
4. The following symbols appear on the cooking zone displays:

Press all the buttons of the cooking zones in sequence in a clockwise direction starting

from the front left. Every effective touch will be confirmed by a beep.

Models with 4 cooking zones:

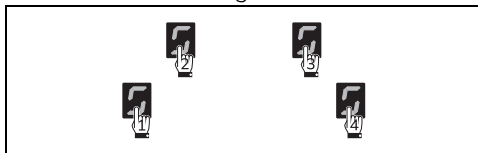

Models with 5 cooking zones:

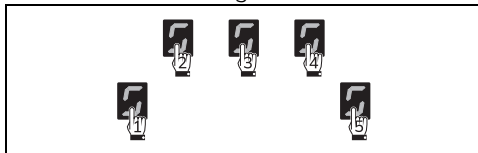



Press all the buttons of the cooking zones in sequence in a clockwise direction starting from the front left (1). A beep will sound to confirm every effective press of a button.



If the buttons are pressed in the incorrect order, the procedure for accessing the menu will have to be repeated from step 3.

5. Release the .

The user menu has been accessed and the  symbol alternating with the number  (option U0 - Power limitation) appears on the display of the rear left zone.

The total power of the appliance can be modified in steps of 0.1 kW (ECO-Logic Advance function).

The timer display indicates the default power setting (in kW): 7.4.

Press the timer display to enable changes to be made to the power settings. Then press the left half of the scroll bar to decrease the power and the right half to increase it. Keep the button pressed to reach the required setting more quickly.

- Press the  symbol to go back to selecting the options (rear left zone display).
- Press the segments of the scroll bar to

select an option.

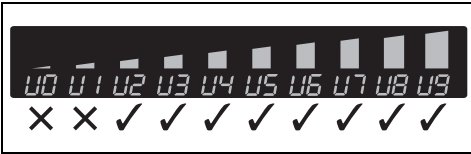

- The first segment on the left (option U0) is reserved for the power limitation procedure (installer only).
- For technical reasons, the second segment from the left (option U1) is disabled. Selecting this option will have no effect.



- After selecting an option, press the front left display to modify it.



According to the adjustment range of each option, the scroll bar will show only those segments that correspond to the adjustments available for each option.

### User options



Options U2 and U4 (that correspond to icons  and  respectively) can also be modified via the settings menu.

Option U2 modifies the volume of the button sounds; 4 sound levels can be selected using the scroll bar.

- 0: minimum volume.
- 3: maximum volume.

Option U3 modifies the volume of the sound signals when the timer has ended. 4 levels can be selected.

- 0: minimum volume.
- 3: maximum level.

Option U4 modifies the brightness of the display. 10 levels can be selected.

- 0: maximum brightness.
- 9: minimum brightness.

Option U5 allows you to modify the type of animation of the seconds countdown of the independent timer and timed cooking, from 59 to 0 seconds.



The seconds count is displayed when the timer is set to 1 minute.

- 0: animation 1.
- 1: animation 2.

Option U6 allows you to activate or deactivate the automatic pan detection

function. (see “Automatic cooking zone activation”).

- 0: automatic detection off.
- 1: automatic detection on.



If automatic pan detection is disabled, the area must be switched on manually when a pan is placed on the hob.

Option U7 specifies the length of the alarm when the timer has finished. 3 levels can be selected:

- 0: alarm duration 120 seconds.
- 1: alarm duration 10 seconds.
- 2: alarm disabled.

Option U8 allows you to activate the Auto-Vent 2.0 function in automatic mode. 8 levels can be selected. The following table summarises the possible settings:

Hardness level	Hood lighting	Hood fan speed		
		Delicate cooking	Medium cooking	Intense cooking
0	Off	Off		
1	On	Off		
2 - 4 - 6	On	Off	speed 1	speed 2
3 - 5 - 7	On	speed 1	Speed 2	Speed 3

Refer to the table below to select the most suitable value according to the power limitation of the appliance:

Hardness level	Power limitation
2 - 3	up to 4 kW
4 - 5	from 4 to 5 kW
6 - 7	5 kW upwards



If the appliance is set to a lower power level lower than the one indicated in the table above, it may not be possible to select some of the fan speeds.

Option U9 allows you to activate or deactivate the Auto-Vent 2.0 function:

- 0: function off.
- 1: function on.

### Exiting the user menu

There are two ways to exit from the user menu:

- 1 Press the  button. Any modifications will be discarded and the hob will be switched off.

Or

- 2 Press the  button for at least two seconds. The modifications will be saved and the hob will be switched off.

## Error notifications

If the appliance malfunctions or operates incorrectly, the associated error code appears on the display.

The error codes always begin with the letter “E” or “Er” followed by a series of digits (e.g. “Er47-30”).

Errors coded as:

- “E02”
- “E2”
- “Er21”

Indicate that the appliance or part of it is overheating. If this occurs, you should switch off the appliance immediately, remove all pans and let it cool down.

If these errors persist or if other errors appear, make a note of the code and contact Technical Support.

# CLEANING AND MAINTENANCE

## Cleaning the glass ceramic hob



See General safety instructions.

### Cleaning the surfaces

To keep the surfaces in good condition, they should be cleaned regularly after use. Let them cool first.

### Ordinary daily cleaning

Always and only use specific products that do not contain abrasives or chlorine-based acids. Pour the product onto a damp cloth and wipe the surface, rinse thoroughly and dry with a soft cloth or a microfibre cloth.



In case of stubborn dirt, clean when cold using a damp kitchen sponge and neutral detergent; then dry with a microfibre cloth.

### Weekly cleaning

Clean and maintain the hob once a week using an ordinary glass ceramic cleaning product. Always follow the manufacturer’s instructions. The silicon in these products creates a protective, water-repellent membrane which also resists dirt. All marks stay on the membrane and can therefore be removed easily. After cleaning, dry the surface with a clean cloth. Make sure that there is no detergent left on the cooking surface as it might undergo an aggressive reaction when heated up and could modify the structure of the cooking surface.

### Food stains or residues

Light coloured marks from pans with aluminium bases can be easily cleaned off with a cloth moistened in vinegar. Remove any burnt-on residues after cooking; then rinse with water and dry thoroughly with a clean cloth. Dirt, which may have fallen on the hob while cleaning lettuce or potatoes,

can scratch the hob when moving pans. Consequently, remove any dirt from the cooking surface immediately. Changes in colour do not affect the operation and stability of the glass. These are not alterations to the material of the hob but just residues which have not been removed and have then carbonised. Shiny surfaces can form due to the bases of pans, especially aluminium ones, rubbing on the surface, and due to the use of unsuitable detergents. They are difficult to remove using conventional cleaning products. It may be necessary to repeat the cleaning process several times. Use of corrosive detergents or rubbing of pan bases can wear away the decoration on the hob over time and contribute to the formation of stains.



We recommend the use of cleaning products distributed by the manufacturer.



After cleaning, dry the appliance thoroughly to prevent any water or detergent from interfering with its operation or creating unsightly marks.

## What to do if...

The hob does not work:

- Make sure that the hob is connected and that the main switch is turned on.
- Make sure that there is no power failure.
- Make sure that the fuse has not blown. In this case replace the fuse.
- Make sure that the circuit breaker of the residential electrical system has not tripped. In this case, reset the circuit breaker.

The cooking results are unsatisfactory:

- Make sure that the cooking temperature

- is not too high or too low.
- Make sure that the hob is properly ventilated and that the air inlets are unobstructed.
- Use cookware that is certified and tested for induction cooking.

The hob smokes:

- Let the hob cool down and clean it once cooking is complete.
- Make sure that the food has not spilled

out of the pan and use a larger cooking vessel, if needed.

The fuses blow or the circuit breaker of the residential electrical system trips repeatedly.

- Call Technical Support or an electrician.
- There are cracks or fissures in the hob:
- Turn off the appliance immediately, disconnect the power supply and contact Technical Support.

## INSTALLATION

### Electrical connection



See General safety instructions.

#### General information

Check the mains characteristics against the data indicated on the plate.

The identification plate bearing the technical data, serial number and brand name is visibly positioned on the appliance. Do not remove this plate for any reason.

The appliance must be connected to ground using a wire that is at least 20 mm longer than the other wires.

#### Terminal block connection

Arrange the cables in an orderly manner to avoid overlapping or contact with any jumpers. The cables must be of the correct length to avoid build-up/twisting inside the terminal box.

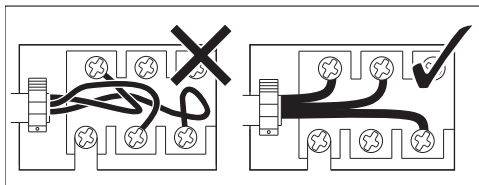

The device can be connected in the following ways:

80 cm models with 4 cooking zones

220-240V ~  
3 x 6 mm<sup>2</sup>  
three-core cable

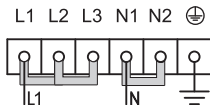

220V 2 ~  
3 x 6 mm<sup>2</sup>  
three-core cable

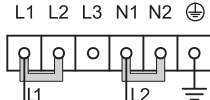

220-240V 3~  
4 x 4 mm<sup>2</sup>  
four-core cable

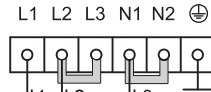

380-415V 2N~  
4 x 4 mm<sup>2</sup>  
four-core cable

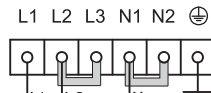

380-415V 3N~  
5 x 1.5 mm<sup>2</sup>  
five-core cable

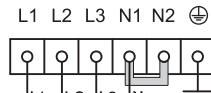

80 cm models with 5 cooking zones and 90 cm models

220-240V ~  
3 x 6 mm<sup>2</sup>  
three-core cable

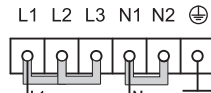

220-240V 3~  
4 x 6 mm<sup>2</sup>  
four-core cable

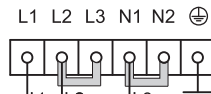

380-415V 2N~  
4 x 6 mm<sup>2</sup>  
four-core cable

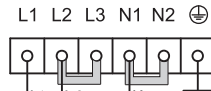

380-415V 3N~  
5 x 2.5 mm<sup>2</sup>  
five-core cable

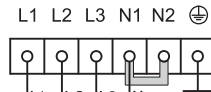

For all types of connection, use the jumper provided.



The values indicated refer to the cross-section of the internal lead.



The power cables are sized taking into account the coincidence factor (in compliance with standard EN 60335-2-6).

### Fixed connection

Fit the power line with an all-pole circuit breaker with a contact separation distance sufficient to provide complete disconnection in category III overvoltage conditions, pursuant to installation regulations.

### For the Australian/New Zealand market:

The circuit breaker incorporated in the fixed connection must comply with AS/NZS 3000.

## Section cut from the countertop

### Safety instructions for positioning and installation



See General safety instructions.

- Installation can be carried out on various materials such as masonry, metal, solid wood or plastic laminated wood as long as they are heat resistant (>90°C).
- Veneers, adhesives or plastic coatings on adjacent furniture should be temperature-resistant (>90°C), otherwise they might warp over time.
- If the piece of furniture does not have the required recess opening, either it will have to be cut or masonry work carried out by a competent technician.
- The minimum clearance between exhaust hoods and the cooking surface must be at least the distance indicated in the exhaust hood installation instructions.
- The minimum clearances must also be respected for the edges of the hob on the back as indicated in the assembly instructions.
- If the appliance is to be installed above an oven, the oven must be fitted with a cooling fan.

### Appliance overall dimensions (mm)

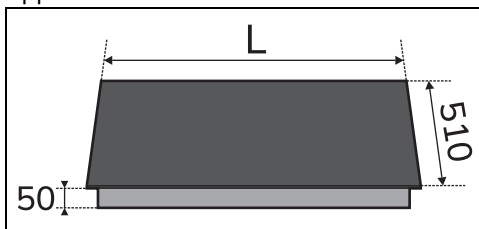

### Standard mounting (mm)

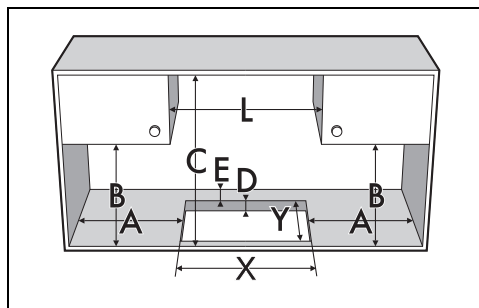

A	B	C	D	E
min 50	min 460	min 750	20 - 60	min 50

L	X	Y
800	750÷780	480÷490
900	839÷844	478÷482

### Flush mounting (mm)

For this type of mounting, you have to make an additional cut at the edges of the recess in the furniture if you wish to install the hob flush with the countertop.

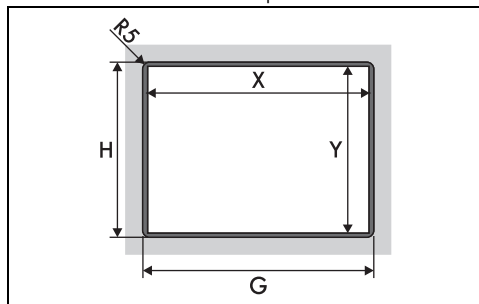

A	B	C	D	E
min 50	min 460	min 750	20 - 60	min 50

L	X	Y	G	H
800	730÷750	480÷490	803	513
900	840	478÷482	903	513

### Hob seal

To prevent leakage of liquid between the frame of the hob and the countertop, place the adhesive seal provided along the entire

outer edge of the hob before assembly.

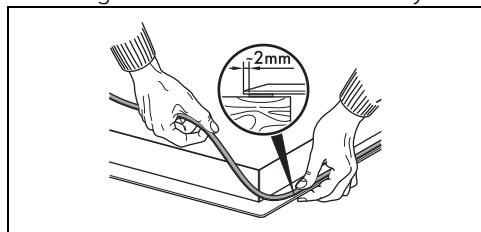

Do not use silicone to secure the hob. This would make it impossible to remove the hob without damaging it.

In the case of flush mounting, after placing the adhesive seal (A) on the glass surface and after positioning and securing the hob, fill the edges with insulating silicone (B) and wipe off any excess. If for any reason the hob needs to be removed, cut the silicone using a cutter before attempting to remove it (C).

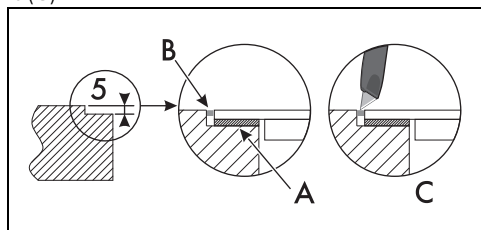

## Mounting

### On top of oven built-in unit

The clearance between the hob and the kitchen furniture or other installed appliances must be enough to ensure sufficient ventilation and air discharge. If installed above an oven, a space must be left between the bottom of the hob and the

top of the appliance installed below.

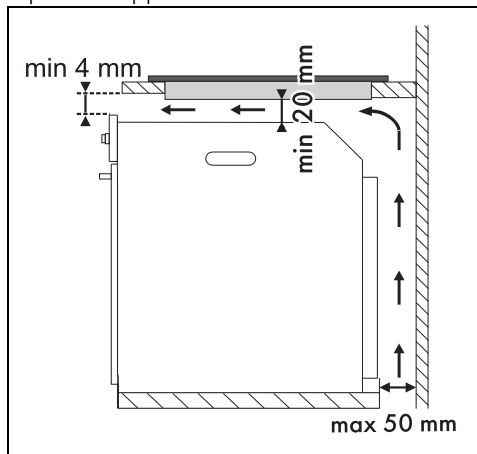

EN

### On top of empty kitchen unit or drawers

If there are other pieces of furniture (lateral walls, drawers, etc.), dishwashers or fridges under the hob, a double-layer wooden base must be installed at least 20 mm from the bottom of the hob to avoid any accidental contact. It must only be possible to remove the double-layer base using suitable equipment.

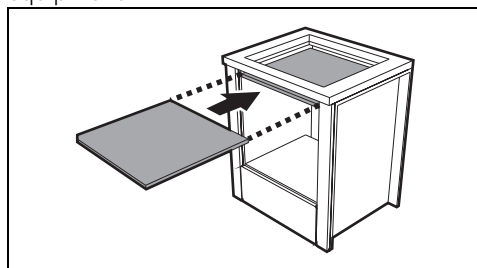

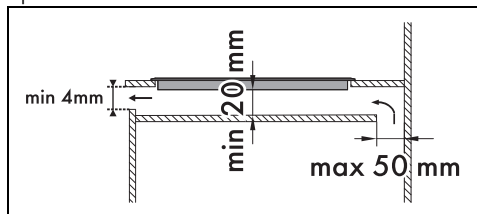

opens on bottom:

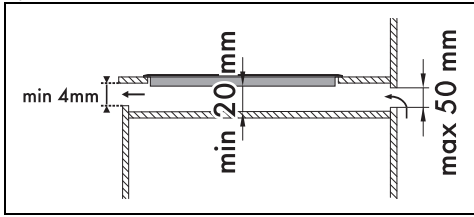

opens on rear:



 Failure to install the double-layer wooden base exposes the user to possible accidental contact with sharp or hot parts.

 If installed on top of an oven, the latter must be equipped with a cooling fan.

## Ventilation

The illustrations below show an example of installation suitable for proper ventilation and one example of incorrect installation to be avoided.

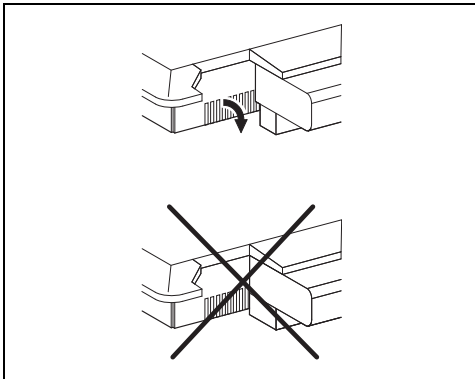

## Fixing to the built-in cabinet

 The clips should not be installed at the front of the appliance.

To ensure the hob is fixed and centred as accurately as possible, the clips provided must be positioned as described below:

1. Fit the clips by gently pressing them horizontally into the appropriate space.

2. Then turn them upwards to fix them in place.

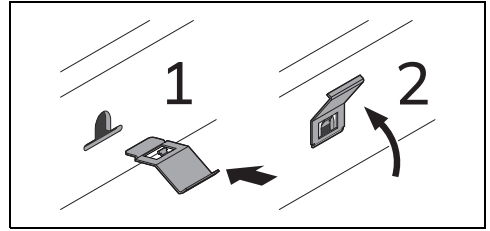

## Instructions for the installer

- If you use a plug (if present) to connect to the power supply, the plug must be accessible after installation.
- Do not bend or trap the power cable.
- The appliance must be installed according to the installation diagrams.
- If the appliance does not work correctly after having carried out all the checks, contact your local Authorised Service Centre.
- Once the appliance has been installed, please explain to the user how to use it correctly.