

DUCTLESS MINI SPLIT SYSTEM AIR CONDITIONER / HEAT PUMP

---

# PIONEER®

## UYB-20 Inverter Series

For 36,000-48,000 BTU/hr Systems

*Quantum Ultra (R-454B) - UB Indoor and YN Outdoor*

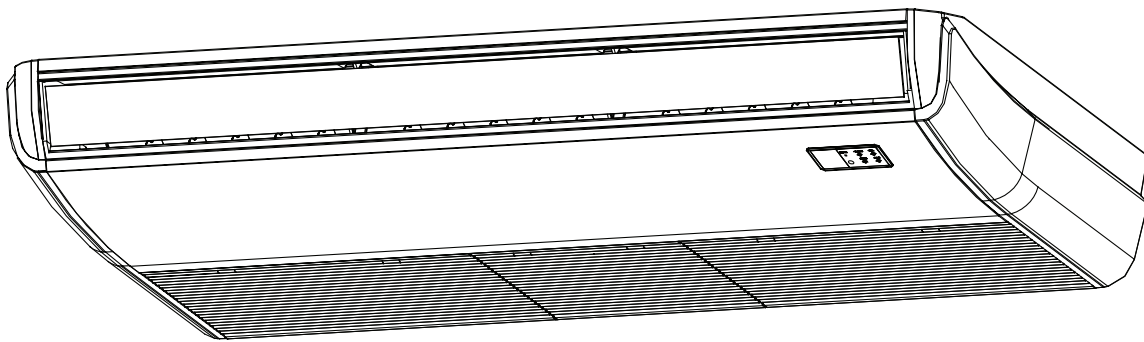

# Installation & User Manual

### IMPORTANT NOTICE:

Read this manual carefully before installing or operating your new air conditioning system. Be sure to save this manual for future reference.



REV250602

# Table of Contents

<b>1</b>	Safety Precautions.....	2
<b>2</b>	Product Overview.....	17
<b>3</b>	Product Installation.....	18
<b>4</b>	Indoor Unit Installation.....	20
	<b>5</b> Outdoor Unit Installation.....	27
	<b>6</b> Refrigerant Piping Connection.....	31
	<b>7</b> Wiring Precautions.....	35
	<b>8</b> Air Evacuation.....	39
	<b>9</b> Note on Adding Refrigerant.....	41
<b>10</b>	Test Run.....	42
<b>11</b>	Unpacking & Packing.....	44
<b>12</b>	Operation Instructions.....	45
<b>13</b>	Care & Maintenance.....	47
<b>T</b>	Troubleshooting.....	50

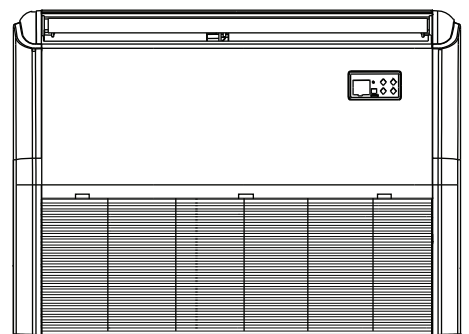
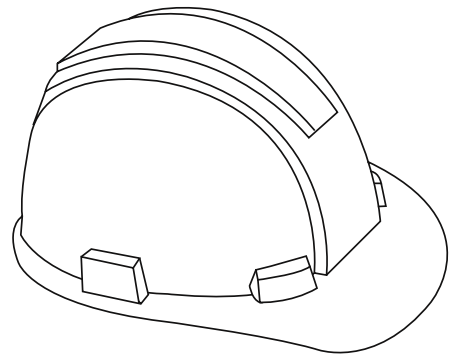

## Read this Manual

The manual provides helpful hints on using and maintaining the air conditioner properly. Performing preventive care can save time and money over the lifespan of the air conditioner. These instructions may not cover every possible condition of use, so common sense and attention to safety is required when installing, operating, and maintaining this product.

# Safety Precautions

# 1

It is important to read this section before operating and installing the system. Incorrect installation due to ignoring instructions can cause serious damage or injury. The seriousness of potential damage and injuries is classified as either a warning or caution.

## Explanation of Symbols



### WARNING

This symbol indicates the possibility of personal injury or loss of life.



### CAUTION

This symbol indicates the possibility of property damage or serious consequences.



### WARNING

Children aged 8 and above, as well as individuals with lack of experience or reduced physical, sensory, or mental capabilities can use the appliance if supervision or instruction is given. Do not allow children to play with or near the appliance. Children or untrained personnel should be restricted from cleaning and performing maintenance on the appliance, unless they're given supervision.



### WARNINGS FOR PRODUCT USE

- Turn off the air conditioner and disconnect the power before cleaning, installing, or repairing the system. Failure to do so can cause electric shock.
- If an abnormal situation arises (such as a burning smell), immediately turn off the unit and disconnect the power. Call the dealer for instructions to avoid electrical shock, fire, or injury.
- Do not insert fingers, rods, or other objects into the air inlet or outlet. This could cause injury because the fan rotates at high speeds.
- Do not use flammable sprays such as hair spray, lacquer, or paint near the unit. This may cause fire or combustion.
- Do not operate the air conditioner in locations near or around combustible gases. Emitted gas may collect around the unit and cause an explosion.
- Do not operate the air conditioner in a wet room such as a bathroom or laundry room. Too much exposure to water can cause electrical components to short circuit.
- Do not expose your body directly to cool air for prolonged durations of time.
- If the air conditioner is used together with burners or other heating devices, thoroughly ventilate the room to avoid oxygen deficiency.
- In certain functional environments (such as kitchens, server rooms, etc.), it is highly recommended to use specifically designed air-conditioning units.

# Safety Precautions

# 1

## WARNINGS FOR PRODUCT INSTALLATION

- Turn off the air conditioner and disconnect its power supply before installing or repairing the system. Failure to do so can cause electric shock.
- An authorized dealer or specialist must perform the installation. Incorrect installation can cause water leakage, electrical shock, or fire.
- Perform the installation according to the instructions in this manual. Improper installation can cause water leakage, electrical shock, or fire.
- Contact an authorized service technician to maintain and repair the unit.
- Install the appliance in accordance with national wiring regulations. Only use the included accessories, parts, and specified parts for installation. Using non-standard parts can cause water leakage, electrical shock, fire, or unit failure.
- Install the unit in a firm location that can support the unit's weight. If the chosen location cannot support the unit's weight or the installation is done incorrectly, the unit may drop and cause serious injury or damage.
- For units with an auxiliary electric heater, do not install the unit within 3 feet (1 m) of any combustible materials.
- For units that have a wireless network function (USB device access replacement), professional staff must carry out the maintenance operations.
- Do not install the unit in a location that may be exposed to combustible gas leaks. If combustible gas accumulates around the unit, it could cause fire.
- Do not turn on the power until all work has been completed.
- When moving or relocating the air conditioner, consult experienced service technicians for the disconnection and reinstallation of the unit.
- For information on installing the appliance to its support, read the Indoor Unit Installation and Outdoor Unit Installation sections.

## ELECTRICAL WARNINGS

- Only use the specified wire. If the wire is damaged, it must be replaced by the manufacturer, service agent, or a similarly qualified individual in order to avoid a hazard.
- Properly ground the product during installation to avoid electrical shock.
- Incorporate disconnection in the fixed wiring, according to the wiring rules.
- Do not share the electrical outlet with other appliances. Improper or insufficient power supply can cause fire or electric shock.

# Safety Precautions

# 1

- For all electrical work, follow the local and national wiring standards, regulations, and installation manual. Connect the cables tightly, then clamp them securely to prevent external forces from damaging the terminal. Improper electrical connections can result in electrical shock or fire. Complete the electrical connections according to the Electrical Connection diagram located on the panels of the indoor and outdoor units.
- Properly arrange all wiring to ensure that the control board cover can close correctly. If the control board cover is not closed properly, it can lead to corrosion and cause the connection points on the terminal to heat up and catch fire. It can also cause electrical shock.
- If connecting power to fixed wiring, incorporate an all-pole disconnection device in the fixed wiring. Ensure that the device is in accordance with the wiring rules.

## CLEANING & MAINTENANCE WARNINGS

- Turn off the device and disconnect its power supply before cleaning. Failure to do so can cause an electrical shock.
- Do not clean the air conditioner with excessive amounts of water.
- Do not clean the air conditioner with combustible cleaning agents. Combustible cleaning agents can cause fire or deformation.

## CAUTION

- Turn off the air conditioner and disconnect its power supply if the unit will not be used for a long duration of time.
- Turn off and unplug the unit during storms.
- Make sure that water condensation can drain unhindered from the unit.
- Do not operate the air conditioner with wet hands. This may cause electrical shock.
- Do not use the device for any other purpose than its intended use.
- Do not climb onto or place objects on top of the outdoor unit.
- Do not allow the air conditioner to operate for long periods of time with doors or windows open, or if the humidity is considerably high.

## TAKE NOTE OF FUSE SPECIFICATIONS

The air conditioner's circuit board (PCB) is designed with a fuse to provide overcurrent protection. The specifications of the fuse are printed on the circuit board. For example: T3.15AL/250VAC, T5AL/250VAC, T3.15A/250VAC, T5A/250VAC, T20A/250VAC, T30A/250VAC, etc.

**Note:** Only use the blast-proof ceramic fuse.

# Safety Precautions

# 1

## **⚠ WARNING FOR USING FLAMMABLE REFRIGERANTS**

- Do not use means to accelerate the defrosting process, other than those recommended by the manufacturer.
- Store the appliance in a room without continuously operating ignition sources. For example: open flames, an operating gas appliance, or an operating electric heater.
- Do not pierce or burn.
- Be aware that refrigerants may not contain an odor.

### **R-454B refrigerant charge amount and minimum room area:**

The machine you purchased may be one of the types listed in the table below. The indoor and outdoor units are designed to be used together. Check the machine that was purchased. Install the indoor unit at least 7.6 feet (2.3 m) above the floor. The height of the room cannot be less than the indoor unit's installed height. The minimum room area of operation or storage is as specified in the following table:

For the units with refrigerant sensors, when the unit detects a refrigerant leak, the minimum airflow of the indoor unit is as follows:

Model	Indoor Unit	Outdoor Unit
36K	UB036GMSILDFHG	YN036GMSI20RUG
48K	UB048GMSILDFHG	YN048GMSI20RUG

# Safety Precautions

# 1

**Note:** The air conditioner can be installed on the wall or suspended from the ceiling.

$A_{\min}$ [ft <sup>2</sup> / m <sup>2</sup> ]	$h_{\text{inst}}$ [ft/m]				
$m_c$ or $m_{\text{REL}}$ [ozs/kg]	6.0~7.3/ 1.8~2.2	7.9/2.4	8.6/2.6	9.2/2.8	9.9/3.0
≤62.6/1.776	12/1.10				
63.4/1.8	60/5.53	55/5.07	51/4.68	47/4.35	44/4.06
70.5/2.0	67/6.15	61/5.64	56/5.20	52/4.83	49/4.51
77.5/2.2	73/6.76	67/6.20	62/5.72	58/5.31	54/4.96
84.6/2.4	80/7.38	73/6.76	68/6.24	63/5.80	59/5.41
91.7/2.6	86/7.99	79/7.32	73/6.76	68/6.28	64/5.86
98.7/2.8	93/8.60	85/7.89	79/7.28	73/6.76	68/6.31
105.8/3.0	100/9.22	91/8.45	84/7.80	78/7.24	73/6.76
112.8/3.2	106/9.83	97/9.01	90/8.32	84/7.73	78/7.21
119.9/3.4	113/10.45	104/9.58	96/8.84	89/8.21	82/7.66
126.9/3.6	120/11.06	110/10.14	101/9.36	94/8.69	88/8.11
134/3.8	126/11.68	116/10.70	107/9.88	99/9.17	93/8.56
141.0/4.0	133/12.29	122/11.27	112/10.40	104/9.66	97/9.01
148.1/4.2	139/12.90	128/11.83	118/10.92	110/10.14	102/9.46
155.1/4.4	146/13.52	134/12.39	124/11.44	115/10.62	107/9.91
162.2/4.6	153/14.13	140/12.96	129/11.96	120/11.11	112/10.37
169.2/4.8	159/14.75	146/13.52	135/12.48	125/11.59	117/10.82
176.3/5.0	166/15.36	152/14.08	140/13.00	130/12.07	122/11.27
Area formula	<ul style="list-style-type: none"> <li>• <math>A_{\min}</math> is the required minimum room area in ft<sup>2</sup>/m<sup>2</sup>.</li> <li>• <math>M_c</math> is the actual refrigerant charge in the system in oz/kg</li> <li>• <math>M_{\text{REL}}</math> is the refrigerant releasable charge in oz/kg (applicable to the units with refrigerant sensors only)</li> <li>• <math>h_{\text{inst}}</math> is the height of the bottom of the appliance relative to the floor of the room after installation.</li> </ul> <p><b>WARNING:</b> The minimum room area or minimum room of conditioner space is based on the releasable charge and total system refrigerant charge.</p>				

# Safety Precautions

# 1

$A_{min}$ [ft <sup>2</sup> / m <sup>2</sup> ]	$h_{inst}$ [ft/m]		
$m_c$ or $m_{REL}$ [ozs/kg]	0	0.7~2.0 0.2-0.6	2.7~4.0 0.8~1.2
$\leq 62.6/1.776$		12/1.10	
63.4/1.8	60/5.53	60/5.53	60/5.53
70.5/2.0	67/6.15	67/6.15	67/6.15
77.5/2.2	73/6.76	73/6.76	73/6.76
84.6/2.4	80/7.38	80/7.38	80/7.38
91.7/2.6	86/7.99	86/7.99	86/7.99
98.7/2.8	93/8.60	93/8.60	93/8.60
105.8/3.0	100/9.22	100/9.22	100/9.22
112.8/3.2	106/9.83	106/9.83	106/9.83
119.9/3.4	113/10.45	113/10.45	113/10.45
126.9/3.6	120/11.06	120/11.06	120/11.06
134/3.8	126/11.68	126/11.68	126/11.68
141.0/4.0	133/12.29	133/12.29	133/12.29
148.1/4.2	139/12.90	139/12.90	139/12.90
155.1/4.4	146/13.52	146/13.52	146/13.52
162.2/4.6	153/14.13	153/14.13	153/14.13
169.2/4.8	159/14.75	159/14.75	159/14.75
176.3/5.0	166/15.36	166/15.36	166/15.36
Area formula	<ul style="list-style-type: none"> <li><math>A_{min}</math> is the required minimum room area in ft<sup>2</sup>/m<sup>2</sup>.</li> <li><math>M_c</math> is the actual refrigerant charge in the system in oz/kg</li> <li><math>M_{REL}</math> is the refrigerant releasable charge in oz/kg (applicable to the units with refrigerant sensors only)</li> <li><math>h_{inst}</math> is the height of the bottom of the appliance relative to the floor of the room after installation.</li> </ul> <p><b>WARNING:</b> The minimum room area or minimum room of conditioner space is based on the releasable charge and total system refrigerant charge.</p>		

When the unit detects a refrigerant leak, the minimum airflow of the indoor unit is the following:

Model	36K	48K
Nominal air volume	1224CFM 2080m <sup>3</sup> /h	1353CFM 2300m <sup>3</sup> /h

# Safety Precautions

# 1

## 1. Installation

(Where refrigerant pipes are allowed)

- Any individual who is involved with working on or breaking into a refrigerant circuit must hold a valid certificate from an industry-accredited assessment authority. The certificate authorizes the individual's competence for handling refrigerants safely in accordance with the specifications of an industry recognized assessment.
- Maintenance and repairs requiring the assistance of other skilled personnel must be carried out under the supervision of the individual competent in the use of flammable refrigerants.
- Keep the installation of pipe-work to a minimum.
- Protect the pipe-work from physical damage.
- Ensure that the refrigerant pipes comply with national gas regulations.
- Ensure that the mechanical connections are accessible for maintenance purposes.
- Do not allow foreign matter (oil, water, etc.) from entering the piping. In addition, when storing the piping, securely seal the opening by pinching, taping, etc.
- Competent individuals must carry out all working procedures that affect safety.
- Store the appliance in a well-ventilated area where the room size corresponds to the room area as specified for operation.
- Test the joints using detection equipment with a capability of 5g/year of refrigerant or better. After installation, ensure that the equipment is at a standstill and maintained under operating pressure, or at least the minimum standstill pressure.
- In cases that require mechanical ventilation, ensure that the ventilation openings are kept clear of obstruction.
- Leak Detection System Installed: Power the unit except for service.  
For units with refrigerant sensors, when the sensor detects refrigerant leakage, the indoor unit will display an error code and emit a buzzing sound, the outdoor unit's compressor will immediately stop, and the indoor fan will start running. The service life of the refrigerant sensor is 15 years. When the refrigerant sensor malfunctions, the indoor unit will display the "FHCC" error code. The refrigerant sensor cannot be repaired and can only be replaced by the manufacturer. Replace the sensor with one specified by the manufacturer.  
(Applicable to units with refrigerant sensors only.)

**2. When a flammable refrigerant is used**, the requirements for the installation space of the appliance and/or ventilation are determined according to the:

- Mass charge amount (M) used in the appliance.
- Installation location.
- Ventilation type of the location or appliance.
- Protect the piping material and pipe routing from physical damage during operation and service. Ensure that the piping material and pipe routing are in compliance with national and local codes and standards, such as ASHRAE 15, IAPMO Uniform Mechanical Code, ICC International Mechanical Code, or CSA B52. All field joints must be accessible for inspection prior to being covered or enclosed.
- Protect piping, fittings, and protection devices from adverse environmental effects. For example, water collecting and freezing in relief pipes or the accumulation of dirt and debris.

# Safety Precautions

# 1

- Ensure that the piping in the refrigerant system is designed and installed to minimize the likelihood of hydraulic shock damaging the system.
- Before applying any insulation, protect the steel pipes and components against corrosion with a rustproof coating.
- Take precautions to avoid excessive vibration or pulsation.
- The minimum floor area of the room is mentioned in the form of a table or single figure without reference to a formula.
- After completing the field piping for split systems, pressure test the field pipework with an inert gas. Then, vacuum test the pipework before refrigerant charging. Ensure that the testing is completed according to the following requirements:

The minimum test pressure for the low side of the system must be the low side design pressure and the minimum test pressure for the high side of the system must be the high side design pressure, unless the high side of the system cannot be isolated from the low side of the system. If the high side cannot be isolated from the low side of the system, the entire system must be pressure tested to the low side design pressure.

After the test, maintain the test pressure for at least 1 hour, ensuring that there is no decrease of pressure, which is indicated by the test gauge. Ensure that the test gauge resolution does not exceed 5% of the test pressure.

During the evacuation test, after achieving a vacuum level specified in the manual, isolate the refrigeration system from the vacuum pump and ensure that the pressure does not rise above 1,500 microns within 10 minutes. The appropriate vacuum pressure level is specified in the manual, and must not be less than 500 microns or the value required for compliance with national and local codes and standards. The codes and standards may vary between residential, commercial, and industrial buildings.

- Field-made refrigerant indoor joints must be tightness tested according to the following requirements: The test method must have a sensitivity of 5 grams per year of refrigerant or better under a pressure of at least 0.25 times the maximum allowable pressure. No leak should be detected.

### 3. Qualification of Workers

The working personnel must be qualified to perform any maintenance, service, and repair operations. Competent individuals must carry out working procedures that affect safety means. The competent individual must complete the training by national training organizations or manufacturers that are accredited to teach the relevant national competency standards set in legislation. The individual's competence must be documented by a certificate. All training must follow the ANNEX HH requirements of UL 60335-2-40 4th Edition.

Examples for such working procedures are:

- breaking into the refrigerating circuit.
- opening of sealed components.
- opening of ventilated enclosures.

### 4. Well-Ventilated Area

Before breaking into the system or conducting any hot work, ensure that the area is in the open or is adequately ventilated. Maintain a degree of ventilation while the work is being carried out. Ensure that the ventilation safely disperses any released refrigerant and preferably expels it externally into the atmosphere.

### 5. Cabling

Confirm that the cabling will not be subject to wear, corrosion, excessive pressure, vibration, sharp edges, or any other adverse environmental effects. The check should also take into account the effects of aging or continual vibration from sources such as compressors or fans.

# Safety Precautions

# 1

## 6. Detection of Flammable Refrigerants

Do not use potential sources of ignition for searching or detecting refrigerant leaks. Do not use a halide torch or detector using a naked flame. Ensure that the detector is not a potential source of ignition and is suitable for the refrigerant used. Leak detection equipment must be set at a percentage of the refrigerant LFL, and calibrated to the refrigerant employed. Confirm the appropriate percentage of gas (25% maximum).

The following leak detection methods are deemed acceptable for refrigerant systems:

**Electronic leak detectors:** This type of detector can detect refrigerant leaks. However, in the case of flammable refrigerants, the sensitivity may not be adequate and need recalibration. Calibrate the detection equipment in a refrigerant-free area.

**Leak detection fluids:** The bubble method and fluorescent method agents are examples of leak detection fluids. These are suitable to use with most refrigerants. Avoid using detergents containing chlorine as the chlorine may react with the refrigerant and corrode the copper pipe-work.

If a leak is suspected, remove or extinguish all naked flames.

If a refrigerant leak is found and requires brazing, recover all the refrigerant from the system or use the shut off valves to isolate the refrigerant in a part of the system remote from the leak. See the following instructions for removing refrigerant.

## 7. Removal and Evacuation

Use conventional procedures when breaking into the refrigerant circuit to make repairs or for any other purpose. However, for flammable refrigerants, it is important to follow this best practice since flammability is a consideration.

Follow this procedure:

- Safely remove refrigerant following local and national regulations.
- Evacuate.
- Purge the circuit with inert gas (optional for A2L).
- Evacuate (optional for A2L).
- Continuously flush or purge with inert gas when using a flame to open the circuit.
- Open the circuit.

Recover the refrigerant charge into the correct recovery cylinders if venting is not allowed by local and national codes. For appliances containing flammable refrigerants, purge the system with oxygen-free nitrogen to render the appliance safe from flammable refrigerants. If needed, repeat this process several times. Do not use compressed air or oxygen to purge refrigerant systems.

For appliances containing flammable refrigerants, purge the refrigerant by breaking the vacuum in the system with oxygen-free nitrogen and continuing to fill until the working pressure is achieved. Then, vent to atmosphere and finally pull down to a vacuum (optional for A2L). Repeat this process until no refrigerant is present within the system (optional for A2L). When using oxygen-free nitrogen, vent the system down to atmospheric pressure to enable work to take place. Ensure that the outlet for the vacuum pump is not close to any potential ignition sources and ventilation is available.

# Safety Precautions

# 1

## 8. Charging Procedures

In addition to conventional charging procedures, follow these requirements:

- Use only appropriate tools when completing work. In case of uncertainty, consult the manufacturer of the tools for information on use with flammable refrigerants.
- Ensure that the contamination of different refrigerants does not occur when using charging equipment. Hoses or lines must be as short as possible to minimize the amount of refrigerant contained in them.
- Keep the cylinders upright.
- Ensure that the refrigerant system is earthed before charging the system with refrigerant.
- Label the system when charging is complete (if not already).
- Take extreme care to not overfill the refrigeration system.
- Prior to recharging the system, it must be pressure tested with oxygen-free nitrogen. Leak test the system after completing the charging but prior to commissioning. Carry out a follow up leak test before leaving the site.

## 9. Recovery

When removing refrigerant from a system, either for servicing or decommissioning, it is recommended good practice to remove refrigerants safely. When transferring refrigerant into cylinders, ensure that only appropriate refrigerant recovery cylinders are employed. Ensure that the correct number of cylinders for holding the total system charge are available. Designate all the cylinders intended to be used.

## Servicing Information

### 1. Inspect the Area

Before working on systems containing flammable refrigerants, safety checks are required to ensure that the risk of ignition is minimized. The following precautions must be complied with prior to conducting repairs on the system.

### 2. Work Procedure

To minimize the risk of flammable gas or vapor presence, conduct work using controlled procedures.

### 3. General Work Area

Inform all maintenance staff and individuals working in the local area about the nature of the work being performed. Avoid working in confined spaces. Section off the area around the workspace. Ensure that the area is safe by controlling flammable materials.

### 4. Check for Refrigerant

Check the area with an appropriate refrigerant detector before and during work to ensure that the technician is aware of potentially flammable atmospheres. Ensure that the leak detection equipment is suitable for flammable refrigerants, i.e. non-sparking, adequately sealed, or intrinsically safe.

### 5. Fire Extinguisher

If conducting hot work on the refrigeration equipment or any associated parts is needed, appropriate fire extinguishing equipment must be available. Keep a dry powder or CO<sub>2</sub> fire extinguisher adjacent to the charging area.

# Safety Precautions

# 1

## 6. No Ignition Sources

Individuals carrying out work involving exposed pipework on a refrigerant system are prohibited from using any sources of ignition that may lead to a risk of fire or explosion. All possible ignition sources, such as cigarette smoking, must be performed at a sufficient distance from the installation or maintenance site. Before conducting work on the equipment, the surrounding area must be surveyed to ensure that there are no flammable hazards or ignition risks. No Smoking signs must be displayed.

## 7. Well-Ventilated Area

Ensure that the area is open and well-ventilated before accessing the system or performing any work that generates heat. Ventilation must be maintained to a certain degree while work is being carried out. The ventilation should safely disperse any released refrigerant and expel it externally into the atmosphere.

## 8. Inspect the Refrigeration Equipment

When changing electrical components, they must be fit-for-purpose and meet the correct specifications. Follow the manufacturer's maintenance and service guidelines at all times. If in doubt, consult the manufacturer's technical department for assistance.

For installations using flammable refrigerants, check the following:

- Ensure that the charge size is appropriate for the room in which the refrigerant-containing parts are installed.
- Confirm the ventilation machinery and outlets are operating adequately and not obstructed.
- If an indirect refrigerating circuit is being used, check the secondary circuit for the presence of refrigerant.
- Confirm the equipment markings are visible and legible. Correct markings and signs that are illegible.
- Install the refrigeration pipe or components in a position that minimizes the risk of corrosion from harmful substances, unless constructed of corrosion-resistant materials and suitably protected.

## 9. Inspect the Electrical Devices

Repairing and maintaining electrical components must include initial safety checks and component inspections. If a fault exists that could compromise safety, do not connect the electrical supply to the circuit until the fault is resolved. If the fault cannot be immediately corrected but it is necessary to continue operation, a temporary solution must be implemented. If a temporary solution is implemented, it must be reported to the owner of the equipment, ensuring both parties are informed.

Initial safety checks must include the following:

- Confirm the capacitors are discharged. Ensure that this is done in a safe manner to avoid the possibility of sparking.
- Ensure that no live electrical components and wiring are exposed while charging, recovering, or purging the system.
- Confirm there is continuity of earth bonding.

## 10. Replace Sealed Electrical Components If It's Damaged.

## 11. Replace Intrinsically Safe Components If It's Damaged.

## 12. Cabling

Confirm that the cabling will not be subject to wear, corrosion, excessive pressure, vibration, sharp edges, or any other adverse environmental effects. The check should also take into account the effects of aging or continual vibration from sources such as compressors or fans.

# Safety Precautions

# 1

## 13. Detection of Flammable Refrigerants

Do not use potential sources of ignition for searching or detecting refrigerant leaks. Do not use a halide torch or detector using a naked flame. Ensure that the detector is not a potential source of ignition and is suitable for the refrigerant used. Leak detection equipment must be set at a percentage of the refrigerant LFL, and calibrated to the refrigerant employed. Confirm the appropriate percentage of gas (25% maximum).

The following leak detection methods are deemed acceptable for refrigerant systems:

**Electronic leak detectors:** This detector can detect refrigerant leaks. However, in the case of flammable refrigerants, the sensitivity may not be adequate and need recalibration. Calibrate the detection equipment in a refrigerant-free area.

**Leak detection fluids:** The bubble method and fluorescent method agents are examples of leak detection fluids. These are suitable to use with most refrigerants. Avoid using detergents containing chlorine as the chlorine may react with the refrigerant and corrode the copper pipe-work.

If a leak is suspected, remove or extinguish all naked flames.

If a refrigerant leak is found and requires brazing, recover all the refrigerant from the system or use the shut off valves to isolate the refrigerant in a part of the system remote from the leak. See the following instructions for removing refrigerant.

## 14. Removal and Evacuation

Use conventional procedures when breaking into the refrigerant circuit to make repairs or for any other purpose. However, for flammable refrigerants, it is important to follow this best practice since flammability is a consideration.

Follow this procedure:

- Safely remove refrigerant following local and national regulations.
- Evacuate.
- Purge the circuit with inert gas (optional for A2L).
- Evacuate (optional for A2L).
- Continuously flush or purge with inert gas when using a flame to open the circuit.
- Open the circuit.

Recover the refrigerant charge into the correct recovery cylinders if venting is not allowed by local and national codes. For appliances containing flammable refrigerants, purge the system with oxygen-free nitrogen to render the appliance safe from flammable refrigerants. If needed, repeat this process several times. Do not use compressed air or oxygen to purge refrigerant systems.

For appliances containing flammable refrigerants, purge the refrigerant by breaking the vacuum in the system with oxygen-free nitrogen and continuing to fill until the working pressure is achieved. Then, vent to atmosphere and finally pull down to a vacuum (optional for A2L). Repeat this process until no refrigerant is within the system (optional for A2L). When using oxygen-free nitrogen, vent the system down to atmospheric pressure to enable work to take place. Ensure that the outlet for the vacuum pump is not close to any potential ignition sources and ventilation is available.

# Safety Precautions

# 1

## 15. Charging Procedures

In addition to conventional charging procedures, follow these requirements:

- Use only appropriate tools when completing work. In case of uncertainty, consult the manufacturer of the tools for use with flammable refrigerants.
- Ensure that the contamination of different refrigerants does not occur when using charging equipment. Hoses or lines must be as short as possible to minimize the amount of refrigerant contained in them.
- Keep the cylinders upright.
- Ensure that the refrigerant system is earthed before charging the system with refrigerant.
- Label the system when charging is complete (if not already).
- Take extreme care to not overfill the refrigeration system.
- Prior to recharging the system, it must be pressure tested with oxygen-free nitrogen. Leak test the system after completing the charging but prior to commissioning. Carry out a follow-up leak test before leaving the site.

## 16. Decommissioning

Before carrying out this procedure, it is essential that the technician is completely familiar with the equipment and all its details. It is recommended good practice that all refrigerants are recovered safely. Prior to carrying out the task, take an oil and refrigerant sample in case an analysis is required prior to re-using the recovered refrigerant. It is essential that electrical power is available before the task is commenced.

Ⓐ Become familiar with the equipment and its operations.

Ⓐ Isolate the system electrically.

Ⓐ Before attempting the procedure ensure that

- Mechanical handling equipment is available for handling refrigerant cylinders.
- All personal protective equipment is available and being used correctly.
- A competent individual is supervising the recovery process at all times.
- Recovery equipment and cylinders conform to the appropriate standards.

Ⓐ Pump down the refrigerant system, if possible.

Ⓐ If a vacuum is not possible, make a manifold so that the refrigerant can be removed from various parts of the system.

Ⓐ Make sure that the cylinder is situated on the scales before recovery takes place.

\* Start the recovery machine and operate it in accordance with the instructions.

Ⓐ Do not overfill cylinders (no more than 80% volume liquid charge).

Ⓐ Do not exceed the maximum working pressure of the cylinder, even temporarily.

Ⓐ When the cylinders have been filled correctly and the process is completed, make sure that the cylinders and equipment are removed from the site promptly and all isolation valves on the equipment are closed off.

Ⓐ Do not charge recovered refrigerant into another refrigeration system unless it has been cleaned and checked.

# Safety Precautions

# 1

## 17. Labeling

Label the equipment stating that it has been de-commissioned and emptied of refrigerant. Make sure to date and sign the label. For appliances containing flammable refrigerants, ensure that there are labels on the equipment stating it contains flammable refrigerant.

## 18. Recovery

When removing refrigerant from a system, either for servicing or decommissioning, it is recommended good practice to remove refrigerants safely. When transferring refrigerant into cylinders, ensure that only appropriate refrigerant recovery cylinders are employed. Ensure that the correct number of cylinders for holding the total system charge are available. Designate all the cylinders intended to be used for the recovered refrigerant and label them for that refrigerant (i.e., special cylinders for the recovery of refrigerant). Cylinders must be complete with pressure-relief valves. The associated shut-off valves must be in good working order. Evacuate empty recovery cylinders and, if possible, allow them to cool before recovery occurs.

The recovery equipment must be in good working condition with a set of instructions concerning the equipment that is at hand. In addition, the recovery equipment must be suitable for the recovery of the flammable refrigerant. If in doubt, consult the manufacturer. In addition, a set of calibrated weighing scales must be available and in good working order. Hoses must be complete with leak-free disconnect couplings and in good condition.

The recovered refrigerant must be processed according to local legislation in the correct recovery cylinder. In addition, the relevant waste transfer note must be arranged. Do not mix refrigerants in the recovery unit and especially not in the cylinders.

If removing compressors or compressor oils, ensure that they have been evacuated to an acceptable level to make sure that flammable refrigerant does not remain with the lubricant. The compressor body must not be heated by an open flame or other ignition sources to accelerate this process. When oil is drained from a system, it must be carried out safely.





## 19. Transportation, Marking, and Storage for Units

- Transport equipment containing flammable refrigerants (Compliance with the transport regulations).
- Mark the equipment using signs (Compliance with local regulations).
- Dispose of equipment using flammable refrigerants (Compliance with national regulations).
- Store the equipment/appliance (Compliance with the manufacturer's instructions).
- Store packed (unsold) equipment. Construct the storage package protection in a way that potential mechanical damage to the equipment inside the package will not cause a leak of the refrigerant charge. Local regulations determine the maximum amount of equipment permitted to be stored together.

# Safety Precautions

# 1

## Explanation of symbols displayed on the indoor or outdoor units

	<b>WARNING</b>	This symbol shows that this appliance used a flammable refrigerant. If the refrigerant is leaked and exposed to an external ignition source, there is a risk of fire.
	<b>CAUTION</b>	This symbol shows that the operation manual should be read carefully.
	<b>CAUTION</b>	This symbol shows that a service personnel should be handling this equipment with reference to this manual.
	<b>CAUTION</b>	
	<b>CAUTION</b>	This symbol shows that information is available such as the operating manual or installation manual.

# Product Overview

# 2



## Note on Illustrations:

Illustrations in this manual are for explanatory purposes. The actual shape of the indoor unit may be slightly different. The actual shape shall prevail. Perform the installation in accordance with the requirements of local and national standards. The installation may be slightly different in different areas.

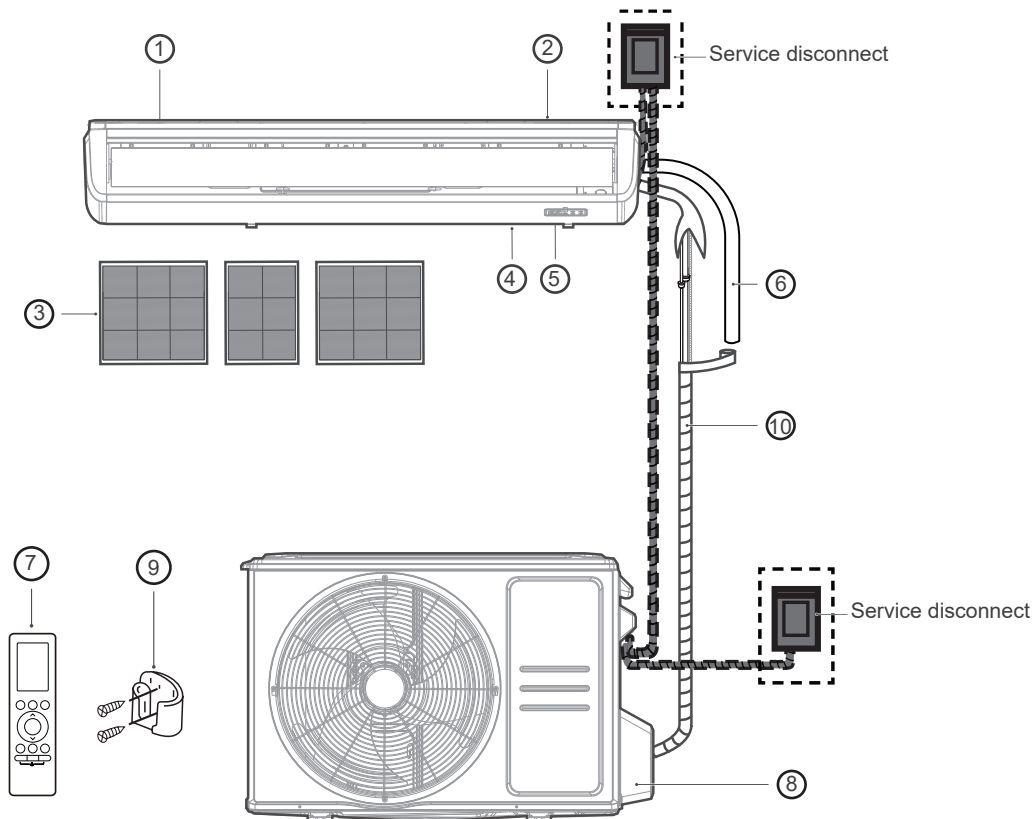

**Note:** Select a service disconnect meeting the requirements of the local, regional, and national codes.

- |                                     |                     |  |
|-------------------------------------|---------------------|--|
| ① Air flow louver (air outlet)      | ⑤ Display panel     | ⑨ Remote controller holder (purchase separately) |
| ② Installation part                 | ⑥ Drain pipe        | ⑩ Refrigerant piping (purchase separately)       |
| ③ Air filter                        | ⑦ Remote controller |  |
| ④ Air inlet (with air filter in it) | ⑧ Outdoor unit      |  |

## It would be perfect to have these tools



Gloves



Screwdriver & wrench

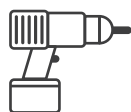

Hammer drill

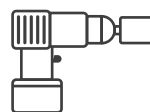

Core drill



Goggles & masks

















Vinyl tape

# Product Installation

# 3

## Accessories

The air conditioning system comes with the following accessories. Use all of the installation parts and accessories to properly install the air conditioner. Improper installation may result in water leakage, electrical shock and fire, or equipment failure. The items that are not included with the air conditioner must be purchased separately.

Name of Accessories	Qty	Shape	Name of Accessories	Qty	Shape
Manual	3		Remote controller	1	
Soundproof/insulation sheath	1		Battery	2	
Outlet pipe sheath	1		Remote controller holder (purchase separately)	1	
Outlet pipe clasp	2		Fixing screw for remote controller holder (purchase separately)	2	
Drain joint	1		Magnetic ring	1	
Seal ring (Not available for the outdoor unit with dimensions of 38.58 in x 38.39 in x 16.34 in)	1		Copper nut	2	
Conduit installation plate	1				
Installation plate	1		Rubber ring	3	

## Optional Accessories

There are two types of remote controls: Wired and wireless.

Select a remote controller based on customer preferences and requirements. Install the remote control in an appropriate place. Refer to catalogues and technical literature for guidance on selecting a suitable remote controller.

Name	Model	Pipe Specification		Remark
		Liquid Side	Gas Side	
Connecting pipe assembly	36K	Ø3/8 in (Ø9.52 mm)	Ø3/4 in (Ø19 mm)	Pipes are not included in the accessories and need to be purchased separately from the local dealer.
	48K	Ø3/8 in (Ø9.52 mm)	Ø3/4 in (Ø19 mm)	

# Product Installation

# 3

## Installation Summary

1

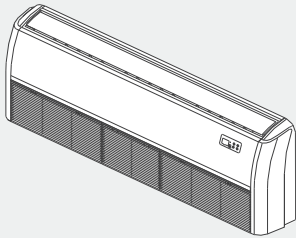

Install the indoor unit

2

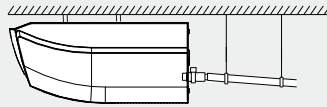

Install the drain pipe

3

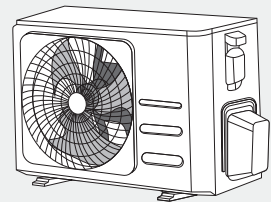

Install the outdoor unit

4

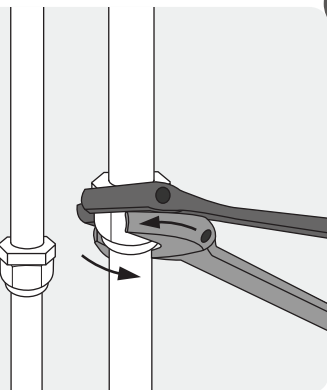

Connect the refrigerant pipes

5

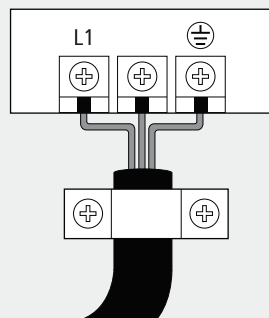

Connect the wires

6

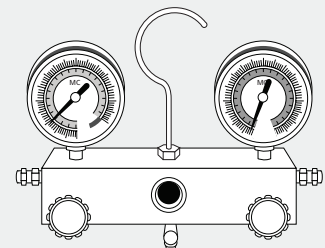

Evacuate the refrigeration system

7

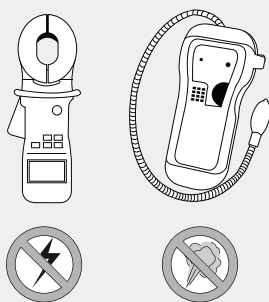

Perform a test run

# Indoor Unit Installation

# 4

## 1 Select the Installation Location

### Note:

Before installing the indoor unit, choose an appropriate location. The following are standards that will help in choosing an appropriate location for the unit.

### Before Installation:

- Determine the route for moving the unit to the installation site.
- First, unseal and unpack the unit. Then, hold the seats of the hanger (4 pieces) to move the unit. Refrain from exerting force on other parts of the unit, especially the refrigerant piping, water discharge piping, and plastic parts.

### Proper installation locations must meet the following standards:



Enough room exists for installation and maintenance.

Enough room exists for connecting the pipe and drainpipe.



There is no direct radiation from heaters.



The air inlet and outlet are not blocked.

The airflow can fill the entire room.

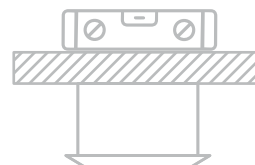

The ceiling is horizontal and its structure can sustain the weight of the indoor unit.

### Do not install the unit in the following locations:

- ⊘ Areas with oil drilling or fracking
- ⊘ Coastal areas with high salt content in the air
- ⊘ Areas with caustic gases in the air, such as hot springs
- ⊘ Areas that experience power fluctuations, such as factories
- ⊘ Enclosed spaces, such as cabinets
- ⊘ Kitchens that use natural gas
- ⊘ Areas with strong electromagnetic waves
- ⊘ Areas that store flammable materials or gas
- ⊘ Rooms with high humidity, such as bathrooms or laundry rooms

# Indoor Unit Installation

# 4

## 2 Confirm Various Sizes

### Recommended Distances Between the Indoor Unit

The distance between the mounted indoor unit must meet the specifications illustrated in the following diagram:

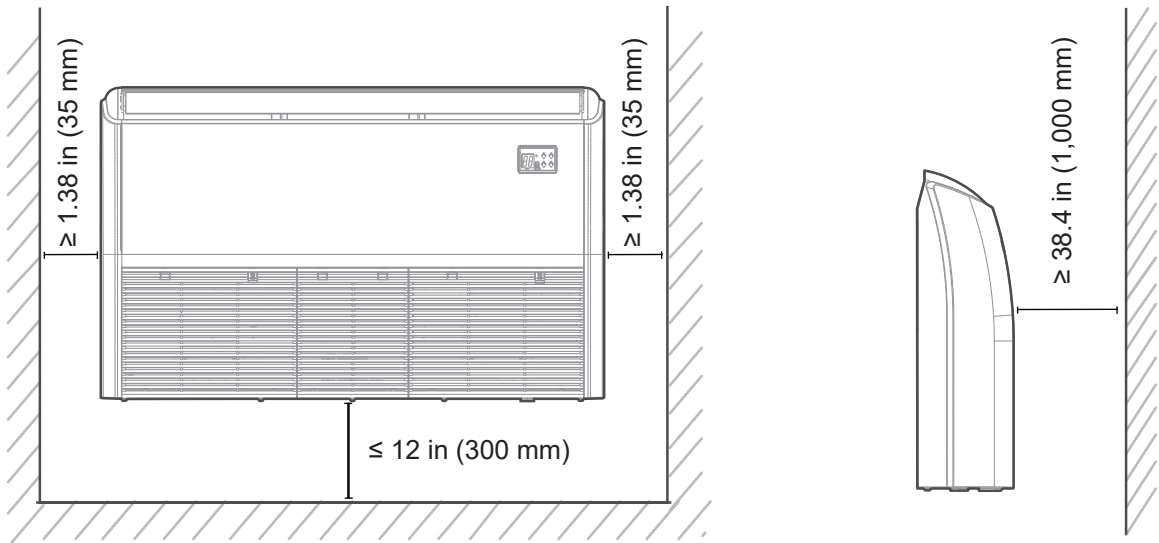

### Indoor Parts Installation Size

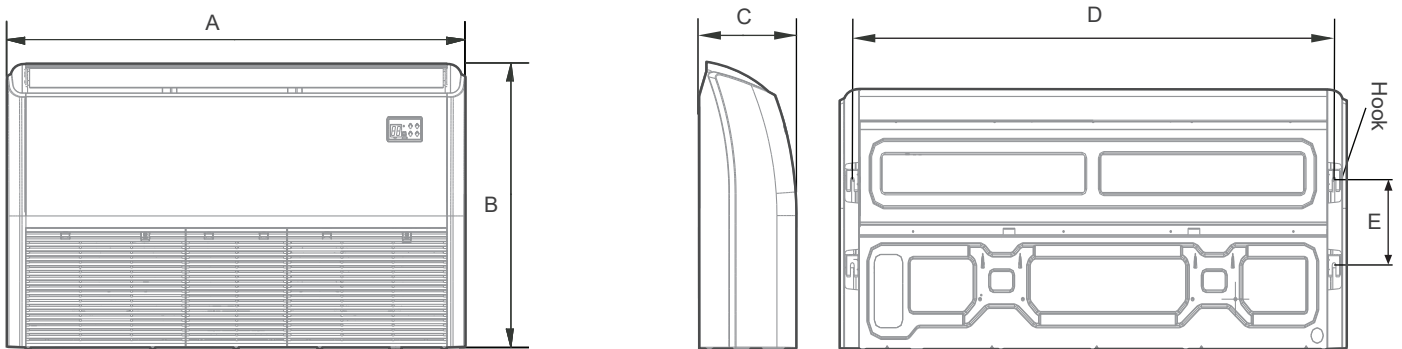

MODEL (Btu/h)	Length of A (inch/mm)	Length of B (inch/mm)	Length of C (inch/mm)	Length of D (inch/mm)	Length of E (inch/mm)
36K~48K	65/1650	26.6/675	9.3/235	61.6/1565	8.7/220



# Indoor Unit Installation

# 4

## 3 Hang the Indoor Unit

### Wooden Structure Installation

Place the wood mounting across the roof beam, then install the hanging screw bolts.

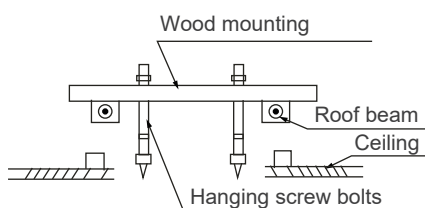

### Original Concrete Bricks

Install the hanging hook with the expansible bolt into the concrete. Ensure it's installed at a depth of 17.7-19.7 inches (45-50 mm) to prevent loosening.

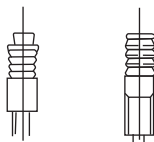

### New Concrete Bricks

Inlay or embed the screw bolts.

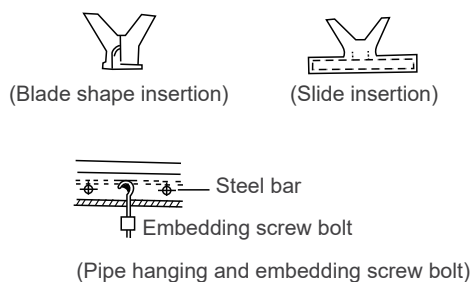

### Steel Roof Beam Structure

Install and use the supporting steel angle.

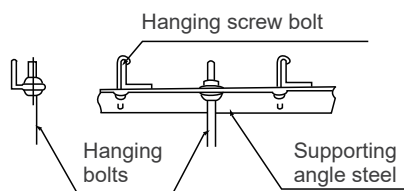

**Note:** Completely align the unit body with the hole. Ensure that the unit and hole are the same size before moving on.

1. Install and fit the pipes and wires after finishing the installation of the main body. When choosing where to start, determine the direction of the pipes to be drawn out. Especially in cases where there is a ceiling involved, align the refrigerant pipes, drain pipes, and indoor and outdoor lines with their connection points before mounting the unit.

2. Install the hanging screw bolts.

- Cut off the roof beam.
- Strengthen the area at which the cut was made and consolidate the roof beam.

3. After selecting the installation location, position the refrigerant pipes, drain pipes, and indoor and outdoor wires to the connection points before mounting the machine.

4. Drill four holes 4 inches (102 mm) deep at the ceiling hook positions into the internal ceiling. Be sure to hold the drill at a 90° angle to the ceiling.

5. Secure the bolt using the included washers and nuts.

6. Install the four suspension bolts.

7. Mount the indoor unit. Two people will be needed to lift and secure it. Insert suspension bolts into the unit's hanging holes. Fasten them using the included washers and nuts.

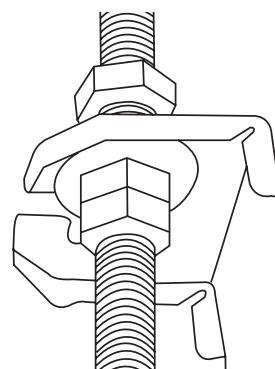

# 4

## Indoor Unit Installation

8. Remove the side board and grille.

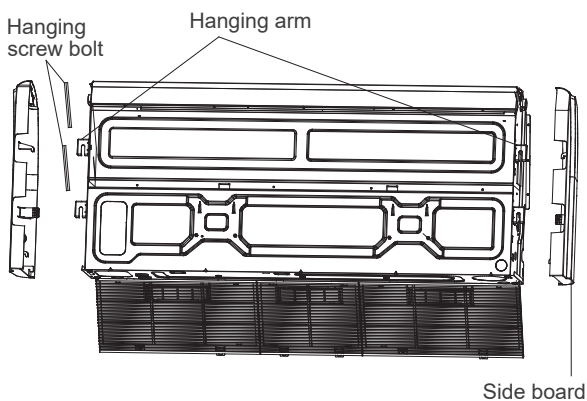

9. Mount the indoor unit onto the hanging screw bolts with a block. Position the indoor unit on a flat level by using a level to prevent leaks.

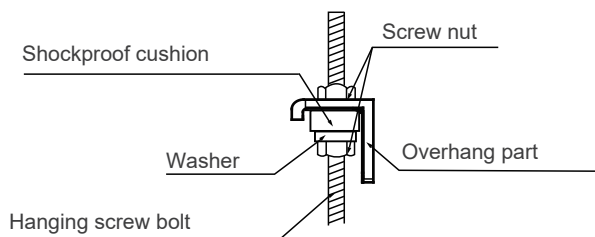

**Note:** Confirm the minimum drain tilt is 1/100 or more.

### Ceiling Installation

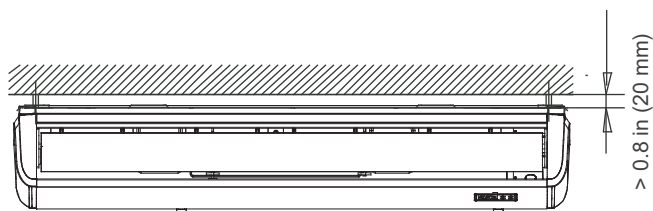

How to install the conduit installation plate (if supplied)

1. Fix the sheath connector of conduit on the wire hole of the conduit installation plate (not supplied).
2. Fix the conduit installation plate on the chassis of the unit.

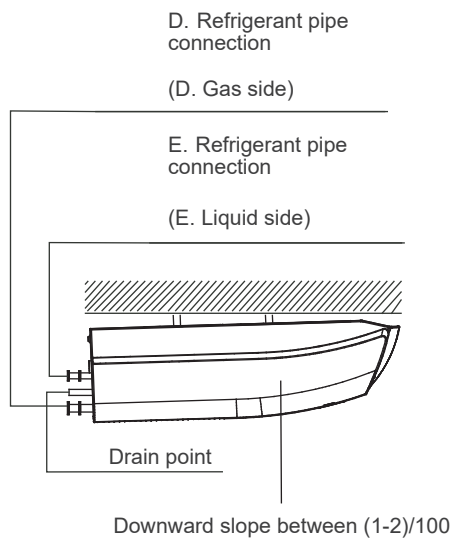
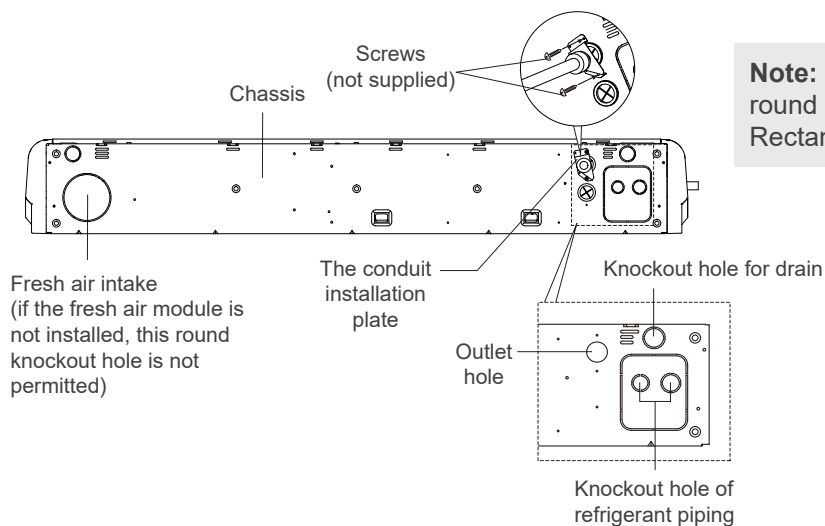

**Note:** When installing, open the corresponding round knockout holes as shown in the illustration. Rectangular knockout holes are not permitted.

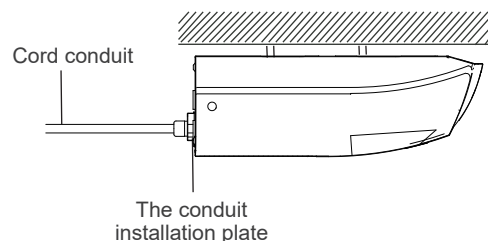

# Indoor Unit Installation

# 4

## Wall-Mounted Installation

How to install the conduit installation plate (if supplied)

1. Fix the sheath connector of conduit on the wire hole of the conduit installation plate (not supplied).
2. Fix the conduit installation plate on the chassis of the unit.

**Note:** When installing, open the corresponding round knockout holes as shown in the illustration. Rectangular knockout holes are not permitted.

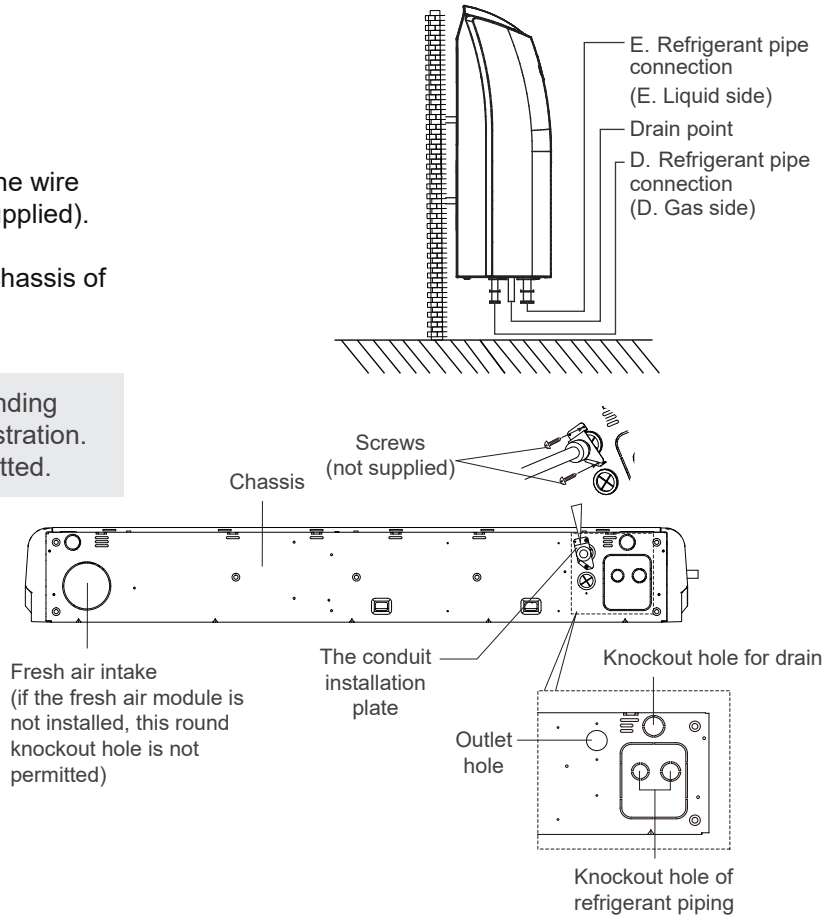

## The Wire Hole

1. Rubber rings are used to block the excess space in the three crossing holes of the electronic control box.
2. The installation plate is used to block the outlet holes at the bottom of the base when out of the side line.

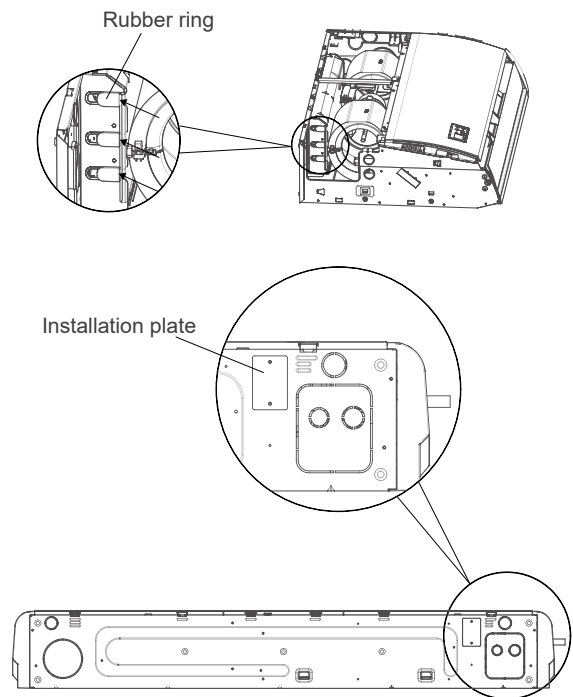

# Indoor Unit Installation

# 4

## 4 Drill the Wall Hole & Connect the Drain Piping

1. Determine the location of the wall hole based on the location of the outdoor unit.
2. Use a 2.5 or 3.54 inch core drill to create a hole in the wall. Make sure that the holes drilled at a slight downward angle, so that the outdoor end of the hole is lower than the indoor end by about a 0.5 inch. This will ensure proper water drainage.
3. Place the protective wall cuff in the hole. This protects the edges of the hole and will help seal it when finishing the installation process.

### ⚠ CAUTION

When drilling the wall hole, make sure to avoid wires, plumbing, and other sensitive components.

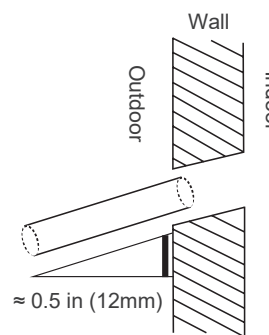

## Connect the Drain Hose

Use the drainpipe to drain water away from the unit. Improper installation may cause unit and property damage.

### Note on Purchasing Pipes:

Installation requires a polyethylene tube, which can be obtained at a local hardware store or dealer.

Exterior diameter = 1.46-1.54 in / 37-39 mm

Interior diameter = 1.26 in / 32 mm

### ⚠ CAUTION

- Insulate all piping to prevent condensation, which could lead to water damage.
- If the drainpipe is bent or installed incorrectly, water may leak and cause a water-level switch malfunction.
- In Heating mode, the outdoor unit will discharge water. Ensure that the drain hose is placed in an appropriate area to avoid water damage and slippage.
- Do not pull the drainpipe forcefully. This could disconnect it.

# Indoor Unit Installation

# 4

## Indoor Drainpipe Installation

Install the drainpipe as illustrated in the following figure.

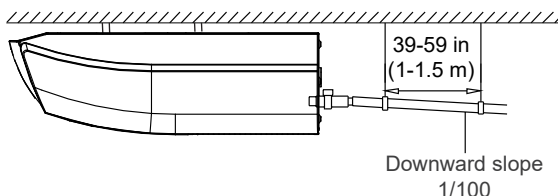

1. Cover the drainpipe with heat insulation to prevent condensation and leakage.
2. Attach the mouth of the drain hose to the unit's outlet pipe. Sheath the mouth of the hose and clip it firmly with a pipe clasp.

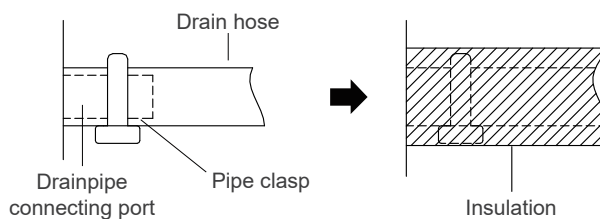

3. Pass the drain hose through the wall hole. Make sure the water drains to a safe location where it will not cause water damage or a slipping hazard.



### Note on Drainpipe Installation:

- When using an extended drainpipe, tighten the indoor connection with an additional protection tube to prevent it from pulling loose.
- The drainpipe should slope downward at a gradient of at least 1/100 to prevent water from flowing back into the air conditioner.
- To prevent the pipe from sagging, space hanging wires every 3.3-4.9 feet (1-1.5 m).
- Incorrect installation could cause water to flow back into the unit and flood.

**Note:** When connecting multiple drainpipes, install the pipes as illustrated in the above figure.

**Note:** The drainpipe outlet should be at least 1.9 inches (50 mm) above the ground. If it touches the ground, the unit may become blocked and malfunction. If water is discharged directly into a sewer, make sure that the drain has a U or S pipe to catch odors that might otherwise come back into the house.

# Outdoor Unit Installation

# 5

## 1 Select the Installation Location



### Note: Prior to Installation

Before installing the outdoor unit, choose an appropriate location. The following are standards intended to help select an appropriate location for the unit.

Proper installation locations must meet the following standards:

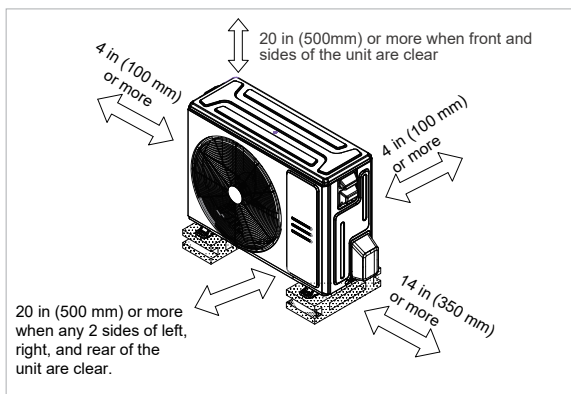

Good air circulation and ventilation.



Firm and solid—the location can support the unit and will not vibrate.



Noise from the unit will not disturb other people.



Protected from prolonged periods of direct sunlight or rain.



Where snowfall is anticipated, take appropriate measures to prevent ice buildup and coil damage.

Meets all spatial requirements shown in the installation clearance requirements above.

**Note:** Install the unit by following local codes and regulations, which can differ slightly between different regions.

### CAUTION:

#### Special Considerations for Extreme Weather

##### If the unit is exposed to heavy wind:

Install the unit so that the air outlet fan is at 90° angle to the direction of the wind. If needed, build a barrier in front of the unit to protect it from extremely heavy winds. See the figures below:

##### If the unit is frequently exposed to heavy rain or snow:

Build a shelter above the unit to protect it from rain or snow. Be careful not to obstruct air flow around the unit.

##### If the unit is frequently exposed to salty air (seaside):

Use an outdoor unit that is specially designed to resist corrosion.

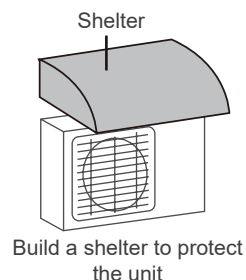
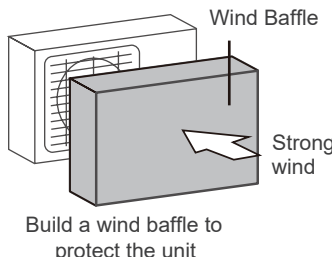
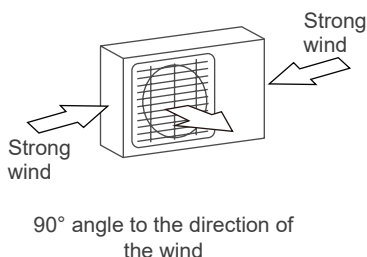

# Outdoor Unit Installation

# 5

Do not install the unit in the following locations:

- ⊘ Near an obstacle that will block air inlets and outlets.
- ⊘ Near animals or plants that will be harmed by hot air discharge.
- ⊘ In a location that is exposed to large amounts of dust.
- ⊘ Near public streets, crowded areas, or where noise from the unit will disturb others.
- ⊘ Near any source of combustible gas.
- ⊘ In a location exposed to an excessive amount of salty air.

## 2 Install the Drain Joint (Heat Pump Unit Only)

Before bolting the outdoor unit in place, install the drain joint at the bottom of the unit.

**Note:** There are two different types of drain joints depending on the type of outdoor unit.

**If the drain joint comes with a rubber seal (Figure A), do the following:**

1. Fit the rubber seal on the end of the drain joint that will connect to the outdoor unit.
2. Insert the drain joint into the hole of the unit's base pan.
3. Rotate the drain joint 90° until it clicks into place facing the front of the unit.
4. Connect a drain hose extension (not included) to the drain joint in order to redirect water from the unit during Heating mode.

**If the drain joint does not come with a rubber seal (Figure B), do the following:**

1. Insert the drain joint into the hole of the base pan, then press firmly to ensure it is properly installed and does not become loose.
2. Connect a drain hose extension (not included) to the drain joint in order to redirect water from the unit during Heating mode.

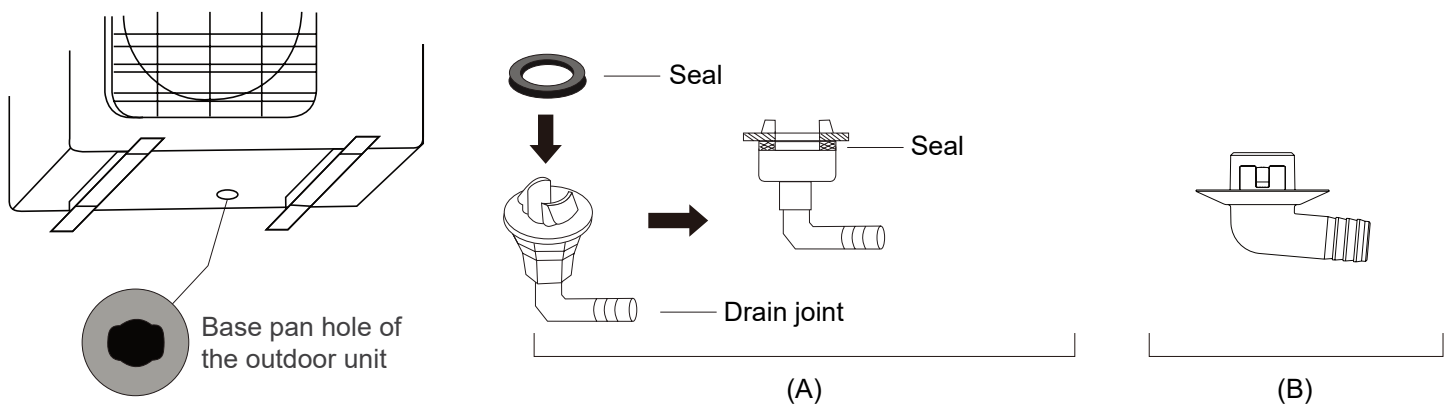

### ! In Cold Climates

In cold climates, make sure that the drain hose is as vertical as possible to ensure swift water drainage. If water drains too slowly, it can freeze in the hose and flood into the unit.

# Outdoor Unit Installation

# 5

## 3 Anchor the Outdoor Unit

### ⚠ WARNING

When drilling into concrete, eye protection is recommended at all time.

Anchor the outdoor unit to the ground or a wall-mounted bracket with bolts (M10). Prepare the installation base of the unit according to the dimensions below.

The following is a list of different outdoor unit sizes and the distance between their mounting feet. Prepare the installation base of the unit according to the dimensions below.

### Outdoor Unit Types & Specifications (Split Type Outdoor Unit)

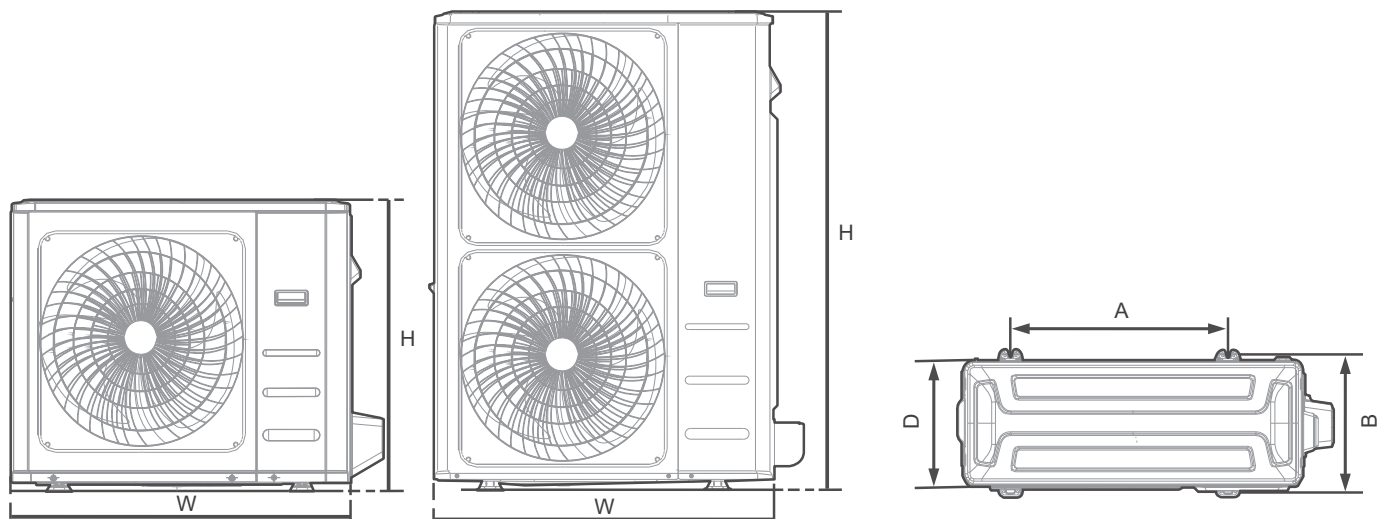

Front View

Top View

Outdoor Unit Dimensions W x H x D	Mounting Dimensions	
	Distance A	Distance B
30.1 in x 21.8 in x 11.9 in (765 mm x 555 mm x 303 mm)	17.8 in (452 mm)	11.3 in (286 mm)
31.7 in x 21.8 in x 12.9 in (805 mm x 555 mm x 330 mm)	20.1 in (511 mm)	12.5 in (317 mm)
35.0 in x 26.5 in x 13.5 in (890 mm x 673 mm x 342 mm)	26.1 in (663 mm)	13.9 in (354 mm)
37.24 in x 31.9 in x 16.53 in (946 mm x 810 mm x 420 mm)	26.5 in (673 mm)	15.87 in (403 mm)
38.58 in x 38.39 in x 16.34 in (980 mm x 975 mm x 415 mm)	24.25 in (616 mm)	15.63 in (397 mm)
37.5 in x 52.5 in x 16.34 in (952 mm x 1,333 mm x 415 mm)	24.96 in (634 mm)	15.9 in (404 mm)



# Outdoor Unit Installation

# 5

## Rows of Series Installation

	L	A
$L \leq H$	$L \leq 1/2H$	9.8 in (248.9 mm) or more
	$1/2H < L \leq H$	11.8 in (299.7 mm) or more
$L > H$	Cannot be installed	

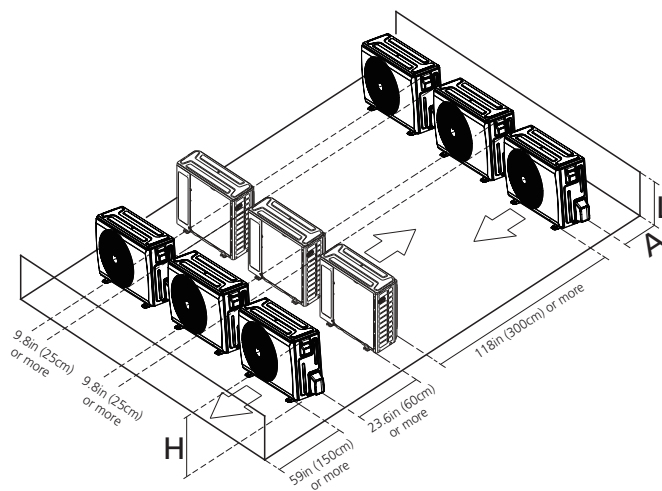

**Note:**

H: Unit height

L: Height of the wall behind the unit

A: Distance between the unit and wall

# Refrigerant Piping Connection

# 6

When connecting the refrigerant piping, do not let substances or gases other than the specified refrigerant from entering the unit. The presence of other gases or substances will lower the unit's capacity, and can cause abnormally high pressure in the refrigeration cycle. This can cause an explosion and injury.

## Notes on Pipe Length & Elevation

### Maximum Length & Drop Height Based on Models

Ensure that the length of the refrigerant pipe, number of bends, and drop height between the indoor and outdoor units meet the requirements shown in the table:

Model	Length of Piping	Maximum Drop Height
36K/48K	246 ft / 75 m	98.4 ft / 30 m

### CAUTION

#### Oil Traps

If oil flows back into the outdoor unit's compressor, this might cause liquid compression or deterioration of oil return. Oil traps in the rising gas piping can prevent this.

Install an oil trap every 20 feet (6 m) of vertical suction line riser (<36K). Install an oil trap every 32.8 feet (10 m) of vertical suction line riser (≥36K).

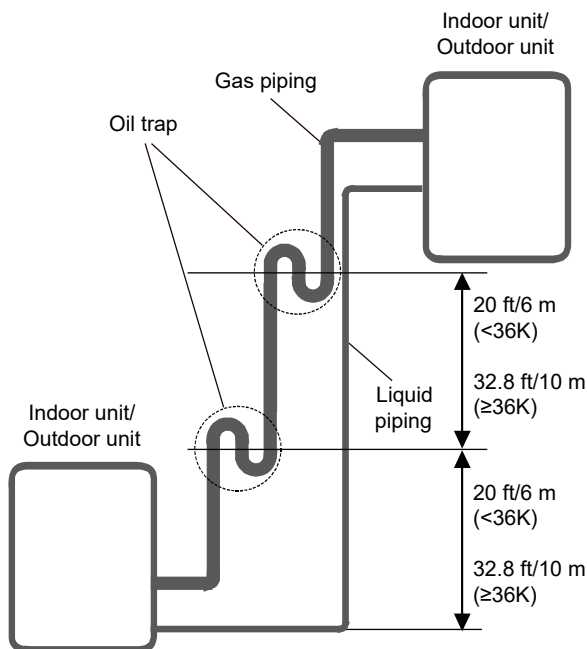

# Refrigerant Piping Connection

# 6

## Connection Instructions - Refrigerant Piping

### ⚠ CAUTION

- Install the branching pipe horizontally. An angle of more than 10° may cause malfunctions.
- Do not install the connecting pipe until both the indoor and outdoor units have been installed.
- Insulate both gas and liquid piping to prevent condensation.

### Step 1: Cut Pipes

When preparing the refrigerant pipes, take extra care to cut and flare them properly. This will ensure efficient operation and minimize the need for future maintenance.

1. Measure the distance between the indoor and outdoor units.
2. Use a pipe cutter to cut the pipe a little longer than the measured distance.
3. Make sure that the pipe is cut at a perfect 90° angle.

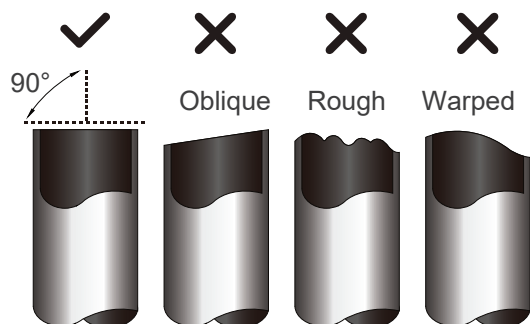

#### ⚠ Do Not Deform the Pipe While Cutting

Be careful not to damage, dent, or deform the pipe while cutting. This will drastically reduce the heating efficiency.

### Step 2: Remove Burrs

Burrs can affect the air-tight seal of the refrigerant piping connection. They must be completely removed.

1. Hold the pipe at a downward angle to prevent burrs from falling into the pipe.
2. Use a reamer or deburring tool to remove all the burrs from the cut section of the pipe.

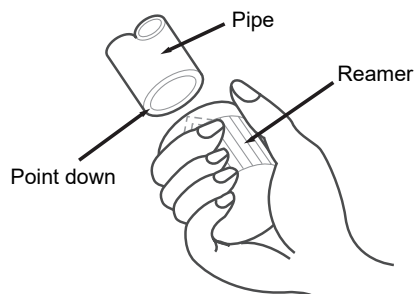

### Step 3: Flare Pipe Ends

Proper flaring is essential to achieve an airtight seal.

1. After removing burrs from the cut pipe, seal the ends with PVC tape to prevent foreign materials from entering the pipe.
2. Sheath the pipe with insulating material.
3. Place flare nuts on both ends of the pipe. Make sure they are facing the correct direction, because it is not possible to change their direction after flaring.

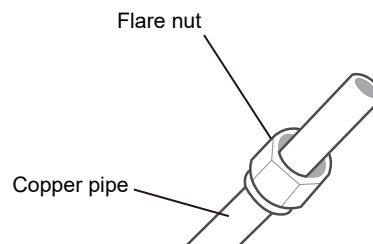

4. Remove the PVC tape from the ends of the pipe when ready to perform the flaring work.

# Refrigerant Piping Connection

# 6

## Step 3: Flare Pipe Ends (Continued)

5. Clamp the flare form on the end of the pipe. The end of the pipe must extend beyond the flare form.

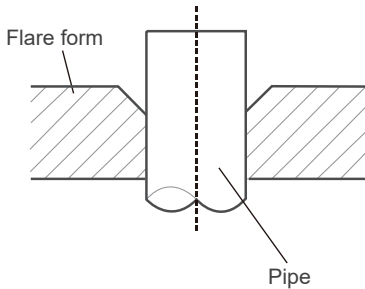

6. Place the flaring tool onto the form.

7. Turn the handle of the flaring tool clockwise until the pipe is fully flared.

Pipe Gauge	Tightening Torque	Flare Dimension (A)	Flare Shape
Ø ¼ in (6.35 mm)	18-20 N.m (180-200 kgf.cm)	0.33~0.34 in (8.4~8.7 mm)	
Ø ⅜ in (9.52 mm)	32-39 N.m (320-390 kgf.cm)	0.52~0.53 in (13.2~13.5 mm)	
Ø ½ in (12.7 mm)	49-59 N.m (490-590 kgf.cm)	0.64~0.65 in (16.2~16.5 mm)	

8. Remove the flaring tool and flare form, then inspect the end of the pipe for cracks and flaring.

## Step 4: Connect Pipes

Connect the copper pipes to the indoor unit first, then connect it to the outdoor unit. Connect the low-pressure pipe, then the high-pressure pipe.

1. When connecting the flare nuts, apply a thin coat of refrigeration oil to the flared ends of the pipes.

2. Align the center of the two pipes intended to be connected.

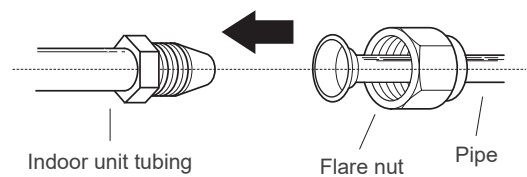

3. Tighten the flare nut snugly by hand.

4. Use a wrench to grip the nut on the unit tubing.

5. While firmly gripping the nut, use a torque wrench to tighten the flare nut according to the torque values in the table.

### Note:

Use both a spanner and torque wrench when connecting or disconnecting pipes to/from the unit.

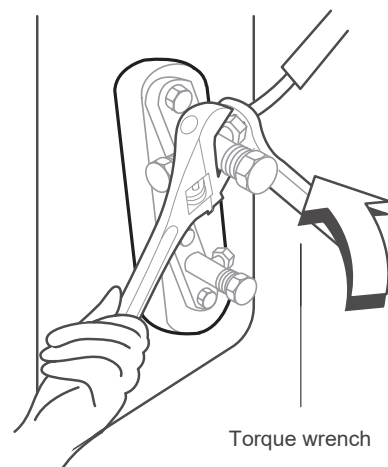

# Refrigerant Piping Connection

# 6

## ⚠ CAUTION

Ensure to wrap the insulation around the piping. Direct contact with the bare piping may result in burns or frostbite.

- Make sure the pipe is properly connected. Over tightening may damage the bell mouth, while under tightening could lead to leakage.

## 💡 Note:

### Minimum Bend Radius

- Carefully bend the tubing in the middle according to the diagram.
- Do not bend the tubing more than 90° or more than three times.

Use appropriate tool

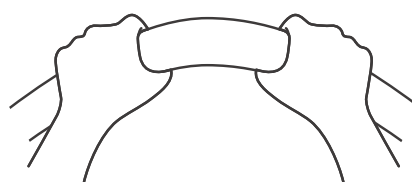

Min-radius 3.9 inch (99 mm)

## Step 4: Connect Pipes (Continued)

6. After connecting the copper pipes to the indoor unit, wrap the power cable, signal cable, and piping together with binding tape.
7. Thread this pipeline through the wall and connect it to the outdoor unit.
8. Insulate all the piping, including the valves of the outdoor unit.
9. Fix the water receiver (supplied in the accessories box) to the indoor unit using a screw.
10. Open the stop valves of the outdoor unit to start the flow of the refrigerant.

## 💡 Note:

- Do not intertwine the signal cable with other wires while bundling these items together.
- Do not intertwine or cross the signal cable with any other wiring.

## ⚠ CAUTION

Check to make sure that there is no refrigerant leakage after completing the installation work. If there is refrigerant leakage, ventilate the area immediately and evacuate the system. Refer to the Air Evacuation section of this manual.

# Wiring Precautions

# 7

## ⚠ WARNING

Before performing any electrical work, read these warnings.

- All wiring must comply with local and national electrical codes and regulations. A licensed electrician must install all the wiring.
- All electrical connections must be made according to the electrical connection diagram located on the panels of the indoor and outdoor units.
- If there is a serious safety issue with the power supply, stop work immediately. Explain the reasoning to the client and refuse to install the unit until the safety issue is properly resolved.
- The power voltage must be within 90-110% of the rated voltage. Insufficient power supply can cause malfunction, electrical shock, or fire.
- Installing an external surge suppressor at the outdoor disconnect is recommended.
- If connecting power to fixed wiring, incorporate a switch or circuit breaker that disconnects all poles and has a contact separation of at least 1/8 of an inch (3 mm). Qualified technicians must use an approved circuit breaker or switch.
- Only connect the unit to an individual branch circuit. Do not connect another appliance to that outlet.
- Make sure to properly ground the air conditioner.
- Firmly connect every wire. Loose wiring can cause the terminal to overheat, resulting in product malfunction and possible fire.
- Do not let wires touch or rest against the refrigerant tubing, compressor, or any moving parts.
- If the unit has an auxiliary electric heater, install it at least 3.3 feet (1 m) away from any combustible materials.
- After turning off the power, always wait 10 minutes or more before touching the electrical components in order to avoid electrical shock.
- Do not cross the electrical wiring with the signal wiring. This may cause distortion, interference, or possibly damage to circuit boards.
- Do not connect other equipment to the same power circuit.
- Connect the outdoor wires before connecting the indoor wires.

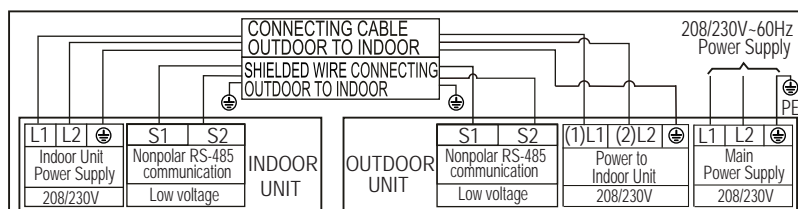

Connection Diagram (36K/48K)

## ⚠ WARNING

Before performing any electrical or wiring work, turn off the main power to the system.

# Wiring Precautions

# 7

## Note for Service Disconnect:

When the maximum current of the air conditioner is more than 16A, use a service disconnect or leakage protection switch with a protective device (purchased separately). When the maximum current of the air conditioner is less than 16A, equip the power cord of the air conditioner with a plug (purchased separately). In North America, wire the appliance according to NEC and CEC requirements.

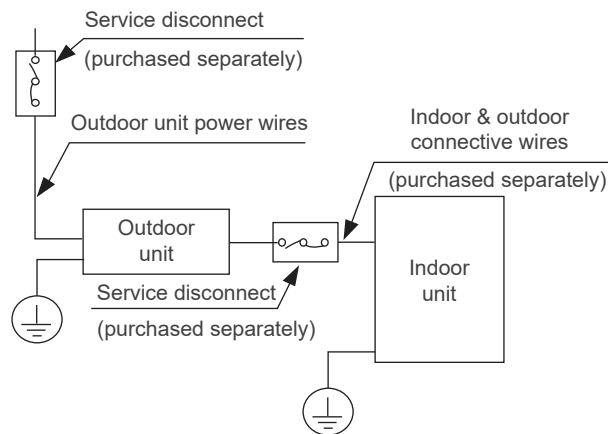

**Note:** The diagrams are for explanation purposes only. The machine may be slightly different. The actual shape shall prevail.

Select the service disconnect as required by local, regional, and national codes.

# Wiring Precautions

# 7

## Outdoor Unit Wiring

### ⚠ WARNING

Before performing any electrical or wiring work, turn off the main power to the system.

#### 1. Prepare the cable for connection:

- a) Begin by choosing the correct cable size. Choose the cable type according to the local electrical codes and regulations.
- b) The minimum circuit ampacity of the unit determines the size of the power supply cable, signal cable, fuse, and switch needed. The minimum circuit ampacity is indicated on the nameplate located on the side panel of the unit. Refer to the nameplate to choose the correct cable, fuse, or switch.
- c) Use wire strippers to strip the rubber jacket from both ends of the signal cable to reveal approximately 5.9 inches (150 mm) of wire.
- d) Strip the insulation from the ends of the cable.
- e) Use a wire crimper to crimp u-lugs on the ends.

**Note:** When connecting the wires, strictly follow the wiring diagram inside the electrical box cover.

2. Remove the electric cover of the outdoor unit. If there is no cover on the outdoor unit, take off the bolts from the maintenance board and remove the protection board.

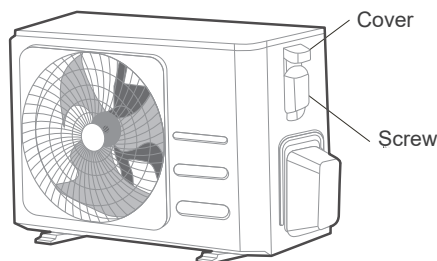

3. Connect the u-lugs to the terminals. Match the wire colors/labels with the labels on the terminal block. Firmly screw the u-lug of each wire to its corresponding terminal.
4. Clamp down the cable with the cable clamp.
5. Insulate unused wires with electrical tape. Keep them away from any electrical or metal parts.
6. Reinstall the cover of the electric control box.

# Wiring Precautions

# 7

## Indoor Unit Wiring

1. Prepare the cable for connection.
  - a. Use wire strippers to strip the rubber jacket from both ends of the signal cable to reveal about 5.9 inches (150 mm) of the wire.
  - b. Strip the insulation from the ends of the wires.
  - c. Use a wire crimper to crimp the u-lugs to the ends of the wires.
2. Open the front panel of the indoor unit. Use a screwdriver to remove the cover of the electric control box for the indoor unit.
3. Thread the power and signal cables through the wire outlet.

Magnetic ring (if supplied and packed with the accessories)

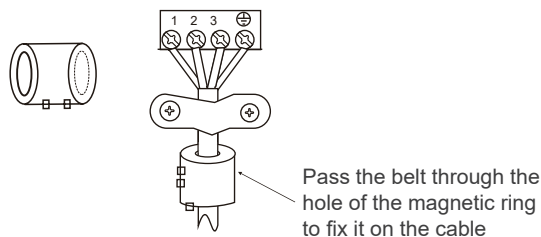

4. Connect the u-lugs to the terminals. Match the wire colors/labels with the labels on the terminal block. Firmly screw the u-lug of each wire to its corresponding terminal. Refer to the serial number and wiring diagram located on the cover of the electric control box.

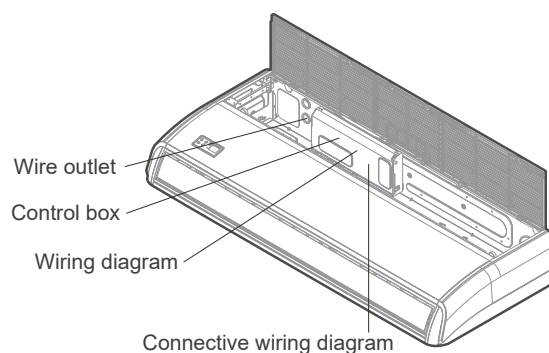

5. Clamp down the cable with the cable clamp. The cable must not be loose or pull on the u-lugs.
6. Reattach the electric box cover.

### ⚠ CAUTION

- While connecting the wires, strictly follow the wiring diagram.
- The refrigerant circuit can become very hot. Keep the interconnection cable away from the copper tube.

# Air Evacuation

# 8

## Note:

When opening the valve stems, turn the hexagonal wrench until it hits against the stopper. Do not try to force the valve to open further.

## Preparations & Precautions

Air and foreign matter in the refrigerant circuit can lead to abnormal rises in pressure, which can damage the air conditioner, reduce its efficiency, and cause injury. Use a vacuum pump and manifold gauge to evacuate the refrigerant circuit, removing any non-condensable gas and moisture from the system. Perform the evacuation after the initial installation and when relocating the unit.

### Before Performing the Evacuation

- ☑ Check to make sure the connective pipes between the indoor and outdoor units are connected properly.
- ☑ Check to make sure all wiring is connected properly.

## Evacuation Instructions

1. Connect the charge hose of the manifold gauge to the service port on the outdoor unit's low-pressure valve.
2. Connect another charge hose from the manifold gauge to the vacuum pump.
3. Open the low-pressure side of the manifold gauge. Keep the high-pressure side closed.
4. Turn on the vacuum pump to evacuate the system.
5. Run the vacuum for at least 15 minutes or until the compound meter reads  $-76\text{cmHg}$  ( $-10^5\text{Pa}$ ).

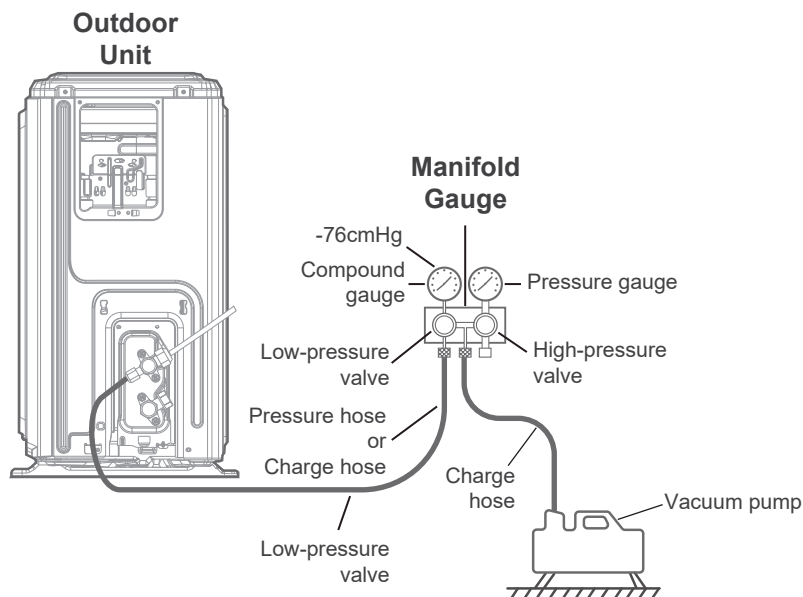

# Air Evacuation

# 8

6. Close the low-side pressure of the manifold gauge, then turn off the vacuum pump.
7. Wait for 5 minutes, then confirm that there has been no change in system pressure.
8. If there is a change in system pressure, refer to the information on how to check for leaks. If there is no change in system pressure, unscrew the cap from the packed valve (high-pressure valve),
9. Insert a hexagonal wrench into the packed valve (high-pressure valve) and open the valve by turning the wrench 1/4 counterclockwise. Listen for gas exiting the system, then close the valve after 5 seconds.
10. Watch the pressure gauge for 1 minute to make sure that there is no change in pressure. The pressure gauge should read slightly higher than the atmospheric pressure.
11. Remove the charge hose from the service port.

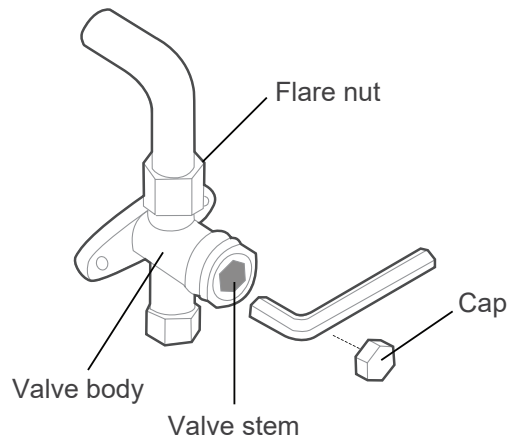

12. Use a hexagonal wrench to fully open both the high-pressure and low-pressure valves.
13. Tighten the caps on all three valves by hand (service port, high pressure, and low pressure). Use a torque wrench to tighten it further.

# Note on Adding Refrigerant

# 9

## CAUTION

Do not mix different types of refrigerant.

Some systems require additional charging depending on the pipe lengths. In North America, the standard pipe length is 25 feet (7.5 m). Charge the refrigerant from the service port on the outdoor unit's low-pressure valve. Calculate the additional refrigerant to be charged using the following formula (the refrigerant quantity added in the following table is a reference value and can be adjusted according to the actual situation):

Refrigerant	Liquid Side Diameter		
	Ø1/4 in (Ø6.35 mm)	Ø3/8 in (Ø9.52 mm)	Ø1/2in (Ø12.7mm)
<b>R-454B</b>	(Pipe length - standard length) x 15g/m (Pipe length - standard length) x 0.16oz/ft	(Pipe length - standard length) x 30g/m (Pipe length - standard length) x 0.32oz/ft	(Pipe length - standard length) x 65g/m (Pipe length - standard length) x 0.69oz/ft

# Test Run

# 10

## CAUTION

Failure to perform the test run may result in unit damage, property damage, or personal injury.

## Before Test Run

Perform the test run after the entire system has been completely installed. Confirm the following points before performing the test:

- a) The indoor and outdoor units are properly installed.
- b) The piping and wiring are properly connected.
- c) There are no obstacles near the inlet and outlet of the unit that might cause poor performance or product malfunction.
- d) The refrigeration system does not leak.
- e) The drainage system is unimpeded and draining to a safe location.
- f) The heating insulation is properly installed.
- g) The grounding wires are properly connected.
- h) The length of the piping and additional refrigerant capacity have been recorded.
- i) The power voltage is the correct voltage for the air conditioner.

# Test Run

# 10

## Test Run Instructions

1. Open both the liquid and gas stop valves.
2. Turn on the main power switch and allow the unit to warm up.
3. Set the air conditioner to Cooling mode.
4. For the indoor unit:
  - a) Ensure that the remote control and its buttons operate properly.
  - b) Ensure that the louvers move properly and can be changed using the remote control.
  - c) Double check to see if the room temperature is being registered correctly.
  - d) Ensure that the indicators on the remote control and display panel for the indoor unit operate properly.
  - e) Ensure that the manual buttons on the indoor unit operate properly.
  - f) Confirm that the drainage system is unimpeded and draining smoothly.
  - g) Ensure that there is no vibration or abnormal noise during operation.
5. For the outdoor unit:
  - a) Check to see if the refrigeration system is leaking.
  - b) Make sure there is no vibration or abnormal noise during operation.
  - c) Ensure that the wind, noise, and water generated by the unit does not disturb neighbors or pose a safety hazard.
6. Drainage Test
  - a) Ensure that the drainpipe flows smoothly. New buildings should perform this test before finishing the ceiling.
  - b) Remove the test cover. Add 67.6 oz (2,000 ml) of water to the tank through the attached tube.
  - c) Turn on the main power switch and run the air conditioner in Cooling mode.
  - d) Listen to the sound of the drain pump to check if it makes any unusual noises.
  - e) Confirm the water is discharged. It may take up to 1 minute before the unit begins to drain, depending on the drainpipe.
  - f) Make sure that there are no leaks in any of the piping.
  - g) Stop the air conditioner. Turn off the main power switch and reinstall the test cover.

**Note:** If the unit malfunctions or does not operate according to expectations, refer to the Troubleshooting section in this manual before calling customer service.

# Unpacking & Packing

# 11

**Instructions for unpacking and packing the unit:**

## Unpacking:

### Indoor Unit:

1. Cut the packing belt.
2. Unpack the package.
3. Take out the packing cushion and support.
4. Remove the packing film.
5. Take out the accessories.
6. Lift the machine out and lay it flat.

### Outdoor Unit:

1. Cut the packing belt.
2. Take the unit out of the package.
3. Remove the foam from the unit.
4. Remove the packing film from the unit.

## Packing:

### Indoor Unit:

1. Put the indoor unit into the packing film.
2. Put the accessories in.
3. Place the packing cushion and support.
4. Put the indoor unit into the package.
5. Close the package and seal it.
6. Use the packing belt if necessary.

### Outdoor Unit:

1. Put the outdoor unit into the packing film.
2. Put the bottom foam into the box.
3. Put the outdoor unit into the package, then put the upper packaging foam on the unit.
4. Close the package and seal it.
5. Use the packing belt if necessary.

**Note:** Keep all the packaging items in case they're needed in the future.

# Operation Instructions

# 12

**Note:**

- Different models have different front panels and display windows. The indicators described below may not be available for your air conditioner.
- Illustrations in this manual are for explanatory purposes. The actual shape of the indoor unit may differ slightly. The actual shape shall prevail.



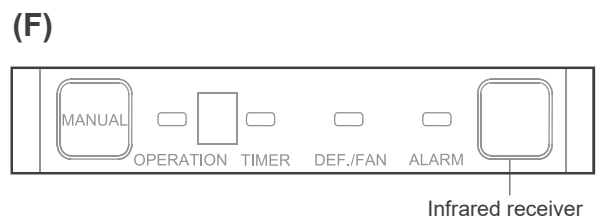
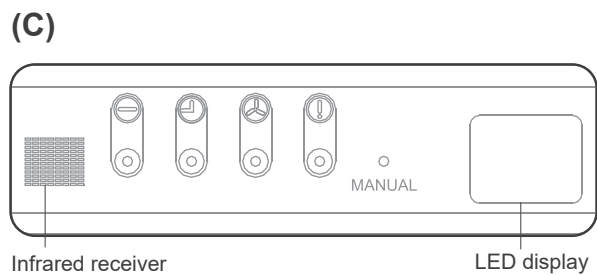
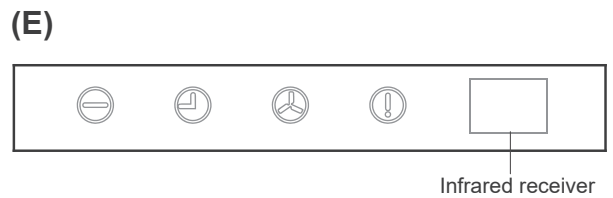
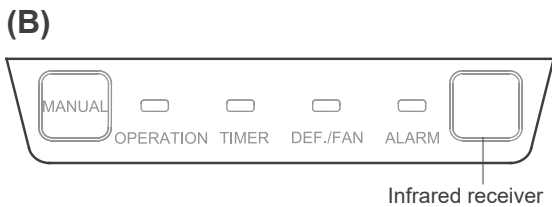
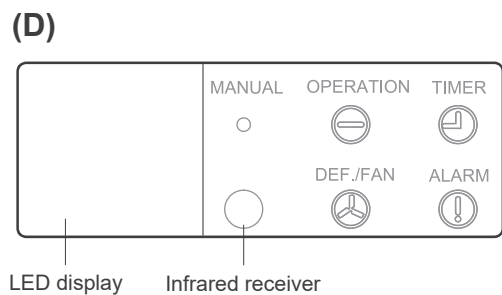
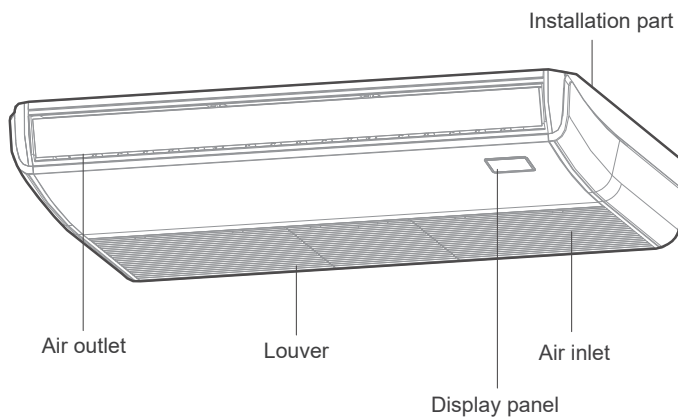

## Indoor Unit Display



# 12

## Operation Instructions

- Manual Button: This button select the mode in the following order: Auto, Forced Cool, and Off.
  - Forced Cool Mode: In this mode, the operation light flashes. The system will turn to Auto mode after it has cooled with a high wind speed for 30 minutes. The remote control will be disabled during this operation.
  - Off Mode: The unit turns off.

- Operation Indicator: 
- Timer Indicator: 
- Pre-Def Indicator: (Pre-heating/Defrost) 
- Alarm Indicator: 
- 
- Func Button: 

**Note:**

Each time the air conditioner is powered on, a buzzing sound will be heard to indicate that the product has been powered on normally. If there is no sound, it is possible that the unit is operating abnormally. Power on the unit again or check the circuit.

The actual functions are subject to the product that was purchased. Check the indoor display and remote control of the air conditioner. See the Remote Controller manual for information on more features.

### Heat Exchanger Dust Removal Function

This feature helps keep the outdoor coil cleaner and may extend the duration between regular maintenance intervals, depending on local conditions. When the unit is turned off, a 10-second delay occurs. Then, the outdoor fan runs in reverse rotation for 70 seconds to blow off loose accumulated dust and debris.

### Refrigerant Leakage Detection

When the system detects a refrigerant malfunction, the indoor unit will automatically display the following error codes:

- EL0C - System lacks refrigerant.
- EHC1 - Refrigerant sensor detects leakage.
- EHC2 - Working condition of the refrigerant sensor is out of range and leakage is detected.
- EHC3 - Working condition of the refrigerant sensor is out of range.
- ECC1 - Other indoor unit refrigerant sensor detects leakage (multi-zone).

When EHC1 or EHC2 errors occur, the buzzer will continue to beep for 5-6 minutes before stopping. Pressing any button the remote controller will stop the buzzer.



# Care & Maintenance

# 13

## ⚠ CAUTION

- The cooling efficiency of the unit and your health could be damaged by the clogged AC. Make sure to clean the filter every two weeks.
- Always turn off the system and disconnect its power supply before cleaning or performing maintenance.
- Only use a soft, dry cloth to wipe the unit clean. If the unit is especially dirty, use a cloth soaked in warm water to wipe it clean.
- Do not use chemicals or chemically treated cloths to clean the unit.
- Do not use paint thinner, polishing powder, or other solvents to clean the unit. They can cause the plastic surface to crack or deform.
- Do not use water hotter than 104°F (40°C) to clean the front panel. This can cause the panel to deform or become discolored.

## Clean the Indoor Unit (Air Filter)

### Step 1:

Open the air intake with a screwdriver or similar tool. Detach the grille from the main unit by holding the grille at a 45° angle, lifting it up slightly, and then pulling the grille forward.

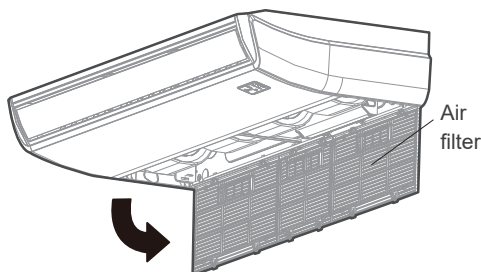

### Step 2:

Take out the air filter. (Applicable to 3.2-10.5KW air conditioners only).

Directly pull out the air filter from the air inlet as indicated. (Applicable to 14-16KW air conditioners only).

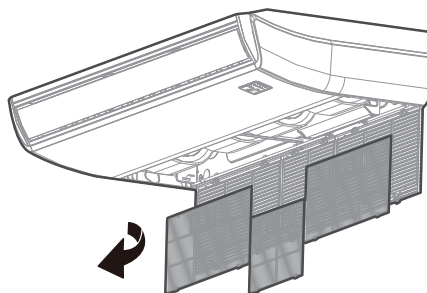

# Care & Maintenance

# 13

## Step 3:

Remove the air filter. Clean the air filter by vacuuming the surface or washing it in warm water with mild detergent.

## Step 4:

Rinse the filter with clean water and allow it to air-dry. Do not let the filter dry in direct sunlight. Reinstall the filter.

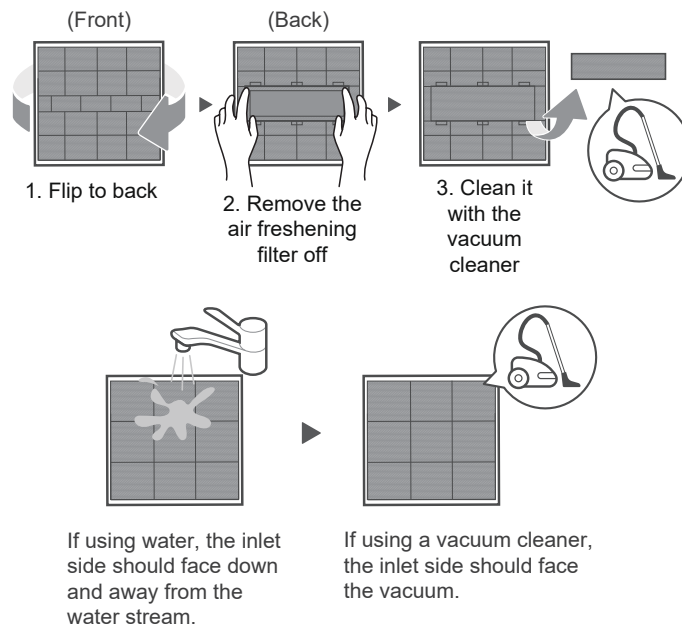

## ⚠ CAUTION

- Before changing the filter or cleaning the system, turn off the unit and disconnect its power supply.
- When removing the filter, do not touch metal parts in the unit. The sharp metal edges can cut you.
- Do not use water to clean the inside of the indoor unit. This can destroy the insulation and cause electrical shock.
- Do not expose the filter to direct sunlight when drying. This can shrink the filter.
- An authorized dealer or licensed service provider must maintain and clean the outdoor unit.
- An authorized dealer or licensed service provider must perform any unit repairs.

# Care & Maintenance

# 13

## Maintain the AC

### Maintenance – Long Periods of Non-Use

If the air conditioner won't be used for an extended period of time.



Clean all filters



Turn on FAN function until the unit dries out completely



Turn off the unit and disconnect the power

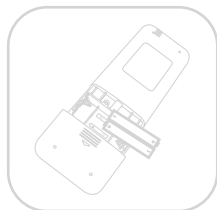

Remove batteries from the remote control

### Maintenance – Pre-Season Inspection

After long periods of non-use, or before periods of frequent use, do the following:

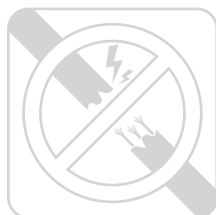

Check for damaged wires

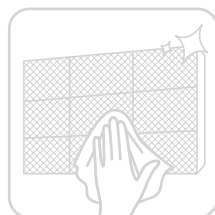

Clean all filters



Check for leaks



Make sure nothing is blocking the air inlets and outlets

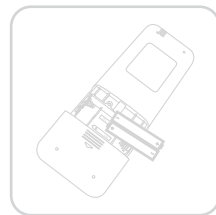

Replace batteries

# Troubleshooting

## T

### ⚠ CAUTION

If any of the following conditions occur, turn off the unit immediately:

- The power cord is damaged or abnormally warm.
- A burning odor is present.
- The unit is emitting loud or abnormal sounds.
- A power fuse blows or the circuit breaker frequently trips.
- Water or other objects fall into or out of the unit.

**Do not attempt to fix these problems by yourself. Contact an authorized service provider immediately.**

## Common Issues

The following issues are not malfunctions and will not require repairs in most situations:

Issue	Possible Causes
Unit does not turn on when pressing the On/Off button	The unit has a 3-minute protection feature that prevents the unit from overloading. The unit cannot be restarted within 3 minutes of being turned off.
	Cooling and Heating mode: If the operation light and PRE-DEF (pre-heating/defrost) indicators are lit up, the outdoor temperature is too cold, activating the unit's anti-cold wind feature in order to defrost the unit.
	In Cooling-only mode: If the Fan-Only indicator is lit up, the outdoor temperature is too cold, activating the unit's anti-freeze protection in order to defrost the unit.
Unit changes from Cooling/Heating mode to Fan mode	The unit may change its settings to prevent frost from forming on the unit. Once the temperature increases, the unit will start operating in the previously selected mode again.
	The set temperature has been reached, at which point the unit turns off the compressor. The unit will continue operating when the temperature fluctuates again.
Indoor unit emits white mist	In humid regions, a large temperature difference between the room's air and the conditioned air can cause white mist.
Indoor and outdoor units emit white mist	When the unit restarts in Heating mode after defrosting, white mist may be emitted due to moisture generated from the defrosting process.
Indoor unit makes noises	A rushing air sound may occur when the louver resets its position.
	A squeaking sound is heard when the system is off or in Cooling mode. The noise is also heard when the drain pump (optional) is in operation.
	A squeaking sound may occur after running the unit in Heating mode, due to expansion and contraction of the unit's plastic parts.
Indoor and outdoor units make noises	Low hissing sound during operation: This is normal and caused by refrigerant gas flowing through both the indoor and outdoor units.
	Low hissing sound when the system starts, stops running, or defrosting: This noise is normal and caused by the refrigerant gas stopping or changing direction.
	Squeaking sound: Normal expansion and contraction of plastic and metal parts caused by temperature changes during operation can cause squeaking noises.

# Troubleshooting

# T

Issue	Possible Causes
Outdoor unit makes noises	The outdoor unit will make different sounds based on its current operating mode.
Dust is emitting from either the indoor or outdoor unit	The unit may accumulate dust during extended periods of non-use, which will be emitted when the unit is turned on. This can be mitigated by covering the unit during long periods of inactivity.
Unit emitting bad odor	The unit may absorb odors from the environment, which will be emitted during operations. Examples are furniture, cooking, cigarettes, etc.
	The unit's filters have become moldy and need to be cleaned.
Fan of the outdoor unit does not operate	During operation, the fan speed is controlled to optimize product operation.

**Note:** If the problem persists, contact a local dealer or the nearest customer service center. Provide them with a detailed description of the unit malfunction and model number.

**When trouble occurs, check the following points before contacting a repair company:**

Problem	Possible Causes	Solution
Poor Cooling Performance	The temperature setting may be higher than the ambient room temperature.	Lower the temperature setting.
	Heat exchanger on the indoor or outdoor unit is dirty.	Clean the affected heat exchanger.
	Air filter is dirty.	Remove the filter and clean it according to the instructions in this manual.
	Air inlet or outlet of either unit is blocked.	Turn the unit off, remove the obstruction, and turn it back on.
	Doors and windows are open.	Make sure that all doors and windows are closed while operating the unit.
	Excessive heat is generated by sunlight.	Close windows and curtains during periods of high heat or bright sunshine.
	Too many sources of heat in the room (people, computers, electronics, etc.).	Reduce the amount of heat sources.
	Low refrigerant due to leak or long-term use.	Check for leaks. Reseal if necessary and top off the refrigerant.

# Troubleshooting

# T

Problem	Possible Causes	Solution
Unit is not working	Power failure.	Wait for the power to be restored.
	Power is turned off.	Turn on the power.
	Fuse is burned out.	Replace the fuse.
	Remote control batteries are dead.	Replace the batteries.
	The unit's 3-minute protection has been activated.	Wait 3 minutes after restarting the unit.
	The unit's timer is activated.	Turn the timer off.
Unit starts and stops frequently	There's too much or little refrigerant in the system.	Check for leaks and recharge the system with refrigerant.
	Incompressible gas or moisture has entered the system.	Evacuate and recharge the system with refrigerant.
	System circuit is blocked.	Determine which circuit is blocked and replace the malfunctioning piece of equipment.
	Compressor is broken.	Replace the compressor.
	Voltage is too high or low.	Install a manostat to regulate the voltage.
Poor heating performance	Outdoor temperature is extremely low.	Use an auxiliary heating device.
	Cold air is entering through doors and windows.	Make sure that all doors and windows are closed during use.
	Low refrigerant due to leak or long-term use.	Check for leaks. Reseal if necessary and top off refrigerant.

Indicator lamps continue to flash

Error codes appear and begin with the letters as the following in the window display of the indoor unit:

- E (x), P (x), F (x)
- EH (xx), EL (xx), EC (xx)
- PH (xx), PL (xx), PC (xx)

The unit may stop operation or continue to run safely. If the indicator lamps continue to flash or error codes appear, wait about 10 minutes. The problem may resolve itself.

If not, disconnect the power. Then, connect the power again and turn the unit on.

**Note:** If the problem continues after performing the checks and diagnostics above, turn off the unit immediately and contact an authorized service center.

The design and specifications are subject to change without prior notice for product improvements. Consult with the sales agency or manufacturer for details. Any updates to the manual will be uploaded to the service website, check for the latest version.

The design and specifications of this product are subject to change without prior notice as development continues. Consult with the sales agency or manufacturer for details. Refer to the equipment nameplate for all other applicable specifications.



is a registered trademark of Parker Davis HVAC International, LLC.

Parker Davis HVAC International  
7290 NW 77 Court, Miami, FL 33166 - USA  
Tel : (305) 513-4488  
Fax : (305) 513-4499  
E-mail : info@pdhvac.com  
Website: www.pdhvac.com

Pioneer product line, parts, and supplies are available online for convenient ordering at:  
[www.highseer.com](http://www.highseer.com)  
[www.pioneerminisplit.com](http://www.pioneerminisplit.com)

Scan the below code to visit our support page where you can find more installation materials:



Copyright © Parker Davis HVAC International, LLC. All rights reserved.

---