

READ AND SAVE THESE INSTRUCTIONS

AURA



OPERATION, MAINTENANCE
AND SAFETY INSTRUCTIONS

OP125

omega
altise

Due to ongoing product development, images shown are subject to change without warning

TABLE OF CONTENTS

Important Safety Instructions 1

Product Overview 2

GENERAL SPECIFICATION 2.1

DETAILED SPECIFICATION 2.2

Parts & Assembly 3-4

CARTON CONTENTS 3.1

ASSEMBLY INSTRUCTIONS 3.2 - 4.1

Useful Information 5

CLEANING 5.1

OSCILLATION 5.2

REMOTE STORAGE 5.3

Important Safety Instructions

IMPORTANT

Read the safety precautions of this booklet carefully before attempting to assemble, install, operate or maintain the product described. Protect yourself and others by observing all safety information. Failure to comply with instructions could result in personal injury and/or property damage. If you are unsure about anything regarding your fan or these instructions, please contact Omega Altise on 1300 795 572 in Australia or (09) 415 6000 in New Zealand before operating your appliance.

1. Read all instructions carefully before using the pedestal fan.
2. Use this pedestal fan only as described in this manual. Any other use not recommended by the manufacturer may cause fire, electrical shock, or injury to persons. Do not modify this appliance. Do not try to repair this appliance – there are no user serviceable parts within.
3. Remove the packaging and ensure that the appliance is undamaged (keep packing box for later storage). In case of doubt do not use the appliance and contact Omega Altise Service. Do not let children play with any parts of the packaging.
4. Before you use the appliance, check if the voltage marked on the rating label corresponds to the mains in your home.
5. Do not use this appliance with a programmer, timer or any other device that switches the appliance on automatically, since a fire risk exists if the appliance is covered or positioned incorrectly.
6. Do not pull the power cord to disconnect with the power source. Always grasp the plug to pull it out.
7. Do not run power cords under rugs, curtains or other combustible materials. Do not place power cords in areas where they can be a tripping hazard. Do not operate directly below a power outlet.
8. Do not insert any objects into the appliance as it may cause an electric shock or fire or damage to the appliance. Do not block or tamper with the appliance in any manner while it is in operation. To prevent a possible fire, do not cover the appliance in any manner. Do not place on soft surfaces, like a bed, where openings may become blocked.
9. Do not leave the appliance unattended. Always unplug the appliance when not in use. Take care that it is not obstructed when oscillating.
10. The appliance is only to be used with the power supply unit provided with the appliance.
11. This appliance can be used by children aged from 8 years and above and persons with reduced physical, sensory or mental capabilities or lack of experience and knowledge if they have been given supervision or instruction concerning use of the appliance in a safe way and understand the hazards involved. Children shall not play with the appliance. Cleaning and user maintenance shall not be made by children without supervision.



WARNING:

The Function Switch should not be used as the sole means of disconnecting power. Always unplug the power cord before servicing or moving the appliance.

1. Keep materials such as hair, net curtains, tablecloths & clothes away from the openings of the pedestal fan, as material may be sucked into the appliance causing injury or damage to property or the appliance.
2. The appliance has hot and arcing or sparking parts inside. It must NOT be used in potentially dangerous locations such as flammable, explosive, chemical-laden, corrosive, salty or wet atmospheres. This appliance is intended for general indoor domestic use ONLY.
3. This appliance is not intended for use in wet or damp locations. Never locate it where it may fall into a bathtub or other water container.
4. Do not use the pedestal fan outdoors. Do not use close to windows or in direct sunlight.
5. Always place the appliance on flat, stable surfaces before use. Always place the appliance vertically on its base.

NOTE: Over time, the grills at the front and rear of the appliance will build up dust & dirt. This should be cleaned regularly to maintain optimum efficiency. Follow the cleaning procedure within this instruction



WARNING:

To avoid danger of electric shock, unplug from outlet when not in use and before cleaning. If the supply cord is damaged, it must be replaced by the manufacturer, its Service Agent or similarly qualified persons in order to avoid a hazard. In order to avoid overheating, do not cover the appliance. Do not use the appliance in the immediate surrounding of a bath, shower or swimming pool

2.1 GENERAL SPECIFICATION







MODEL:	OP125B - Blue
	OP125BLK - Black
	OP125M - Mint
	OP125W - White
Rated Voltage:	24VDC
Rate Power Input:	30w
Product Dimensions - Base (mm):	1255h x 700w x 700d
Product Dimensions - Head (mm):	1255h x 325w x 215d
Weight:	5kg

2.2 DETAILED SPECIFICATION

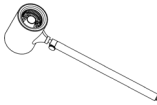
Setting Position (Speed)	5-6 High Range	3-4 Mid Range	1-2 Low Range
dB(A)	71.1	64.7	61.1
Meters per second	5.8	4.5	3.9
Max fan flow rate	16.83	13.01	11.39
Tested according to clause 9 of IEC60879:1986 (corr.1992) at client specified setting positions			

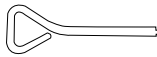
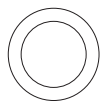

3.1 CARTON CONTENTS

1) Fan Assembly x 1pc 	2) Base x 1pc 	3) Screw M4*30 x 3pcs 	4) AC/DC Adapter x 1pc 
5) Remote Control x 1pc 	6) Remote Control Bracket x 1pc 	7) Screw Driver x 1pc 	8) CR2032 Battery 

3.2 ASSEMBLY INSTRUCTIONS

STEP 1: ATTACH BASE TO STAND

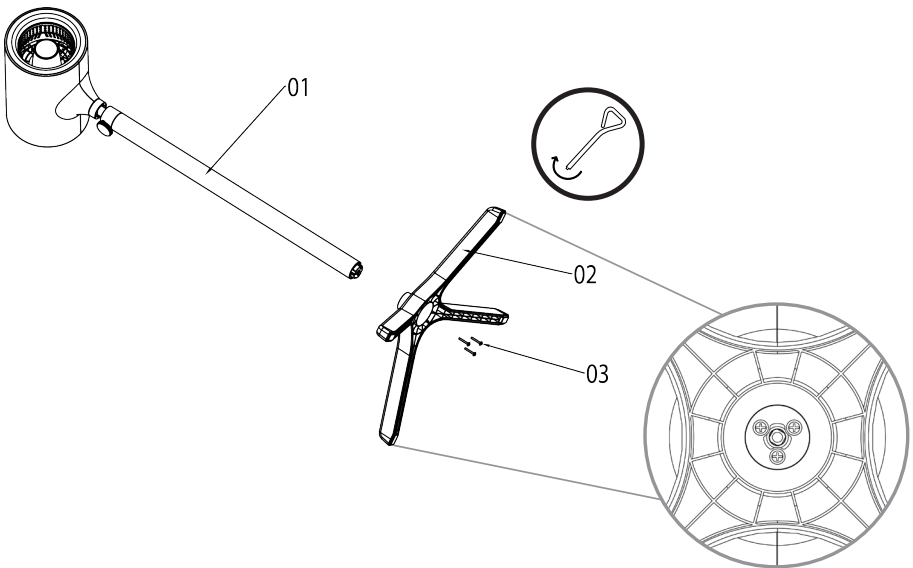

4.1 ASSEMBLY INSTRUCTIONS CONT.

STEP 2: INSERT AC/DC ADAPTER

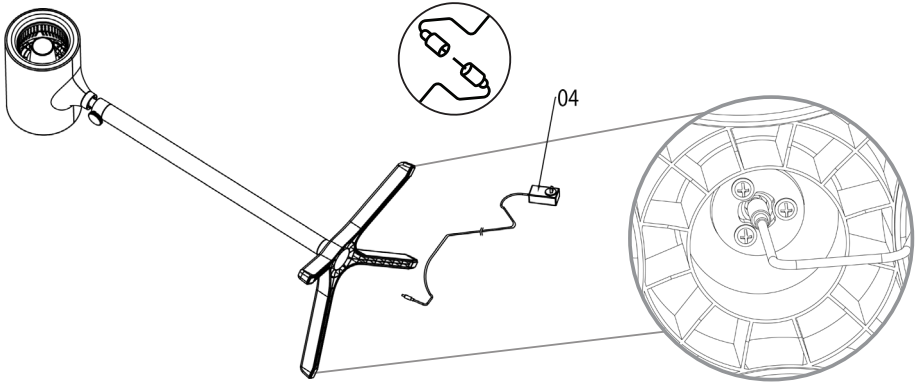

STEP 3: SYNC REMOTE TO FAN



1. Turn on the fan
2. Remove protective film strip from remote to activate battery
 - If no battery, please insert a new one (CR2032)
3. Press and hold the power button and oscillation buttons for 5 seconds
 - Remote will now sync, if unsuccessful, repeat this step

5.1 CLEANING

Cleaning should be performed periodically to ensure the longevity of your new fan.

- Ensure the fan is disconnected from the power
- Take a clean microfiber cloth
- Wipe rear and front guard until clean

WARNING: Cleaning should never be performed while the fan is in use.

5.2 OSCILLATION

Oscillation can be set by the remote control, refer to step 3 for operation instructions. There are two forms of oscillation associated with the AURA:

- Left/right - maximum range is $80^\circ \pm 2^\circ$
- Up/down - maximum range is $40^\circ \pm 2^\circ$ (Manual Configuration only)

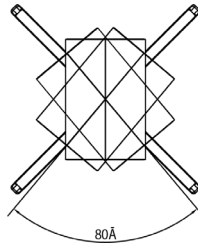
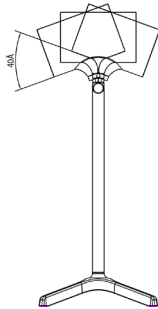

5.3 REMOTE STORAGE

- Remote can be stored in the rear guard when the fan is off for discrete storage.
- When fan is operating, remote can be stored in holder. Holder can be attached to the stand pole.

WARNING: Do not store remote control in the rear guard whilst the fan is in use.

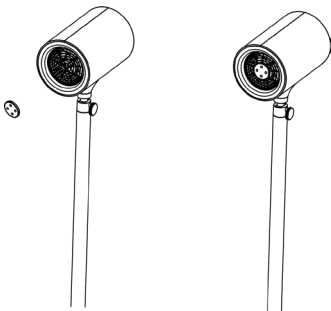

Rear Guard Storage

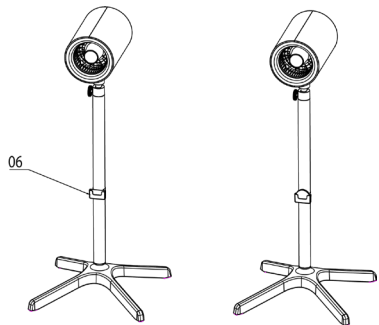

Remote Holder (while fan is in use)

omega altise

It is important that you retain these instructions, proof of purchase as well as other important documents about this product for future reference. Due to continual product development, Omega Altise reserves the right to alter specifications or appearances without notice.

Dispose of packaging responsibly - recycle where facilities are available.

A division of Shiro Australia Pty Ltd
104 Vanessa St Kingsgrove NSW 2208
In Australia: 1300 795 572
In New Zealand: (09) 415 6000

www.omegaltise.com.au