

BOSE

QUIETCOMFORT EARBUDS

Please read and keep all safety and use instructions.



Bose Corporation hereby declares that this product is in compliance with the essential requirements and other relevant provisions of Directive 2014/53/EU and all other applicable EU directive requirements. The complete declaration of conformity can be found at: www.Bose.com/compliance



This product conforms to all applicable Electromagnetic Compatibility Regulations 2016 and all other applicable UK regulations. The complete declaration of conformity can be found at: www.Bose.com/compliance

Bose Corporation hereby declares that this product is in compliance with the essential requirements per Radio Equipment Regulations 2017 and all other applicable UK regulations. The complete declaration of conformity can be found at: www.Bose.com/compliance

Important Safety Instructions

Clean only with a dry cloth.

Only use attachments/accessories specified by the manufacturer.

Refer all servicing to qualified personnel. Servicing is required when the apparatus has been damaged in any way, such as power-supply cord or plug is damaged, liquid has been spilled or objects have fallen into the apparatus, the apparatus has been exposed to rain or moisture, does not operate normally, or has been dropped.



WARNINGS/CAUTIONS

- To avoid accidental ingestion, keep the product away from children and pets. The product contains a battery, and may be hazardous if swallowed. If ingested, seek immediate medical attention. When not in use, store the product out of reach of children and pets.
- Product is not intended for use by children.
- To avoid hearing damage, do not use your headphones at a high volume. Turn the volume down on your product before placing the headphones in/on your ears, then turn the volume up gradually until you reach a comfortable, moderate listening level.
- Use of these headphones while operating a vehicle is not recommended and may be prohibited by law in some locations. Use caution and follow applicable laws regarding headphone use while operating a vehicle. Stop using your headphones immediately if they interfere with your ability to remain attentive or if they interfere with your ability to hear surrounding sounds, including alarms and warning signals, while operating a vehicle.
- Use caution if using these headphones while performing any activity that requires your attention. Do not use the headphones when the inability to clearly hear surrounding sounds may present a danger to yourself or others, for example while riding a bicycle or walking in or near traffic, a construction site, railroad, etc.
- Do NOT use the earbuds if they emit any loud unusual noise. If this happens, remove the earbuds and contact Bose customer service.
- Do NOT submerge the product in water or expose the product to water for extended periods.
- Remove product immediately if you notice heat coming from the product.

⚠ WARNING	
<ul style="list-style-type: none"> • INGESTION HAZARD: This product contains a button cell or coin battery. • DEATH or serious injury can occur if ingested. • A swallowed button cell or coin battery can cause Internal Chemical Burns in as little as 2 hours. • KEEP new and used batteries OUT OF REACH OF CHILDREN • Seek immediate medical attention if a battery is suspected to be swallowed or inserted inside any part of the body. 	

- Remove and immediately recycle or dispose of used batteries according to local regulations and keep away from children. Do NOT dispose of batteries in household trash or incinerate.
- Even used batteries may cause severe injury or death.
- Call a local poison control center for treatment information.
- Do not force discharge, recharge, disassemble, heat above 185°F (85°C) or incinerate. Doing so may result in injury due to venting, leakage or explosion resulting in chemical burns.
- Non-rechargeable batteries are not to be recharged.
- This product contains non-replaceable batteries.
- Battery Type: 1254PF4F or M1254A6 | Nominal Battery Voltage: 3.85VDC



Contains small parts which may be a choking hazard. Not suitable for children under age 3.



This product contains magnetic material. Consult your physician on whether this might affect your implantable medical device.

- Do NOT make unauthorized alterations to this product.
- Keep the product away from fire and heat sources. Do NOT place naked flame sources, such as lighted candles, on or near the product.
- Do NOT use the earbuds without the supplied eartips attached.
- Use this product only with an agency-approved LPS power supply that meets local regulatory requirements (e.g., UL, CSA, VDE, CCC).
- The battery provided with this product may present a risk of fire, explosion or chemical burn if mishandled, incorrectly replaced or replaced with an incorrect type.
- Do not expose products containing batteries to excessive heat (e.g. from storage in direct sunlight, fire or the like).
- Wipe off sweat from the earbuds and the charging case before charging.
- IPX4 is not a permanent condition, and resistance might decrease as a result of normal wear.
- To avoid hazardous radiation exposure from the internal laser component, use the product only as specified in the instructions. The earbuds should not be adjusted or repaired by anyone except properly qualified service personnel.
- Do not place or install near any heat sources, such as fireplaces, radiators, heat registers, stoves or other apparatus (including amplifiers) that produce heat.
- Complies with 21 CFR 1040.10 and 1040.11 except for conformance with IEC 60825-1 Ed. 3 as described in Laser Notice 56, date May 8, 2019.



This product is classified as a CLASS 1 CONSUMER LASER PRODUCT according to EN 50689:2021 and IEC 60825-1:2014.

NOTE: This equipment has been tested and found to comply with the limits for a Class B digital device, pursuant to Part 15 of the FCC Rules. These limits are designed to provide reasonable protection against harmful interference in a residential installation. This equipment generates, uses, and can radiate radio frequency energy and, if not installed and used in accordance with the instructions, may cause harmful interference to radio communications. However, there is no guarantee that interference will not occur in a particular installation. If this equipment does cause harmful interference to radio or television reception, which can be determined by turning the equipment off and on, the user is encouraged to try to correct the interference by one or more of the following measures:

- Reorient or relocate the receiving product or antenna.
- Increase the separation between the equipment and receiver.
- Connect the equipment into an outlet on a circuit different from that to which the receiver is connected.
- Consult the dealer or an experienced radio/TV technician for help.

Changes or modifications not expressly approved by Bose Corporation could void the user's authority to operate this equipment.

This device complies with part 15 of the FCC Rules and with ISED Canada license-exempt RSS standard(s). Operation is subject to the following two conditions: (1) This device may not cause harmful interference, and (2) this device must accept any interference received, including interference that may cause undesired operation.

This device complies with FCC and ISED Canada radiation exposure limits set forth for general population. This transmitter must not be co-located or operating in conjunction with any other antenna or transmitter.

FCC ID: A94318 | **IC:** 3232A-318 | **Case Model:** 442318 | **Right Earbud Model:** 318R | **Left Earbud Model:** 318L



020-240145

CAN ICES-3(B)/NMB-3(B)

For Europe: Frequency band of operation 2400 to 2483.5 MHz. | Maximum transmit power less than 20 dBm EIRP. | Frequency band of operation: 111 kHz - 148 kHz. | Maximum transmit power less than 37.7 dBuA/m.

EU SAR Information

Earbud	Measured 1-g SAR W/kg	Measured 10-g SAR W/kg
Left	0.970	0.190
Right	0.590	0.150

The Korean Electromagnetic Absorption Grade Mark can be found at: www.Bose.com/compliance



This symbol means the product must not be discarded as household waste, and should be delivered to an appropriate collection facility for recycling. Proper disposal and recycling helps protect natural resources, human health and the environment. For more information on disposal and recycling of this product, contact your local municipality, disposal service, or the shop where you bought this product.

Low-power Radio-frequency Devices Technical Regulations

Without permission granted by the NCC, any company, enterprise, or user is not allowed to change frequency, enhance transmitting power or alter original characteristic as well as performance to an approved low power radio-frequency devices. The low power radio-frequency devices shall not influence aircraft security and interfere legal communications; If found, the user shall cease operating immediately until no interference is achieved. The said legal communications means radio communications is operated in compliance with the Telecommunications Management Act. The low power radio-frequency devices must be susceptible with the interference from legal communications or ISM radio wave radiated devices.

DON'T attempt to remove the rechargeable lithium-ion battery from this product. Contact your local Bose retailer or other qualified professional for removal.



Please dispose of used batteries properly, following local regulations. Do not incinerate.

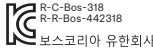

Names and Contents of Toxic or Hazardous Substances or Elements						
Part Name	Toxic or Hazardous Substances and Elements					
	Lead (Pb)	Mercury (Hg)	Cadmium (Cd)	Hexavalent (CR(VI))	Polybrominated Biphenyl (PBB)	Polybrominated diphenylether (PBDE)
PCBs	X	O	O	O	O	O
Metal Parts	X	O	O	O	O	O
Plastic Parts	O	O	O	O	O	O
Speakers	X	O	O	O	O	O
Cables	X	O	O	O	O	O

This table is prepared in accordance with the provisions of SJ/T 11364.

O: Indicates that this toxic or hazardous substance contained in all of the homogeneous materials for this part is below the limit requirement of GB/T 26572.

X: Indicates that this toxic or hazardous substance contained in at least one of the homogeneous materials used for this part is above the limit requirement of GB/T 26572.



Equipment name: Earbuds and Charging Case Type designation: 442318						
Unit	Restricted substances and its chemical symbols					
	Lead (Pb)	Mercury (Hg)	Cadmium (Cd)	Hexavalent chromium (Cr ⁺⁶)	Polybrominated biphenyls (PBB)	Polybrominated diphenyl ethers (PBDE)
PCBs	-	o	o	o	o	o
Metal Parts	-	o	o	o	o	o
Plastic Parts	o	o	o	o	o	o
Speakers	-	o	o	o	o	o
Cables	-	o	o	o	o	o

Note 1: "o" indicates that the percentage content of the restricted substance does not exceed the percentage of reference value of presence.

Note 2: The "-" indicates that the restricted substance corresponds to the exemption.



Date of Manufacture: The eighth digit in the serial number indicates the year of manufacture; "4" is 2014 or 2024. | **Location of Manufacture:** The seventh digit in the serial number indicates the location of manufacture.

Importers: Bose Electronics (Shanghai) Company Limited, Level 6, Tower D, No. 2337 Gudai Rd. Minhang District, Shanghai 201100 | Bose Products B.V., Gorslaan 60, 1441 RG Purmerend, The Netherlands | Bose de México S. de R.L. de C.V., Avenida Prado Sur #150, Piso 2, Interior 222 y 223, Colonia Lomas de Chapultepec V Sección, Miguel Hidalgo, Ciudad de México, C.P. 11000 Phone Number: +5255 (5202) 3545 | Bose Limited (H.K.), 7F., No. 2, Sec. 3, Minsheng E. Road, Zhongshan Dist., Taipei City 10480, Phone Number: +886-2-2514 7676 | Bose Limited, Bose House, Quayside Chatham Maritime, Chatham, Kent, ME4 4QZ, United Kingdom

Input Rating Charging Case: 5Vdc, 0.65A | **Output Voltage:** 5Vdc | **Output Current:** 75mA x2
Output Capacity: 300mAh | **IPXX Rating:** IPX4 (for the earbuds)

Input Rating Left Earbud: 5Vdc, 0.075A | **Input Rating Right Earbud:** 5Vdc, 0.075A

Model: 442318. The CMIIT ID is located on the carton.

The **Bose Terms of Use** apply to this product: [worldwide.bose.com/termsofuse](https://www.worldwide.bose.com/termsofuse)

License Disclosures: To view the license disclosures that apply to the third-party software packages included as components of the Bose QuietComfort Earbuds, use the Bose QCE app. You can access this option from the Settings menu.

Apple, the Apple logo, iPad, and iPhone are trademarks of Apple Inc., registered in the U.S. and other countries. The trademark "iPhone" is used in Japan with a license from Aiphone K.K. App Store is a service mark of Apple Inc.

Use of the Made for Apple badge means that an accessory has been designed to connect specifically to the Apple product(s) identified in the badge, and has been certified by the developer to meet Apple performance standards. Apple is not responsible for the operation of this device or its compliance with safety and regulatory standards.

The *Bluetooth*® word mark and logos are registered trademarks owned by Bluetooth SIG, Inc. and any use of such marks by Bose Corporation is under license.

Android and Google Play are trademarks of Google LLC.

Microsoft Teams is a trademark of the Microsoft group of companies.

USB Type-C® and USB-C® are registered trademarks of USB Implementers Forum.

Bose, the B logo, and QuietComfort are trademarks of Bose Corporation. | Bose Corporation Headquarters: 1-877-230-5639 | ©2024 Bose Corporation. No part of this work may be reproduced, modified, distributed, or otherwise used without prior written permission.

Please complete and retain for your records

The earbud date code is located on the earbud under the band. The charging case serial number is located on the bottom of the case. The model numbers are located on the bottom of the charging case.

Serial number: _____

Model number: 442318

Please keep your receipt. Now is a good time to register your Bose product. You can easily do this by going to [worldwide.bose.com/ProductRegistration](https://www.worldwide.bose.com/ProductRegistration)

WHAT'S IN THE BOX

Contents 11

BOSE QCE APP SETUP

Download the Bose QCE app 12

SWEAT AND WEATHER RESISTANCE 13

HOW TO WEAR

Insert the earbuds 14

Check your fit..... 15

 Eartips 15

 Stability bands..... 16

Try another size 17

 Eartips 17

 Stability bands 17

Change the eartips..... 18

Change the stability bands 19

POWER

Power on 21

 While using the earbuds 21

Power off..... 22

 While using the earbuds 22

Standby 23



TOUCH CONTROL

Media playback 24

Volume..... 25

Phone calls..... 25

 Mute a call..... 26

 Call notifications..... 26

 Sidetones..... 26

Personalize touch control..... 26

VOICE CONTROL

Use voice control 27

Personalize voice control 28

Disable voice control 28

AUDIO CONTROL

Low latency audio 29

Adjust bass and treble 29

IN-EAR DETECTION

Auto play/pause..... 30

Auto answer call 30

Auto transparency..... 30

NOISE CANCELLATION

Noise cancelling modes 31

Change the noise cancelling mode..... 31

Use noise cancellation only..... 32



BATTERY

Charge the earbuds 33

Charge the charging case..... 34

 Charge wirelessly..... 34

Check the earbud battery level..... 35

 While using the earbuds 35

 While charging the earbuds..... 35

Check the charging case battery level..... 36

Charging time 37

STATUS

Battery level..... 38

 Charging case (no earbuds) 38

 Earbuds 38

Charging status..... 39

 Charging case (no earbuds) 39

 Earbuds 39

BLUETOOTH® CONNECTIONS

Connect to a device 40

Connect an additional device..... 41

Reconnect to a device 41

Switch between two connected devices..... 41

Disconnect a device 42

Clear the earbuds device list..... 43



CARE AND MAINTENANCE

Store the earbuds	44
Clean the earbuds and charging case.....	44
Replacement parts and accessories	44
Limited warranty.....	44
Update the earbuds	45
View the earbud date code.....	45
View the charging case serial number	45

TROUBLESHOOTING

Try these solutions first.....	46
Other solutions.....	46
Reboot the earbuds	55
Restore the earbuds	55



CONTENTS

Confirm that the following parts are included:

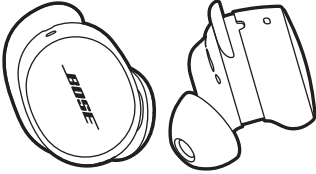

Bose QuietComfort Earbuds

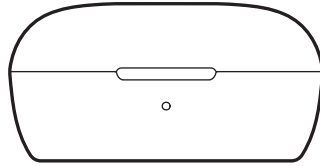

Charging case

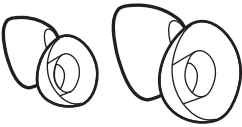

Eartips (sizes small and large)

NOTE: Medium eartips are attached to the earbuds. For help identifying the eartip sizes, see page 17.



Stability bands (sizes 2 and 3)

NOTE: Size 1 bands are attached to the earbuds. For help identifying the band sizes, see page 17.

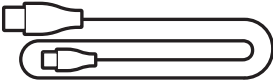

USB Type-C® to USB-A cable

NOTE: If any part of your product appears to be missing or damaged, don't use it. Visit support.bose.com/QCE for troubleshooting articles, videos, and product repair or replacement.

The Bose QCE app lets you set up and control the earbuds from your smartphone.

Using the app, you can manage *Bluetooth* connections, manage earbud settings, adjust the audio, change the voice prompt language, set an earbud to use voice control for your phone camera, and get any future updates and new features made available by Bose.

DOWNLOAD THE BOSE QCE APP

1. On your device, download the Bose QCE app.



A message displays prompting you to connect the earbuds.

2. Connect the earbuds using your device's *Bluetooth* menu (see page 40).
3. Once the earbuds are connected, follow the app instructions to add the earbuds to the Bose QCE app.

The earbuds are rated IPX4 water resistant. They are designed to be sweat and weather resistant but aren't meant to be submerged under water.

CAUTIONS:

- Do NOT swim or shower with the earbuds.
- Do NOT submerge the earbuds.

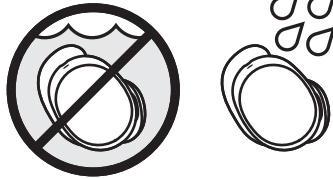

NOTES:

- To prevent corrosion, regularly clean the charging contacts on the earbuds with a dry, soft cotton swab or equivalent.
- IPX4 isn't a permanent condition, and resistance might decrease as a result of normal wear.

INSERT THE EARBUDS

1. Insert the earbud so the eartip gently rests at the opening of your ear canal.

NOTE: Each earbud is marked with either an **R** (right) or **L** (left).

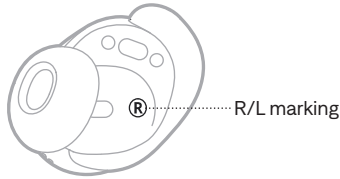

2. Slightly rotate the earbud back until the eartip creates a comfortable seal at your ear canal and the stability band rests against your ear ridge.

NOTE: You may need to rotate the earbud back and forth for the eartip to create a comfortable seal. However, rotating it too far back or forward may impact audio and microphone sound quality.

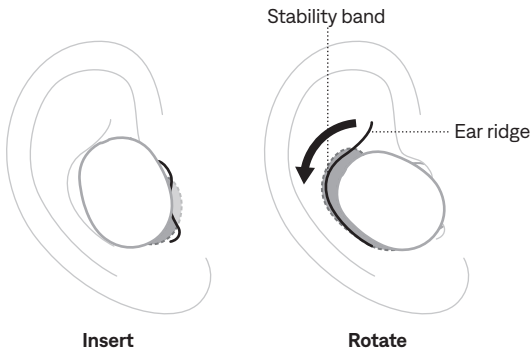



3. Check the fit (see page 15).
4. Repeat steps 1 – 3 to insert the other earbud.



CHECK YOUR FIT

For the best fit, audio performance, and noise cancellation, use a mirror to make sure you're using the correct size eartips and stability bands. You may need to try a different size eartip or stability band for each ear.

Eartips

FIT	WHAT TO CHECK
<p>Proper fit</p>	 <p>The eartip gently rests at the opening of your ear canal to create a comfortable seal. Background noise should sound muffled.</p> <p>NOTE: Noise cancellation may impact the ability to hear muffled noise.</p>
<p>Too much pressure</p>	 <p>The eartip feels uncomfortable and squished in your ear canal.</p>
<p>Too loose</p>	 <p>The eartip rests too deep in your ear canal, feels loose in your ear, or falls out when you move your head.</p>

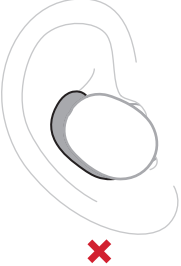
Stability bands

FIT	WHAT TO CHECK
<p>Proper fit</p>	 <p>The band doesn't stick out or feel squished against your ear ridge.</p>
<p>Too big</p>	 <p>The band is sticking out or feels squished under your ear ridge.</p>
<p>Too small</p>	 <p>The band doesn't reach your ear ridge.</p>

TRY ANOTHER SIZE

Wear the earbuds for an extended period of time. If the earbuds don't feel comfortable or secure, or noise cancellation or sound quality isn't as expected, try another size eartip or stability band.

You may need to try all three eartip or band sizes or use a different size eartip or band for each ear.

Eartips

Three sizes of eartips are included with the earbuds: small, medium, and large.

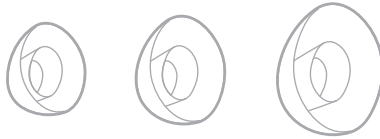

Medium eartips come attached to the earbuds. If they feel too small, try large eartips. If they feel too big, try small eartips.

Stability bands

The stability bands are marked with size **1** (small), **2** (medium), or **3** (large) and an **R** (right) or **L** (left).



Size 1 bands come attached to the earbuds. If they feel too small, try size 2 bands.

CHANGE THE EARTIPS

1. Holding the earbud, gently squeeze the eartip and peel it away from the earbud.

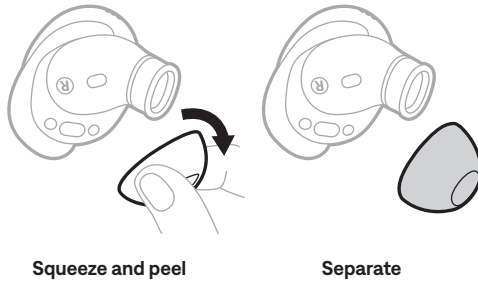

CAUTION: To prevent tearing, do NOT pull on the edge of the eartip.

2. Choose a new eartip size (see page 17).
3. Align the oval earbud nozzle with the oval eartip base, slide the eartip on the nozzle, and gently press the eartip down until you feel it click securely into place.

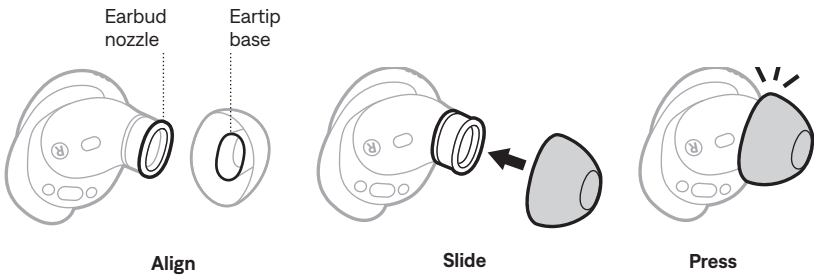

NOTE: Make sure the oval openings on the earbud and eartip are aligned in the same direction.

4. Repeat steps 1 – 3 for the other earbud, as needed.

NOTE: You may need to use a different size eartip for each ear.

5. Insert the earbuds (see page 14).
6. Check the fit (see page 15).

NOTES:

- If you change the eartip, you may need to change the stability band so the band rests comfortably against your ear ridge (see page 19).
- To see how-to videos about changing the eartips, visit: support.bose.com/QCE

CHANGE THE STABILITY BANDS

1. Holding the earbud, gently grab the stability band scoop and peel the band toward you, over the eartip, and away from the earbud.

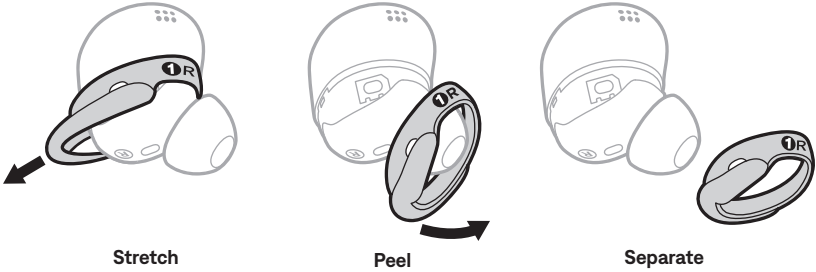

CAUTION: To prevent tearing, do NOT pull on the thin part of the band.

2. Choose a new band size (see page 17). Select the band marked with either an **R** (right) or **L** (left), depending on the earbud.
3. With the band markings facing you and the band scoop facing away from you, align the hole in the band with the vent on the earbud.
4. Gently stretch the band over the eartip, making sure the hole in the band aligns with the vent on the earbud and that the tab on the top of the band fits in the notch on the top of the earbud.
5. Press down until the band fits securely into place, then check for alignment.

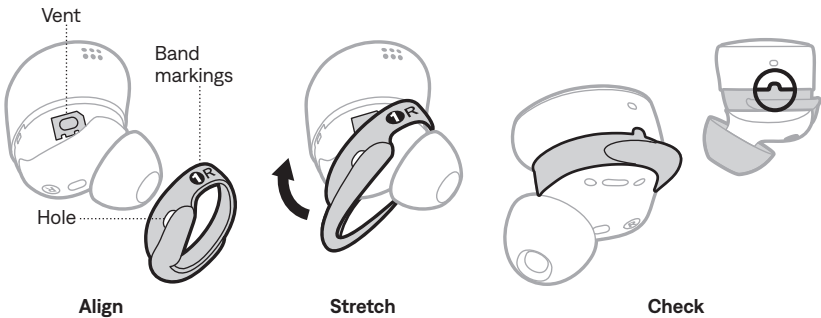

6. Repeat steps 1 – 5 for the other earbud, as needed.

NOTE: You may need to use a different size band for each ear.

7. Insert the earbuds (see page 14).

8. Check the fit (see page 15).

NOTE: To see how-to videos about changing the bands, visit: support.bose.com/QCE

POWER ON

Open the charging case.

The earbuds power on. The status light glows according to the earbuds battery level (see page 38).

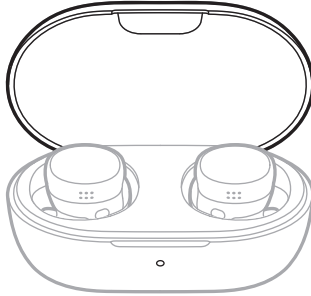

NOTES:

- The earbuds ship with a partial charge. If you're using the earbuds for the first time, you must wait until the status light starts to glow before removing them from the charging case to activate the battery. If you insert the earbuds and don't hear a voice prompt, place them back in the case and then remove them.
- When you remove the earbuds from the charging case, close the case to help preserve the battery life and keep the case free of debris.

While using the earbuds

If you're wearing the earbuds while they're powered off, touch and hold each earbud for 1 second. You hear a tone, and the earbuds power on.

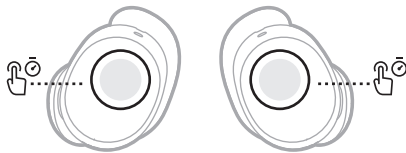

NOTE: Each earbud must be powered on individually.

POWER OFF

1. Place both earbuds in the charging case.

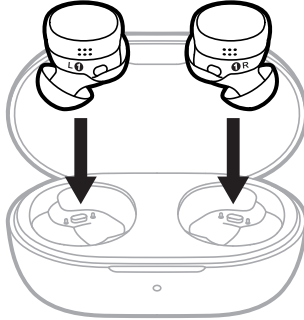

2. Close the case.

The status light glows according to the earbuds battery level (see page 38). The earbuds disconnect from your device and power off.

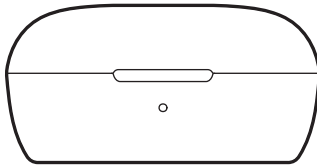

NOTE: The earbuds power after 10 minutes of being disconnected from your device, noise cancellation being off, and the controls not being used.

While using the earbuds

When you're wearing the earbuds and they're powered on, double-tap then touch and hold each earbud until you hear a tone. The earbuds power off.

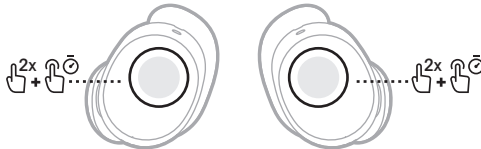

NOTE: Each earbud must be powered off individually.

STANDBY

Standby conserves the earbud battery when an earbud is out of the case and not in use. The earbud switches to Standby when you remove it from your ear and don't move it for 10 minutes.

To wake the earbud, insert the earbud in your ear.

NOTE: After 30 minutes in Standby, the earbud powers off. To power on, either place it in the charging case and then insert it in your ear or insert it in your ear and then touch and hold the earbud for 1 second.

The touch surface is located on the outer surface of both earbuds. With touch control, you can play/pause audio, change the volume, perform basic call functions, adjust the audio, and change the noise cancelling mode.

**NOTES:**

- You need to be wearing the earbuds to use touch control.
- You can use either earbud to control media playback and phone calls. When controlling volume, the left earbud and right earbud have different functions (see page 25).
- You can modify some of the touch control functions to personalize controls for your preference using the Bose QCE app (see page 26).

MEDIA PLAYBACK

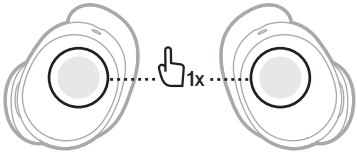
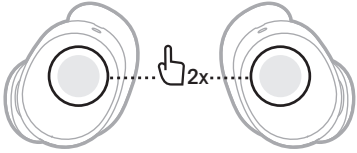
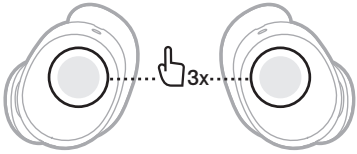
CONTROL	WHAT TO DO
Play/Pause	Tap either earbud. 
Skip to the next track	Double-tap either earbud. 
Skip to the previous track	Triple-tap either earbud NOTES: <ul style="list-style-type: none"> • If you triple-tap an earbud at the beginning of the track, the track restarts. • Interaction may vary on different devices. 

VOLUME

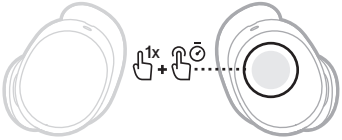
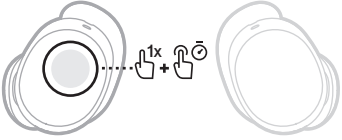
CONTROL	WHAT TO DO	
Increase the volume	Tap then touch and hold the right earbud.	
Decrease the volume	Tap then touch and hold the left earbud.	

PHONE CALLS

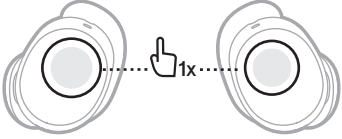
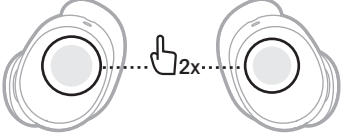
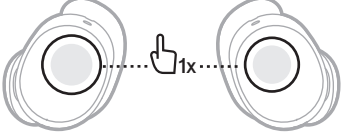
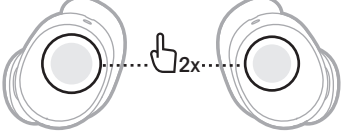
CONTROL	WHAT TO DO	
Answer a call	Tap either earbud.	
End/Decline a call	Double-tap either earbud.	
Answer a second incoming call and put the current call on hold	Tap either earbud.	
Decline a second incoming call and stay on current call	Double-tap either earbud.	

Mute a call

To quickly mute/unmute a call, use the Bose QCE app. To access this option, tap Fast Mute on the product control screen and assign a touch control.

Call notifications

You can configure your device to announce calls and call status using instructions in the Bose QCE app. To access the instructions, tap Smart Calls on the product control screen.

NOTE: You enable this feature in your device's Settings menu.

Sidetones

To hear yourself speak in your natural voice on calls or in game chats with adjustable voice amplification, use the Bose QCE app. To manage this option, tap Smart Calls on the product control screen.

PERSONALIZE TOUCH CONTROL

You can modify some of the default touch control functions to personalize controls for your preference using the Bose QCE app. To access this option, tap Touch Controls on the product control screen.

TIP: You can also modify some of the touch controls in the function screens in the Bose QCE app.

USE VOICE CONTROL

You can control the earbuds using your voice.

NOTE: You need to have the Bose QCE app running on your device (open or in the background) to use voice control.

1. Say “Hey headphones.”
You hear a tone.
2. Say your request.

CONTROL	WHAT TO SAY
Answer a call	Accept NOTE: When receiving a call, you don't need to say “Hey headphones.”
Decline a call	Reject NOTE: When declining a call, you don't need to say “Hey headphones.”
Play audio	Play
Pause audio	Pause
Skip to the next track	Next
Skip to the previous track	Previous NOTES: <ul style="list-style-type: none"> • If you say “Hey headphones, previous” at the beginning of the track, the current track restarts. • Interaction may vary on different devices.
Increase the volume	Volume up NOTE: To quickly increase the volume, say “Hey headphones, volume plus <n>” where <i>n</i> is 1, 2, 3, 4, or 5.
Decrease the volume	Volume down NOTE: To quickly decrease the volume, say “Hey headphones, volume minus <n>” where <i>n</i> is 1, 2, 3, 4, or 5.

CONTROL	WHAT TO SAY
Turn Aware mode on	Aware on
Turn Aware mode off	Aware off
Turn Quiet mode on	Quiet on
Turn Quiet mode off	Quiet off
Take a photo	Take photo NOTE: You need to have the camera app open on your device to take a photo.
Access phone assistant	Assistant <request> where <i>request</i> is the intended action.

PERSONALIZE VOICE CONTROL

To enable the earbuds to respond to only your own voice, use the Bose QCE app. To access this option, tap Voice Control on the product control screen.

DISABLE VOICE CONTROL

To disable voice control, use the Bose QCE app. To access this option, tap Voice Control or Settings on the product control screen.

LOW LATENCY AUDIO

You can enable low latency *Bluetooth* audio between your earbuds and your device to enjoy games and movies with perfectly synchronized audio. It can be enabled for each time the earbuds and your device are connected or for only a single session.

To enable low latency *Bluetooth* audio, use the Bose QCE app. To access this option, tap Low Latency Audio on the product control screen.

ADJUST BASS AND TREBLE

To adjust the bass and the treble to bring out the best in your audio or experience even more crisp dialogue, use the Bose QCE app. To access this option, tap EQ on the product control screen.

In-ear detection uses sensors to identify when you're wearing both earbuds or just a single earbud.

You can automatically play/pause audio, answer phone calls, and adjust noise cancellation by inserting or removing an earbud.

AUTO PLAY/PAUSE

When you remove an earbud, audio pauses on both earbuds.

To resume audio, reinsert the earbud.

NOTE: If you want to use a single earbud, tap the earbud in your ear to resume audio.

AUTO ANSWER CALL

You can answer phone calls by inserting an earbud.

AUTO TRANSPARENCY

When you remove an earbud, the mode adjusts to Aware mode on the earbud in your other ear.

When you reinsert the earbud, the earbud in your ear adjusts to the previous noise cancelling mode.

NOTE: You can change the noise cancelling mode on a single earbud (see page 31).

Noise cancellation reduces unwanted noise, providing a clearer, more lifelike audio performance.

You can choose between two pre-configured noise cancelling modes — Quiet or Aware — or turn noise cancellation off.

NOISE CANCELLING MODES

MODE	DESCRIPTION
Quiet (default)	Full noise cancellation with Bose-optimized audio. Allows you to block out distractions using the highest level of noise cancellation.
Aware	Full transparency with Bose-optimized audio. Allows you to hear your surroundings while enjoying your audio.
Off	Allows you to conserve battery life.

CHANGE THE NOISE CANCELLING MODE

1. Touch and hold either earbud for 1 second until you hear a tone.

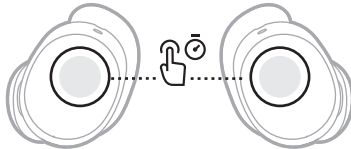

A voice prompt announces the mode.

2. Repeat until you hear the name of your preferred mode.

TIP: You can also change the noise cancelling mode using the Bose QCE app. To access this option, tap Noise Control on the product control screen.

USE NOISE CANCELLATION ONLY

You can use noise cancellation only, without audio or interruptions from phone calls.

1. Do one of the following:
 - If you're wearing the earbuds, disconnect your device (see page 42).
 - If the earbuds are in the charging case, turn the *Bluetooth* feature off on your device. Then, remove the earbuds from the case and insert them in your ears.
2. Change the noise cancelling mode (see page 31).

NOTE: To reconnect your device, select the earbuds from the *Bluetooth* list on your device.

CHARGE THE EARBUDS

NOTE: Before charging, make sure the earbuds are at room temperature, between 46° F (8° C) and 102° F (39° C).

1. Align the charging contacts on the left earbud with the charging pins on the left side of the charging case.

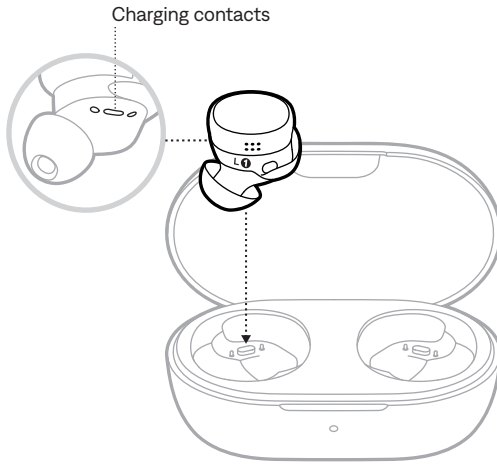

2. Place the earbud in the case until it magnetically snaps into place.
The status light glows according to the earbud's battery level (see page 38).



3. Repeat steps 1 – 2 for the right earbud.

NOTES:

- The earbuds charge if the case is open or closed.
- If you close the charging case, the earbuds disconnect from your device and power off.

CHARGE THE CHARGING CASE

CAUTION: Use this product only with an agency-approved LPS power supply that meets local regulatory requirements (e.g., UL, CSA, VDE, CCC).

NOTE: Before charging, be sure the charging case is at room temperature, between 46° F (8° C) and 102° F (39° C).

1. Connect the small end of the USB cable to the USB-C® port on the back of the charging case.

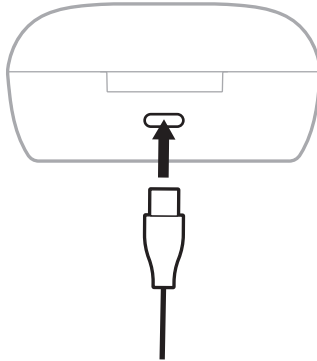

2. Connect the other end to a USB-A wall charger (not provided) or computer.
The status light glows according to the charging case status (see page 38).

Charge wirelessly

You can use a compatible third-party wireless charger (not provided) to charge the case.

Place the charging case directly in the center of your wireless charger.

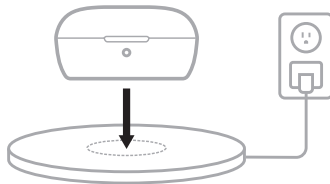

The status light glows according to the charging case charging status (see page 38).

NOTE: For more information, refer to your wireless charger owner's guide.

CHECK THE EARBUD BATTERY LEVEL

While using the earbuds

- When you remove the earbuds from the charging case and insert them into your ears, a voice prompt announces the earbud battery level.
- Use the Bose QCE app. The earbud battery level is displayed on the product control screen.

NOTE: If one earbud has a lower battery level than the other, the voice prompt announces the lower battery level. If the battery is low, you hear “Battery low.”

TIP: You can also predict how much time you have before the earbuds need to be charged. To access this option, tap Battery Prediction on the product control screen.

While charging the earbuds

When you place the earbuds into the charging case, the status light glows according to battery level (see page 38).

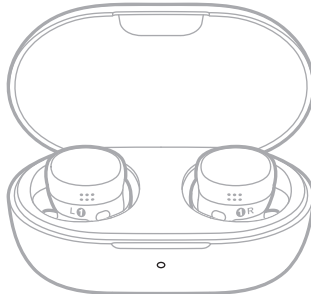

NOTE: If one earbud has a lower battery level than the other, the status light reflects the lower battery level.

CHECK THE CHARGING CASE BATTERY LEVEL

1. Open the charging case.

The status light glows according to the earbuds battery level (see page 38).

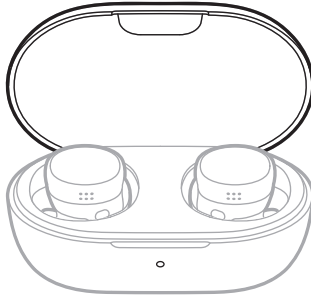

2. Remove both earbuds from the case.

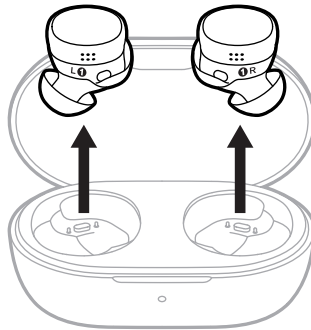

The status light glows according to the charging case battery level (see page 38).

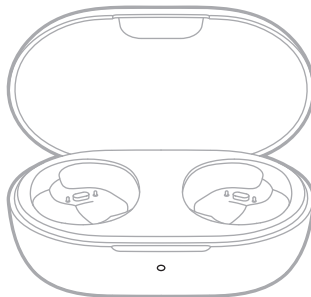

CHARGING TIME

COMPONENT	CHARGING TIME
Earbuds	Up to 1.5 hours ¹
Charging case	Up to 2 hours

NOTES:

- When the earbud battery level is low, a 20-minute charge powers the earbuds for up to 3 hours.²
- A full charge powers the earbuds for up to 8.5 hours.³
- When the case is fully charged, you can fully charge the earbuds up to 2.5 times for up to 30 hours of listening time.⁴
- When the earbuds are inside of the case, the case charging time varies.

1 Testing conducted by Bose in June 2024 using production-representative Bose QuietComfort Earbuds and Bose QuietComfort Earbuds charging case. Quick charge testing consisted of inserting earbuds with battery depleted (to the point of no audio playback) into a fully charged case and charging earbuds for 20 minutes, then resuming *Bluetooth* A2DP audio playback with volume set to loudness of 75dB SPL, 3-band EQ set to zero, in Quiet Mode (full noise cancellation), resulting in up to 3 hours playback time before battery depletion. Time to achieve fully charged earbuds was determined by inserting earbuds with battery depleted (to the point of no audio playback) into a fully charged case and charging earbuds to 100% battery charge. Battery life varies based on settings and usage.

2 See 1.

3 Testing conducted by Bose in June 2024 using production-representative Bose QuietComfort Earbuds and IEC 60268-1 pink noise using A2DP *Bluetooth* audio. Volume set to playback loudness of 75dB SPL, 3-band EQ set to zero, in Quiet Mode (full noise cancellation). Playback time was up to 8.5 hours before battery depletion. Battery life varies based on settings and usage.

4 Testing conducted by Bose in June 2024 by inserting production-representative Bose QuietComfort Earbuds with battery depleted (to the point of no audio playback) into a fully charged Bose QuietComfort Earbuds charging case and charging earbuds to 100%, then resuming audio playback until battery depletion. Testing resulted in 2.5 complete charging cycles by the case before a full charge was no longer possible.

The status light is located on the front of the charging case.

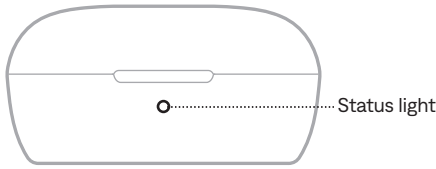

BATTERY LEVEL

Charging case (no earbuds)

Shows the charging case battery level when the case isn't connected to power and the earbuds aren't in the case.

LIGHT ACTIVITY	CASE SYSTEM STATE
Solid green (5 seconds)	High charge (81% - 100%)
Solid amber (5 seconds)	Medium charge (30% - 80%)
Solid red (5 seconds)	Low charge (1% - 29%)

Earbuds

Shows the earbud battery level when the charging case isn't connected to power and the earbuds are in the case.

LIGHT ACTIVITY	EARBUDS SYSTEM STATE
Solid green (5 seconds)	Fully charged
Slowly pulses amber (5 seconds)	Charging

CHARGING STATUS

Charging case (no earbuds)

Show the charging case charging status when the case is connected to power (by USB cable or wireless charger) and the earbuds aren't in the case.

LIGHT ACTIVITY	CASE SYSTEM STATE
Solid green	Fully charged
Slowly pulses amber	Charging

Earbuds

Show the earbuds charging status when the earbuds are in the case and the case is connected to power.

LIGHT ACTIVITY	CASE SYSTEM STATE	EARBUDS SYSTEM STATE
Solid green	Fully charged	Fully charged
Slowly pulses amber	Fully charged/charging	Charging

You can store up to five devices in the earbuds device list, and the earbuds can be actively connected to up to two devices at a time (multi-point connection). You can connect and play audio from only one device at a time.

CONNECT TO A DEVICE

1. Touch and hold either earbud for 4 seconds until you hear “Ready to pair.”

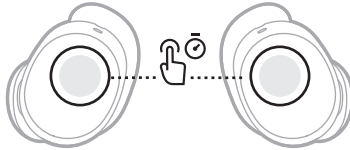

NOTE: If you are connecting the earbuds to your device for the first time, open the case and wait until the status light starts to glow before removing the earbuds. When removed, they're ready to connect. Go to step 2.

2. On your device, access *Bluetooth* settings.
3. Select the earbuds from the list of available products.

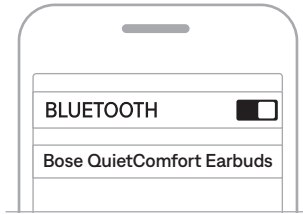

The earbuds name appears in the list of connected products.

NOTE: For the best experience, add the earbuds to the Bose QCE app (see page 12).

CONNECT AN ADDITIONAL DEVICE

The earbuds can be actively connected to two devices at a time (multi-point connection).

To connect an additional device, see page 40.

NOTES:

- You can only play audio from one device at a time.
- If two devices are already connected, the newly-connected device replaces the older of the two connections.
- To disable the multi-point connection feature using the Bose QCE app, tap Multi Point on the product control screen.
- Disabling the multi-point connection feature disconnects the second connected device.

RECONNECT TO A DEVICE

When the earbuds are removed from the case, they connect with the two most recently-connected devices.

NOTES:

- The devices must be within range (30 ft or 9 m) and powered on.
- Make sure the *Bluetooth* feature is enabled on your devices.
- If the earbuds can't connect to any previously-connected device(s) within 15 seconds, they're ready to connect to a new device.

SWITCH BETWEEN TWO CONNECTED DEVICES

1. Pause audio on your first device.
2. Play audio on your second device.

The earbuds switch to the second device's audio stream.

DISCONNECT A DEVICE

1. Place both earbuds in the charging case.

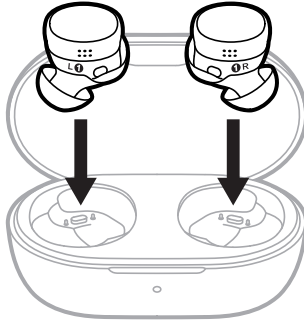

2. Close the case.

The status light glows according to the earbuds battery level (see page 38). The earbuds disconnect from your device and power off.

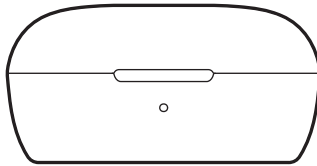

TIPS:

- You can also disconnect a second connected device using the Bose QCE app. To access this option, tap Multi Point on the product control screen.
- You can also use your device's *Bluetooth* settings. Disabling the *Bluetooth* feature on your device disconnects the earbuds and all other *Bluetooth*-connected products.
- You can also disconnect the earbuds from the Bose QCE app, but keep them connected to your device. To access this option, tap the product name in the center of the product control screen or the Settings icon on the top-right of the screen. This option doesn't apply to Android™ devices.

CLEAR THE EARBUDS DEVICE LIST

1. Make sure the earbuds aren't actively connected to any device(s).
2. Touch and hold the right earbud for 7 seconds until you hear "Ready to pair" followed by a tone. Release when you hear the tone.

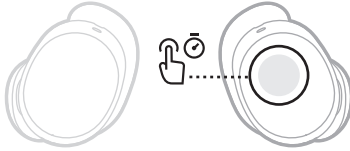

All devices are cleared, and the earbuds are ready to connect (see page 40).

STORE THE EARBUDS

When you're not using the earbuds, store them in the charging case. Close the charging case to help preserve battery life and keep the charging case free of debris.

CLEAN THE EARBUDS AND CHARGING CASE

COMPONENT	PROCEDURE
Eartips and stability bands	Remove the eartips and bands from the earbuds and wash them with a mild detergent and water. NOTE: Make sure you thoroughly rinse and dry the eartips and bands before re-attaching them to the earbuds.
Earbud nozzles	Wipe only with a dry, soft cotton swab or equivalent. CAUTION: Never insert any cleaning tool into the nozzle.
Charging contacts (on earbuds)	To prevent corrosion, wipe with a dry, soft cotton swab or equivalent.
Charging case	Wipe only with a dry, soft cotton swab or equivalent.

REPLACEMENT PARTS AND ACCESSORIES

Replacement parts and accessories can be ordered through Bose customer service.

Visit: support.Bose.com/QCE

LIMITED WARRANTY

The earbuds are covered by a limited warranty. Visit our website at worldwide.Bose.com/Warranty for details of the limited warranty.

To register your product, visit worldwide.Bose.com/ProductRegistration for instructions. Failure to register will not affect your limited warranty rights.

UPDATE THE EARBUDS

When an update is available, a message displays in the Bose QCE app on the product control screen. To begin the update, tap the message and follow the app instructions.

VIEW THE EARBUD DATE CODE

Remove the stability band from the earbud (see page 19).

The date code is located on the earbud in the wide area.

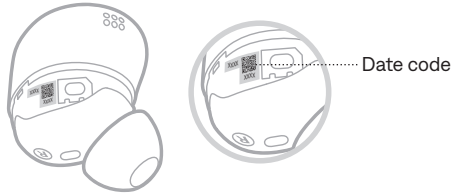

VIEW THE CHARGING CASE SERIAL NUMBER

The charging case serial number is located on the bottom of the case.

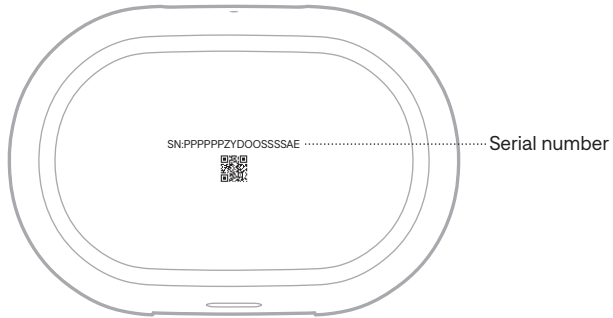

TRY THESE SOLUTIONS FIRST

If you experience problems with the earbuds, try these solutions first:

- Charge the earbuds (see page 33) and the charging case (see page 34).
- Power the earbuds off (see page 22) then on again (see page 21).
- Check the status light (see page 38).
- Make sure your device supports *Bluetooth* connections (see page 40).
- Download the Bose QCE app and run available software updates (see page 12).
- Move your device closer to the earbuds (30 ft or 9 m) and away from any interference or obstructions.
- Increase the volume on the earbuds, your device, and your music app.
- Connect another device (see page 41).

OTHER SOLUTIONS

If you could not resolve your issue, see the table below to identify symptoms and solutions to common problems. You can also access troubleshooting articles, videos, and other resources at: support.Bose.com/QCE

If you're unable to resolve your issue, contact Bose customer service.

Visit: worldwide.Bose.com/contact

SYMPTOM	SOLUTION
Earbuds don't power on	<p>If you're using the earbuds for the first time, you must wait until the status light starts to glow before removing the earbuds from the charging case to activate the battery. Place both earbuds back in the case and then remove them.</p> <p>Place both earbuds in the charging case until they magnetically snap into place. Close and re-open the case. The status light glows (see page 38).</p> <p>If you're wearing the earbuds and they're powered off, make sure you touch and hold each earbud for 1 second to power them on. They must be powered on separately.</p> <p>If the earbuds have been exposed to high or low temperatures, let the earbuds return to room temperature.</p> <p>Make sure the earbuds aren't in Standby mode. To wake the earbuds, insert the earbuds in your ears.</p> <p>See "Earbuds don't charge" on page 53.</p>

SYMPTOM	SOLUTION
Earbuds don't connect with device	<p>Place both earbuds in the charging case until they magnetically snap into place. Close and re-open the case. The status light glows (see page 38). Connect again (see page 40).</p> <p>Disable the <i>Bluetooth</i> feature on your device and then re-enable.</p> <p>Clear the earbuds device list (see page 43). Delete the earbuds from the <i>Bluetooth</i> list on your device, including any duplicate listings labeled LE (Low Energy). Connect again (see page 40).</p> <p>Visit: support.Bose.com/QCE to see how-to videos.</p> <p>Reboot the earbuds (see page 55). If that doesn't work, restore the earbuds to factory settings (see page 55).</p>
Earbuds disconnect from Bose QCE app	<p>Make sure sleep mode for the Bose QCE app is disabled on your device. For more information, refer to your device owner's guide.</p>
Earbuds don't respond during app setup	<p>Make sure the <i>Bluetooth</i> feature is on in your device's Settings menu.</p> <p>Make sure you're using the Bose QCE app (see page 12).</p> <p>Make sure you have given the Bose QCE app access to <i>Bluetooth</i> connections in your device's Settings menu.</p> <p>Close and restart the Bose QCE app.</p> <p>Uninstall the Bose QCE app on your device. Reinstall the app (see page 12).</p>
Bose QCE app can't find earbuds	<p>Make sure you're using the Bose QCE app (see page 12).</p> <p>Make sure you have given the Bose QCE app access to <i>Bluetooth</i> connections in your device's Settings menu.</p> <p>Place both earbuds in the charging case until they magnetically snap into place. Close and re-open the case. The status light glows (see page 38). Remove the earbuds.</p> <p>Connect the earbuds using the <i>Bluetooth</i> menu on your device, then open the Bose QCE app.</p> <p>If the earbuds were previously connected to a PC currently running Microsoft Teams, quit the Microsoft Teams app. If this does not resolve the issue, turn off <i>Bluetooth</i> on that PC or leave its <i>Bluetooth</i> range (30 ft or 9 m).</p> <p>See "Earbuds don't connect with device."</p> <p>Uninstall the Bose QCE app on your device. Reinstall the app (see page 12).</p>

SYMPTOM	SOLUTION
Bose QCE app doesn't work on device	<p>Make sure you're using the Bose QCE app (see page 12).</p> <p>Make sure your device is compatible with the Bose QCE app and meets minimum system requirements. For more information, refer to the app store on your device.</p> <p>Uninstall the Bose QCE app on your device. Reinstall the app (see page 12).</p>
Eartips aren't comfortable at ear canal	<p>Make sure the eartip isn't resting too deep in your ear canal (see page 15).</p> <p>Try a larger eartip. If that doesn't help, try a smaller eartip (see page 18).</p> <p>Try a smaller stability band (see page 19).</p> <p>Check the earbud fit using a mirror (see page 15).</p> <p>Visit: support.Bose.com/QCE to see how-to videos.</p>
Stability band isn't comfortable at ear ridge	<p>Try a smaller stability band (see page 19). If you're already using the smallest stability band, try a smaller eartip (see page 18).</p> <p>Check the earbud fit using a mirror (see page 15).</p> <p>Visit: support.Bose.com/QCE to see how-to videos.</p>
Earbuds aren't secure	<p>Make sure the eartip is resting gently at the opening of your ear canal (see page 14).</p> <p>Try a larger stability band (see page 19).</p> <p>Try a larger eartip (see page 18).</p> <p>Visit: support.Bose.com/QCE to see how-to videos.</p>
Eartips are falling off	<p>Make sure the eartips are securely attached to the earbuds (see page 18).</p>
Stability bands are falling off	<p>Make sure the bands are securely attached to the earbuds (see page 19).</p> <p>Make sure the bands are positioned on the earbuds correctly (see page 19).</p>
Intermittent <i>Bluetooth</i> connection	<p>Move your device closer to the earbuds.</p> <p>Clear the earbuds device list (see page 43). Delete the earbuds from the <i>Bluetooth</i> list on your device, including any duplicate listings labeled LE (Low Energy). Connect again (see page 40).</p> <p>Reboot the earbuds (see page 55). If that doesn't work, restore the earbuds to factory settings (see page 55).</p>

SYMPTOM	SOLUTION
No sound	<p>Check the earbud fit using a mirror (see page 15).</p> <p>Make sure you're using the correct eartip and band sizes for each ear (see page 17).</p> <p>Make sure that both eartips fit securely in your ear, and they aren't rotated too far back (see page 14).</p> <p>Make sure your head is upright when inserting the earbuds.</p> <p>Make sure the volume is turned up (see page 24).</p> <p>Press play on your device to make sure audio is playing.</p> <p>Play audio from a different application or music service.</p> <p>Play audio from content stored directly on your device.</p> <p>If two devices are connected, pause audio on your second device.</p> <p>If two devices are connected, disconnect your second device and play audio from your first device.</p> <p>Clear any debris or wax buildup from the eartips and earbud nozzles.</p> <p>Make sure the earbuds are charged and that there is no dirt or debris covering the charging contacts on the earbuds or the charging pins in the case.</p> <p>Visit: support.bose.com/QCE to see how-to videos.</p> <p>Restart your device.</p>
No sound from one earbud	<p>Check the earbud fit using a mirror (see page 15).</p> <p>Make sure you're using the correct eartip and band sizes for each ear (see page 17).</p> <p>Make sure that both eartips fit securely in your ear, and they aren't rotated too far back (see page 14).</p> <p>Make sure your head is upright when inserting the earbuds.</p> <p>Check the earbud fit using a mirror (see page 15).</p> <p>Make sure the software in the Bose QCE app is up to date (see page 45).</p> <p>Clear any debris or wax buildup from the eartips and earbud nozzles.</p> <p>Make sure the earbud is charged and that there is no dirt or debris covering the charging contacts on the earbuds or the charging pins in the case.</p> <p>Place both earbuds in the charging case until they magnetically snap into place. Close and re-open the case. The status light glows (see page 38). Remove the earbuds.</p> <p>Visit: support.bose.com/QCE to see how-to videos.</p>

SYMPTOM	SOLUTION
Poor sound quality	Check the earbud fit using a mirror (see page 15).
	Make sure you're using the correct eartip and band sizes for each ear (see page 17).
	Make sure you're using the Bose QCE app for setup (see page 12).
	Try a different audio track.
	Play audio from a different application or music service.
	Clear any debris or wax buildup from the eartips and earbud nozzles.
	If two devices are connected, disconnect your second device.
	Turn off any audio enhancement features on the device or music app.
	Make sure your earbuds are connected over the correct <i>Bluetooth</i> profile: Stereo A2DP. Check your device's <i>Bluetooth</i> /audio settings menu to make sure the correct audio profile is selected.
	Disable the <i>Bluetooth</i> feature on your device and then re-enable.
Clear the earbuds device list (see page 43). Delete the earbuds from the <i>Bluetooth</i> list on your device, including any duplicate listings labeled LE (Low Energy). Connect again (see page 40).	
Visit: support.bose.com/QCE to see how-to videos.	
Microphone doesn't pick up sound	Make sure the earbuds aren't rotated too far back or forward (see page 14). For the best microphone sound quality, the earbuds should be angled so that they point towards your mouth or chin.
	Make sure the stability bands are positioned on the earbuds correctly (see page 19). If the bands are positioned incorrectly, it could interfere with the microphones.
	Try another phone call.
	Try another compatible device.
	Disable the <i>Bluetooth</i> feature on your device and then re-enable.
	Clear the earbuds device list (see page 43). Delete the earbuds from the <i>Bluetooth</i> list on your device, including any duplicate listings labeled LE (Low Energy). Connect again (see page 40).

SYMPTOM	SOLUTION
Audio and video are out of sync	<p>Enable low latency <i>Bluetooth</i> audio between the earbuds and your device using the Bose QCE app. To access this option, tap Low Latency Audio on the product control screen.</p> <p>Close and re-open the application or music service.</p> <p>Play audio from a different application or music service.</p> <p>Place both earbuds in the charging case until they magnetically snap into place. Close and re-open the case. The status light glows (see page 38). Remove the earbuds.</p>
Can't adjust the noise cancelling mode	<p>Place both earbuds in the charging case until they magnetically snap into place. Close and re-open the case. The status light glows (see page 38). Remove the earbuds.</p> <p>See "Earbuds don't respond to touch control" on page 52.</p> <p>Use the Bose QCE app to adjust the noise cancelling mode. To access this option, tap Noise Control on the product control screen.</p>
Can't adjust the bass and treble	<p>On the EQ screen in the Bose QCE app, make sure you scroll to the right to view all the options. (EQ options move to the left.)</p>
Poor noise cancellation	<p>Check the earbud fit using a mirror (see page 15).</p> <p>Place both earbuds in the charging case until they magnetically snap into place. Close and re-open the case. The status light glows (see page 38). Remove the earbuds.</p> <p>Check the mode (see page 31).</p> <p>Remove the earbuds from your ears and reinsert in your ears.</p> <p>If you're on a phone call or using voice control on your device, lower or turn off voice amplification using the Bose QCE app (see page 26).</p> <p>Reboot the earbuds (see page 55). If that doesn't work, restore the earbuds to factory settings (see page 55).</p>
Difficulty hearing caller while on a phone call	<p>Increase the volume using your device.</p> <p>Using the Bose QCE app, adjust Sidetones (see page 26).</p> <p>Try a different mode (see page 31).</p>
Difficulty hearing own voice while on a phone call	<p>Change the mode to Aware mode (see page 31).</p> <p>Use the Bose QCE app to hear yourself speak in your natural voice. To access this option, tap Smart Calls on the product control screen.</p>

SYMPTOM	SOLUTION
Earbuds don't respond to touch control	<p>Make sure you're wearing the earbuds.</p> <p>Make sure you're touching the correct touch control surface (see page 25).</p> <p>Make sure your finger is making good contact with the touch control surface (see page 25).</p> <p>Make sure your fingers are dry.</p> <p>If your hair is wet, make sure it isn't interfering with the touch surface.</p> <p>If wearing gloves, remove them before touching the touch control surface.</p> <p>For multi-tap functions, vary the tap pressure.</p> <p>You can modify some of the touch control functions to personalize controls for your preference using the Bose QCE app (see page 26).</p> <p>Visit: support.Bose.com/QCE to see how-to videos.</p> <p>Place both earbuds in the charging case until they magnetically snap into place. Close and re-open the case. The status light glows (see page 38). Remove the earbuds.</p> <p>If the earbuds have been exposed to high or low temperatures, let the earbuds return to room temperature.</p> <p>Reboot the earbuds (see page 55). If that doesn't work, restore the earbuds to factory settings (see page 55).</p>
Earbuds don't respond to voice control	<p>Make sure you say your request after you hear the tone.</p> <p>Make sure the Bose QCE app is running on your device (open or in the background).</p> <p>Make sure sleep mode for the Bose QCE app is disabled on your device. For more information, refer to your device owner's guide.</p> <p>Make sure the earbuds aren't updating.</p>
Can't take photo	<p>Make sure your device supports Human Interface Device (HID) Profile and is compatible with HID headset remotes. For more information, refer to your device owner's guide.</p>
Can't adjust volume	<p>Make sure you're touching the correct touch control surface (see page 25).</p> <p>Make sure you're tapping the correct earbud (see page 25).</p> <p>See "Earbuds don't respond to touch control" on page 52.</p>

SYMPTOM	SOLUTION
Earbuds don't charge	<p>Make sure the earbuds are properly placed in the charging case. To help preserve the battery life, the case should be closed while the earbuds are charging (see page 33).</p> <p>Make sure there is no dirt or debris covering the charging contacts on the earbuds or the charging pins in the case.</p> <p>Make sure the stability bands are positioned on the earbuds correctly (see page 19). If the bands are positioned incorrectly, the charging contacts on the earbuds may not align with the charging pins in the case.</p> <p>Make sure the USB cable is correctly aligned with the port on the charging case.</p> <p>Secure both ends of the USB cable.</p> <p>Try another USB cable, wall charger, or power source.</p> <p>If the earbuds or charging case have been exposed to high or low temperatures, let the earbuds or case return to room temperature. Charge again (see page 33).</p> <p>If using a wireless charger, make sure you place the charging case directly in the center of your wireless charger to obtain a full wireless connection for charging.</p>
Charging case doesn't charge	<p>Make sure the USB cable is correctly aligned with the port on the charging case.</p> <p>If the charging case battery is fully depleted, make sure the USB cable is attached long enough for the case to gain an initial charge. If you remove the cable and the charging case status light goes out, reattach the USB cable.</p> <p>Secure both ends of the USB cable.</p> <p>Try another USB cable, wall charger, or power source.</p> <p>Make sure the charging case is closed. To help preserve the battery life, the case should be closed while it's charging.</p> <p>If the charging case has been exposed to high or low temperatures, let the case return to room temperature. Charge again (see page 34).</p> <p>If using a wireless charger, make sure you place the charging case directly in the center of your wireless charger to obtain a full wireless connection for charging.</p>

SYMPTOM	SOLUTION
Voice prompt language isn't correct	Change the voice prompt language using the Bose QCE app. You can access this option from the Settings menu.
Not receiving call notifications	<p>Make sure your device isn't set to Do Not Disturb.</p> <p>Make sure Announce Calls is enabled using the Bose QCE app. To access this option, tap Smart Calls from the product control screen.</p> <p>Make sure you have given the earbuds access to your contacts in your device's <i>Bluetooth</i> menu.</p>
Earbuds making chirping sound	<p>Make sure the earbud nozzles aren't blocked (see page 18).</p> <p>Make sure the eartips are positioned on the earbuds correctly (see page 18).</p> <p>Make sure the stability bands are positioned on the earbuds correctly (see page 19).</p>

REBOOT THE EARBUDS

If the earbuds are unresponsive, you can reboot them.

NOTE: Rebooting the earbuds doesn't clear any settings.

1. Touch and hold each earbud for 15 seconds until you hear a tone.

The earbuds power off.

NOTE: Each earbud must be powered off individually.

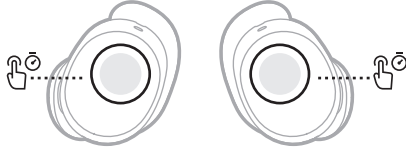

2. Touch and hold each earbud for 1 second.

You hear a tone, and the earbuds power on.

NOTE: Each earbud must be powered on individually.

RESTORE THE EARBUDS

A restore to factory settings clears all settings and return the earbuds to their original out-of-box state. After, the earbuds can be configured as if they were being set up for the first time.

Restoring to factory settings is only recommended if you are having issues with the earbuds or you have been instructed to do so by Bose customer service.

1. Make sure the earbuds aren't actively connected to any device(s).
2. Touch and hold the left earbud for 7 seconds until you hear "Ready to pair" followed by a tone. Release when you hear the tone.

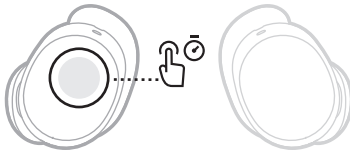

The earbuds are now restored to their original out-of-box state.



891405-0010