

beurer

HS 80



EN Straightener
Instruction for Use

CE



Read these instructions for use carefully. Observe the warnings and safety notes. Keep these instructions for use for future reference. Make the instructions for use accessible to other users. If the device is passed on, provide the instructions for use to the next user as well.

WARNING

- The device is only intended for domestic/private use, not for commercial use.
- The appliance is not to be used by persons (including children) with reduced physical, sensory or mental capabilities, or lack of experience and knowledge, unless they have been given supervision or instruction.
- Children must not play with the device.
- Cleaning and user maintenance must not be performed by children unless supervised.
- If the supply cord is damaged, it must be replaced by manufacturer, its service agent or similarly qualified persons in order to avoid a hazard.
- When using the device in the bathroom, unplug the mains plug after use as water in the vicinity constitutes a danger, even when the device is switched off.

- As an additional safety measure, we recommend the installation of a residual-current-operated protective device (RCD) with a rated operational current not exceeding 30 mA in the bathroom circuit. Your local electrical specialist can provide you with the relevant information.
- **WARNING:** Do not use this appliance near bathtubs, showers, basins or other vessels containing water.
- Under no circumstances should you open or repair the device yourself, as faultless functionality can no longer be guaranteed thereafter. Failure to comply will invalidate the warranty.

Contents

1. Included in delivery	3	7. Usage	8
2. Signs and symbols	4	8. Cleaning and maintenance.....	10
3. Intended use.....	5	9. Disposal.....	10
4. Warnings and safety notes.....	5	10. Technical specifications	11
5. Device description.....	7	11. Warranty / Service	11
6. Initial use	7		

















1. Included in delivery

Check that the exterior of the cardboard delivery packaging is intact and make sure that all contents are present. Before use, ensure that there is no visible damage to the device or accessories and that all packaging material has been removed. If you have any doubts, do not use the device and contact your retailer or the specified Customer Service address.

- 1 x Straightener
- 1 x Storage pouch
- 1 x This instruction manual

2. Signs and symbols

The following symbols are used on the device, in these instructions for use, on the packaging and on the type plate for the device:

	Warning Warning instruction indicating a risk of injury or damage to health		Manufacturer
	Important Safety note indicating possible damage to the device/accessory		Product information Note on important information
	WARNING Do not use this appliance near bathtubs, showers, basins or other vessels containing water.		Certification symbol for products that are exported to the Russian Federation and members of the CIS
	Read the instructions		Marking to identify the packaging material. A = Material code, B = Material number: 1-7 = Plastics, 20-22 = Paper and cardboard
	Disposal in accordance with the Waste Electrical and Electronic Equipment EC Directive – WEEE		CE labelling This product satisfies the requirements of the applicable European and national directives.
	Protection class II device The device is double-protected and thus corresponds to protection class 2		Separate the product and packaging elements and dispose of them in accordance with local regulations.
	Importer symbol		United Kingdom Conformity Assessed Mark
	Separate the packaging elements and dispose of them in accordance with local regulations.		Serbian mark of conformity

3. Intended use

The straightener must be used only for individual, private straightening and shaping of hair!



Warning

Use the unit only:

- For external use
- For the purpose for which it was developed and in the manner specified in these instructions for use.

Any improper use can be dangerous!

4. Warnings and safety notes



Danger

To avoid damage to health, we strongly advise against using the device in the following situations:

- Never submerge the device in water or other liquids! Risk of electric shock!
- If the device should fall into water despite following all safety precautions, immediately pull the mains plug from the socket. Do not reach into the water! Risk of electric shock!
- Have the device checked by an authorised specialist workshop before using it again. Danger to life due to electric shock!
- If the device has been dropped or suffered any other damage, it must no longer be used. Risk of electric shock and risk of injury!
- If there is visible damage to the device, mains cable/plug or accessories. If you have any doubts, do not use the device and contact your retailer or the specified Customer Services address. Risk of electric shock!
- Keep packaging material away from children – risk of suffocation!
- Do not use extension cables in the bathroom to ensure the mains plug can be accessed quickly in an emergency.



Warning

To avoid damage to health, please note the following:

- Ensure that no highly flammable liquids are located near the device. Risk of fire!
- Place the device on fireproof surfaces only. Risk of fire!
- The hair straightener must not be covered – risk of fire!
- Do not use the device on synthetic hair – risk of fire!
- Burn hazard. Keep appliance out of reach from young children, particularly during use and cool down

- When the appliance is connected to the power supply, never leave it unattended

Notes

- Remove all packaging material before using the device.
- Only connect the device to a socket that has the voltage shown on the type plate.
- Only pull the mains cable from the socket by the mains plug.
- Do not use any additional parts that are not recommended by the manufacturer or offered as accessories.
- Under no circumstances should you open or repair the device yourself, as faultless functionality can no longer be guaranteed thereafter. Failure to comply will invalidate the warranty.
- In the event of a fault or damage, have the device repaired by a certified specialist workshop.
- Never leave the device unattended during use.
- Do not use the device outside.
- If you pass the device on to someone else, make sure to also pass on these instructions for use.

5. Device description

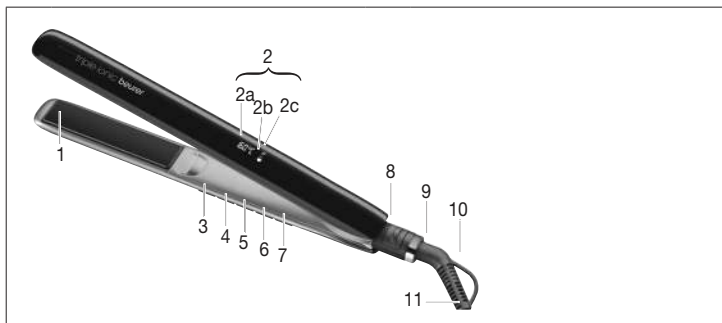

1	Titanium-coated hot plates	5	Button for decreasing the temperature (-)
2	MAGIC LED display	6	Button for increasing the temperature (+)
2a	Temperature display	7	On/off switch
2b	Ion display	8	Plate locking system
2c	Protection function	9	360° swivel joint with anti-kink protection
3	Button to set the ion intensity	10	Hanging eyelet
4	Button to switch on the protection function	11	Mains cable

6. Initial use



Warning

- Position yourself on a dry, non-conductive surface. Risk of electric shock!
- Ensure that your hands are dry. Risk of electric shock!
- Your hair must be dry! Risk of electric shock!
- The device can become very hot depending on the temperature setting and the duration of use. When the device is hot, it must only be held using the handle – risk of burns and fire!
- Do not touch the hot plates [1]. Risk of burns!
- Do not clamp objects between the hot plates [1].
- Switch the device off immediately if it is faulty or not working properly.

Important



- Untangle the mains cable [11] if it is twisted.
- Do not pull, twist or bend the mains cable [11] and do not pull or route it over/on sharp, pointed objects or hot surfaces.
- Do not jam the mains cable [11] in drawers or doors, for example. The risk of electric shock is increased if the mains cable is damaged or tangled.

7. Usage

Straightening/shaping hair

- > Unlock the hair straightener by moving the lock button [8] to the open position.
- > Press the on/off switch for two seconds [7].
 - The unit is shipped with a default temperature setting for normal hair (100 °C).
 - The heat-up phase is shown by the flashing °C symbol [2a].
 - The selected temperature has been reached if the °C symbol is continuously illuminated [2a].
 - After about 30 seconds, the straightener is ready for use.

Adjusting the temperature

- > You can increase or decrease the temperature in 20 °C increments using the +/- buttons [5, 6].
- > The current temperature setting is shown on the LED temperature display [2]. The temperature can be fixed by pressing the on/off switch [7] twice. The locked symbol  appears on the display. You can only switch off the hair straighteners if the button lock is deactivated. To deactivate the button lock, press the on/off switch [7] again twice. The locked symbol  goes out.
- > We recommend the following temperature settings:
 - > 100 °C to 140 °C:
 - Fine, fragile, coloured or bleached hair
 - > 160 °C to 180 °C:
 - Normal hair
 - > 200 °C to 220 °C:
 - Strong and resistant hair

Select the ion intensity

- > The intensity of the ions can be selected using the ion button [3]:
- > Select the ion intensity:
 - 0 No ions for particularly thin hair
 - 1 Low level of ions for fine hair
 - 2 High level of ions for relatively thick and frizzy hair



- > Dry your hair completely before using the straightener.
- > Your hair should be clean and free of styling products. Exceptions to this are special products that aid straightening of the hair.
- > Comb your hair with a wide-toothed comb to untangle it.
- > Divide your hair into individual strands with a width of about 3 to 4 cm. Hold the strands taut and place them between the heating plates [1] at the roots.
- > Move the straightener slowly and smoothly from the roots to the ends. Do not keep the straightener at any one place for longer than two seconds. This way you will obtain the best results without overstraining or damaging your hair.
- > You can shape the ends by twisting the straightener either outward or inward before you pull it out over the ends.

Note

- The higher the selected temperature, the more quickly you get the desired result.
- If you work with the maximum temperature, do not work on the same strands more than once.

Select function

The hair straightener has 2 functions:

Function	Description
Protect function 	For gently straightening hair. The temperature is restricted to approx. 160°C and kept constant; the ions are set at level 1 [4].
Memory function 	It is used for storing the preferred, individually selected temperature setting. The hair straightener automatically stores the last temperature set.

Note

- Automatic shutoff:
For your safety, the straightener shuts off automatically after 30 minutes.

After use

- > Press the on/off switch. The straightener shuts off.
- > Place the straightener on a non-combustible surface.
- > Remove the plug from the socket after each use.
- > Let the unit cool down.
- > Do not wind the mains cable around the unit!

- > Store the unit in a dry place that is out of reach of children.
- > The unit can be hung on a hook by the hanging eyelet [10].
- > The device can be stored and transported in the heat-resistant storage pouch.

8. Cleaning and maintenance

Cleaning



Warning

- Always pull the mains plug out of the socket before cleaning the device. Risk of electric shock!
- Ensure that no water gets inside the device. Risk of electric shock!
- Do not clean the device with highly flammable liquids! Risk of fire!



Note

- Your device is maintenance-free.
- Protect the device from dust, dirt and humidity.
- Do not clean the device in a dishwasher.
- Do not use any aggressive, caustic, abrasive or corrosive cleaning products or hard brushes.
- The casing of the hair straightener and the hot plates may be cleaned with a soft cloth dampened with warm water.

9. Disposal

In the interest of protecting the environment, the unit must not be thrown out with the household waste at the end of its service life.

Dispose of the unit at a suitable local collection or recycling point.

Observe the local regulations for material disposal.

Please dispose of the device in accordance with EC Directive – WEEE (Waste Electrical and Electronic Equipment).

If you have any queries, please contact the appropriate local authorities.

You can find out about collection points for your old units e.g. from the local municipal government, the local waste disposal company or your dealer.



10. Technical specifications

Weight	Approx. 390 g
Power supply	220-240 V~, 50-60 Hz
Power consumption	45 W
Temperature range	100-220 °C
Safety class	II
Ambient conditions	Only approved for indoor use
Allowable temperature range	-10 to +40 °C

Subject to technical modifications.

11. Warranty / Service

Further information on the warranty and warranty conditions can be found in the warranty leaflet supplied.



Beurer GmbH • Söflinger Str. 218 • 89077 Ulm, Germany
www.beurer.com • beurer.healthguide.com



UK-Importer: Beurer UK Ltd.
Suite 16, Stonecross Place • Yew Tree Way • WA3 2SH Golborne
United Kingdom



591.00_HS80_2024-06-25_04_IM1_BEU_EN